

**PLUM CREEK  
LOCAL FLOOD  
PROTECTION PROJECT  
WICHITA FALLS, TEXAS**

***DETAILED PROJECT REPORT  
AND  
ENVIRONMENTAL ASSESSMENT***



**US Army Corps  
of Engineers**

Southwestern Division  
Tulsa District

JUNE 1992

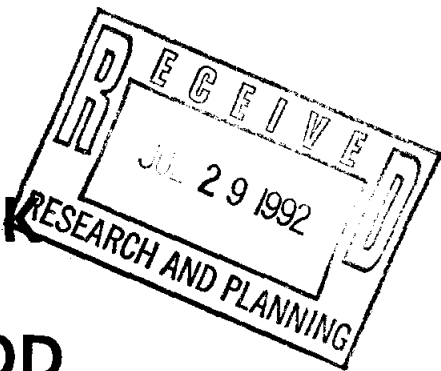

**PLUM CREEK  
LOCAL FLOOD  
PROTECTION PROJECT  
WICHITA FALLS, TEXAS**

***DETAILED PROJECT REPORT  
AND  
ENVIRONMENTAL ASSESSMENT***



**US Army Corps  
of Engineers**

Southwestern Division  
Tulsa District

JUNE 1992

**PLUM CREEK  
LOCAL FLOOD PROTECTION PROJECT  
WICHITA FALLS, TEXAS**

**DETAILED PROJECT REPORT  
AND  
ENVIRONMENTAL ASSESSMENT**

**U.S. Army Corps of Engineers  
Southwestern Division  
Tulsa District**

**June 1992**

## SYLLABUS

This report presents the results of detailed studies to identify the best plan to provide flood protection along Plum Creek in Wichita Falls, Texas. The study was requested by the mayor of the city of Wichita Falls and was conducted under the authority of Section 205 of the 1948 Flood Control Act, as amended.

Plum Creek is a tributary of the Wichita River. It originates in the northwest portion of the city of Wichita Falls and flows in a southerly direction to its confluence with the Wichita River. The drainage area of the mainstem is 7.5 square miles and is uncontrolled. The upper portion of the watershed is undeveloped agricultural land; the middle portion is a highly developed residential area with scattered commercial development; and the lower reach is predominantly agricultural land. Flood damages occur primarily in the middle reach.

Most of the flooding along Plum Creek is the result of intense rainfall from thunderstorms that usually occur from April through October. Flooding along Plum Creek could cause an estimated \$526,700 in average annual damages based on March 1992 price levels.

A plan to provide upstream dry detention was identified as the National Economic Development plan. The principal features of this plan are an earthfill dam with uncontrolled spillway, uncontrolled outlet works, and supporting facilities. A grass-lined emergency spillway with a concrete sill at the crest would be located in the left abutment. The uncontrolled outlet structure would be a 30-inch-diameter, reinforced concrete pipe. The outlet channel would be about 400 feet long, with 18-inch riprap extending 50 feet downstream of the headwall apron. The remainder of the channel would be grass-lined, as is the 170-foot-long inlet channel.

The estimated first cost of the project, based on 8-1/2% interest and March 1992 prices, is \$2,406,000. Interest during construction is estimated at \$72,100 for a total gross investment of \$2,478,100. The average annual cost would be \$223,300, including \$9,000 for operation and maintenance. The average annual benefits would be \$498,500. The project is economically feasible with a benefit-to-cost ratio of 2.2. The cost of the project, inflated through construction (October 1996), is estimated to be \$2,687,500, of which the Federal share would be \$2,105,625, and the non-Federal share would be \$671,875.

# PLUM CREEK LOCAL FLOOD PROTECTION PROJECT WICHITA FALLS, TEXAS

## TABLE OF CONTENTS

	<u>Page</u>
INTRODUCTION . . . . .	1
Study Authority . . . . .	1
Study Purpose . . . . .	1
Cost-Sharing Agreement . . . . .	1
Study Management . . . . .	2
Study Area . . . . .	2
Prior Studies and Report . . . . .	2
Detailed Project Report . . . . .	2
Post-Flood Report . . . . .	2
Flood Insurance Study . . . . .	4
PROBLEM IDENTIFICATION . . . . .	5
Description of the Watershed . . . . .	5
Environmental Setting . . . . .	5
Land Use . . . . .	5
Terrestrial and Aquatic Resources . . . . .	5
Endangered Species . . . . .	6
Cultural Resources . . . . .	7
Flooding Problem . . . . .	7
Flood History . . . . .	7
Flood-Prone Area . . . . .	7
Future Conditions Without Federal Action . . . . .	9
PLAN FORMULATION . . . . .	10
Problem and Opportunity Statements . . . . .	10
Planning Constraints . . . . .	10
Alternative Plan Analysis . . . . .	11
Formulation Process . . . . .	11
Preliminary Plans . . . . .	12
Plans Considered in Detail . . . . .	12
Channel Alternative . . . . .	12
Detention Alternative . . . . .	15
Selected Plan . . . . .	15

TABLE OF CONTENTS (Continued)

	<u>Page</u>
DESCRIPTION OF SELECTED PLAN . . . . .	18
General Design Data . . . . .	18
Mitigation Plan . . . . .	21
Section 404 Determination . . . . .	22
Real Estate Requirements . . . . .	22
Relocations Requirements . . . . .	22
Costs of Selected Plan . . . . .	24
Operation and Maintenance of Selected Plan . . . . .	24
Plan Accomplishments . . . . .	25
Benefit Analysis of the Selected Plan . . . . .	25
Benefit-to-Cost Ratio . . . . .	26
Summary of Environmental, Economic, and Other Social Effects . . . . .	27
PLAN IMPLEMENTATION . . . . .	29
Institutional Requirements . . . . .	29
Division of Responsibilities . . . . .	29
Local Sponsor . . . . .	29
Federal . . . . .	29
Project Cost Sharing Requirements . . . . .	29
Hazardous and Toxic Waste Survey . . . . .	31
Project Schedule . . . . .	31
Views of Local Sponsor . . . . .	31
SUMMARY OF COORDINATION, PUBLIC VIEWS, AND COMMENTS . . . . .	32
Coordination With Sponsor . . . . .	32
Coordination With Other Agencies and Public Entities . . . . .	32
RECOMMENDATIONS . . . . .	33
DISCLAIMER . . . . .	35
FINDING OF NO SIGNIFICANT IMPACT	
ENVIRONMENTAL ASSESSMENT	

TABLE OF CONTENTS (Continued)

Page

LIST OF TABLES

1	Summary of Flood Control Benefits Channel Plan . . . . .	14
2	Preliminary Net Benefits . . . . .	17
3	Pertinent Data, Upstream Dry Detention . . . . .	20
4	Summary of Estimated Costs . . . . .	24
5	Summary of Annual Flood Control Benefits . . . . .	26
6	Investment and Annual Charges . . . . .	27
7	Summary of Project Economics Selected Plan . . . . .	28
8	Project Costs . . . . .	30
9	Project Cost Sharing Responsibilities . . . . .	30

LIST OF FIGURES

1	Study Area . . . . .	3
2	Flood-Prone Area . . . . .	8
3	Channel Improvement Plan . . . . .	13
4	Preliminary Net Benefits Versus Frequency . . . . .	16
5	Recommended Plan - Upstream Dry Detention . . . . .	19
6	Proposed Mitigation Area . . . . .	23

LIST OF APPENDICES

1	Hydrology and Hydraulics
2	Economic and Social Analysis
3	Real Estate Supplement
4	Geology and Soils
5	Design and Cost Estimates
6	U.S. Fish and Wildlife Service Coordination Act Report
7	Financial Capability Analysis
8	Section 404 Determination
9	Pertinent Correspondence
10	Letter of Intent

# **PLUM CREEK LOCAL FLOOD PROTECTION PROJECT WICHITA FALLS, TEXAS**

## **INTRODUCTION**

This report presents the findings of a detailed study of Plum Creek in Wichita Falls, Texas, to identify a project that will provide flood protection. The mayor of Wichita Falls, in his letter dated May 7, 1987, requested Federal assistance with the flood problems that occur along Plum Creek.

## **STUDY AUTHORITY**

This study was conducted under the authority of Section 205 of the 1948 Flood Control Act, as amended by Section 915 of Public Law 99-662. The text of the authority reads as follows:

The Secretary of the Army is hereby authorized to allot from any appropriations heretofore and hereafter for flood control, not to exceed \$40,000,000 for any one fiscal year, for the construction of small projects for flood control and related purposes not specifically authorized by Congress, which come within the provisions of Section 1 of the Flood Control Act of June 22, 1936, when in the opinion of the Chief of Engineers such work is advisable. The amount allotted for a project shall be sufficient to complete Federal participation in the project. Not more than \$5,000,000 shall be allotted under this section for a project at any single locality. The provisions of local cooperation specified in Section 3 of the Flood Control Act of June 22, 1936, as amended, shall apply. The work shall be complete in itself and not commit the United States to any additional improvement to insure its successful operation, except as may result from the normal procedure applying to projects authorized after submission of preliminary examination and survey reports.

## **STUDY PURPOSE**

The purpose of this study was to determine the best plan for providing flood protection along Plum Creek.

## **Cost-Sharing Agreement**

The Water Resources Development Act of 1986 (Public Law 99-662) requires equal cost sharing by the Federal Government and a local sponsor of the costs of conducting feasibility studies of local flood protection projects. At the conclusion of the reconnaissance phase of the study in January 1990, the city of



Wichita Falls agreed to continue the study and be the local cost-sharing partner. The city and the Federal Government signed a Feasibility Cost-Sharing Agreement on May 21, 1990. Costs of the study borne equally required \$200,000 from the Federal Government and \$200,000 (\$170,000 in cash and \$30,000 in-kind services) from the city.

### **Study Management**

The study agreement between the Federal Government and the city of Wichita Falls provided a team approach to study management and coordination. Overall study management was the responsibility of an Executive Committee, consisting of the Tulsa District Engineer; the Tulsa District Chief, Planning Division; the Director of Public Works for the city of Wichita Falls; and the City Engineer. The Executive Committee, in turn, appointed representatives to serve on a Study Management Team. The Study Management Team was delegated responsibility for the day-to-day activities of the study and for preparing and submitting monthly progress reports to the Executive Committee. The Study Management Team met monthly to discuss progress.

### **STUDY AREA**

The main branch of Plum Creek heads in Wichita County in east central Texas, about 2.5 miles west of Sheppard Air Force Base (Figure 1). Plum Creek is located northwest of the intersection of Interstate 44 and U.S. Highway 287. The stream flows south approximately 6 miles to its confluence with the Wichita River. Plum Creek has three main tributaries; all are characterized as seasonally intermittent, low order streams. Collectively, Plum Creek and its tributaries drain about 17.5 square miles. The watershed of the main branch drains about 7.5 square miles.

### **PRIOR STUDIES AND REPORTS**

#### **Detailed Project Report**

In 1963, the Tulsa District, Corps of Engineers completed a Detailed Project Report (DPR) which summarized a detailed study of the flood problems in the Plum Creek watershed. The DPR recommended that about 8 miles of channel be enlarged. The city was unable to cost share in the recommended plan, but officially adopted the approved DPR as a master drainage plan.

#### **Post-Flood Report**

Tulsa District prepared a post-flood report of the May 12-14, 1982, flood in Wichita Falls. Although flooding occurred along Plum Creek, the worst flooding was along McGrath Creek where rainfall amounts of 10 inches were recorded.

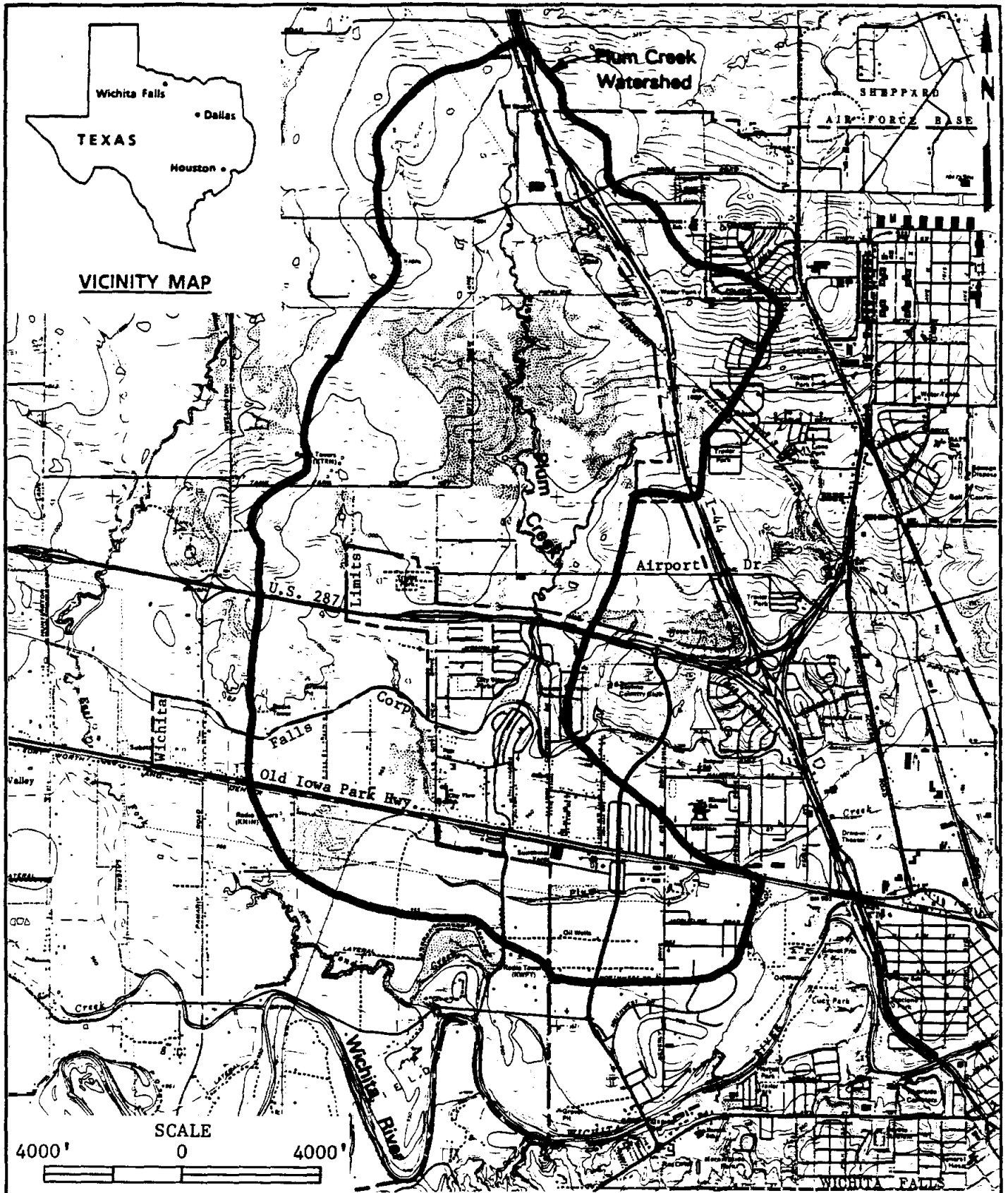

Figure 1  
Study Area

## **Flood Insurance Study**

In March 1977, the Tulsa District, Corps of Engineers completed a flood insurance study of the city of Wichita Falls for the Federal Insurance Administration, U.S. Department of Housing and Urban Development. The flood insurance study outlined the floodway, the 100-year floodplain, and the 500-year floodplain. Tulsa District updated the 1977 flood insurance study in 1989.

## PROBLEM IDENTIFICATION

### DESCRIPTION OF THE WATERSHED

The terrain of the watershed consists of gently rolling hills on uplands and narrow, nearly level floodplains along creeks and small drainageways. Elevations range from 930 to 1,085 feet above mean sea level. Soils in the study area consist of moderately deep, loamy soils with some gravelly and stony loams in upland areas, and deep loamy soils along the creek. Plum Creek and its tributaries are characterized as seasonally intermittent, low order streams.

### ENVIRONMENTAL SETTING

#### Land Use

Dominant land uses along the main branch of Plum Creek are agriculture and urban development. In the upper segment of the creek, mesquite grasslands; steeper, gravelly uplands; and drainageways are used for grazing livestock. On the more level upland areas, some wheat cultivation occurs. Urban development is largely confined to the middle reach of the creek where channelization has occurred. Both developed and undeveloped agricultural land comprise the lower reaches of the watershed.

#### Terrestrial and Aquatic Resources

The study area is situated in the mesquite-buffalo grass section of the Prairie Brushland Ecoregion (Bailey 1980). Wildlife populations in the Plum Creek watershed are currently limited by existing land use patterns and by the overall moderate carrying capacity of the habitat. Urbanization has resulted in continual loss and degradation of quality wildlife habitat. Urban development in the lower reaches of Plum Creek restricts the best remaining wildlife habitat to the riparian zones and to the mesquite grasslands of the upper reaches of the creek.

Riparian timber zones are characterized by an overstory of trees, such as hackberry, American elm, black willow, and bumelia. The understory consists mainly of grasses, vines, and herbaceous plants. These narrow riparian zones are valuable as protective cover for migrating and dispersing wildlife, and as nesting habitat for resident songbirds. Small mammals, such as raccoons, fox squirrels, opossums, skunks, rats, and mice, are also associated with riparian zones.

Riparian zones typically have a greater quantity and diversity of vegetation than adjoining land. These areas remove sediment from runoff water as it moves through the vegetation, thus helping to purify water and enrich the riparian zone. They act as sponges by holding water in streambanks, thereby raising the water table in

the surrounding area and providing a more stable stream flow. During floods, healthy riparian areas dissipate the energy of flood waters and reduce flood peaks. Riparian areas provide food, water, shade, and cover for fish and wildlife, and forage for wild and domestic grazing animals, as well as recreational opportunities.

The acreage of mesquite grasslands far exceeds that of riparian zones in the project area. The mesquite grassland areas are characterized by scattered mesquite and wild plum thickets. The grass community is typified by sideoats grama, little bluestem, blue grama, and buffalo grass. These mesquite grassland areas provide good quality habitat for such species as white-tailed deer, eastern cottontail, and coyote. They also provide nesting habitat for migratory and non-migratory birds. The most productive upland terrestrial habitats generally occur in prairie-to-riparian transition zones where wildlife species can use food and cover provided by both cover types.

Plum Creek is an intermittent stream; therefore, aquatic resources are minimal in the upper reaches. Stream quality is also influenced by agricultural runoff. In the lower reaches, bank disturbances, channel modification, and urban runoff have virtually eliminated aquatic resources.

Lands within the study area are mostly privately held, which limits opportunities for public-oriented fishing and wildlife recreation.

### **Endangered Species**

Federally-listed threatened or endangered species that might occur in the study area are the least tern (*Sterna antillarum*), the whooping crane (*Grus americana*), and the piping plover (*Charadrius melodus*). The whooping crane and the piping plover migrate through Wichita County; the least tern is known to nest in suitable habitat along the Red River. It is unlikely that these species would utilize the Plum Creek watershed. The U.S. Fish and Wildlife Service concluded the project would not impact these species.

A search of the Texas Natural Heritage Program Information System revealed that the Texas Kangaroo Rat (*Dipodomys elator*) resides in the general area of the project. The Texas Kangaroo Rat is listed as a Federal category 2 candidate species and as a State threatened species. A Federal candidate species has no legal protection under the Endangered Species Act. In the summer of 1990, biologists from the Corps of Engineers and the U.S. Fish and Wildlife Service performed a cursory evaluation of the detention site to determine if habitat for the Texas Kangaroo Rat was present. The site did not contain habitat for the rat, as described in current literature, and no burrows were found near the base of the mesquite trees. A trapping survey would be necessary to accurately determine the presence or absence of the species.

## **Cultural Resources**

Based on a field investigation of the site in December 1988, Corps archaeologists determined that the area was already disturbed by prior land use activities. No archeological or cultural resources were located at the site, and there are no sites in the project area listed on the National Register of Historic Places.

## **FLOODING PROBLEM**

### **Flood History**

Most floods within the study area are caused by intense rainfall associated with thunderstorms. While thunderstorms can occur at any time during the year, they are prevalent from April through October. Overflows along Plum Creek generally result from rapidly rising waters after intense, localized rainfall over the watershed. Within a few hours after the storm, channel flows recede to channel capacity.

There are no stream gaging stations in the Plum Creek basin; therefore, historical information about specific basin flooding is limited. Data from the one official hourly recording precipitation gage in the Wichita Falls area does provide some information about storms that have occurred in the area. Major storms have been recorded at the Wichita Falls gage since May 1940 (Appendix 1). Recent flood events occurred in May 1982 and June 1985. The maximum flood of record occurred on October 29, 1941, when 6.4 inches of rain fell in a 24-hour period. Runoff from the storm flooded 560 acres of urban and adjacent lands. The average yearly precipitation for Wichita Falls is 28 inches.

### **Flood-Prone Area**

The flood-prone area is shown on Figure 2. The study area is composed of commercial, industrial, residential, public, and semi-public properties. The floodplain inventory conducted during July 1991 identified 8 commercial, 2 industrial, 414 residential, 8 public (e.g., schools), and 1 semi-public (church) structure within the 500-year floodplain. The Marshall and Swift Depreciated Replacement Value methodology, used during the economic studies (Appendix 2), established a total value for contents and structures within the 500-year floodplain at \$26 million. Damages begin to occur to structures in most of the study area at the elevation corresponding to the 5-year flood event. Potential single-occurrence damages range from \$388,500 for a 5-year event to \$6.5 million for the flood event that has a 1% chance of occurring in any given year (100-year event). The flood event that has a 2% chance of occurring in any given year (50-year storm) would produce damages to structures and contents estimated at \$5.3 million. The flood losses expected to occur under existing conditions, expressed as an average annual loss (or damage), is estimated at \$526,700.

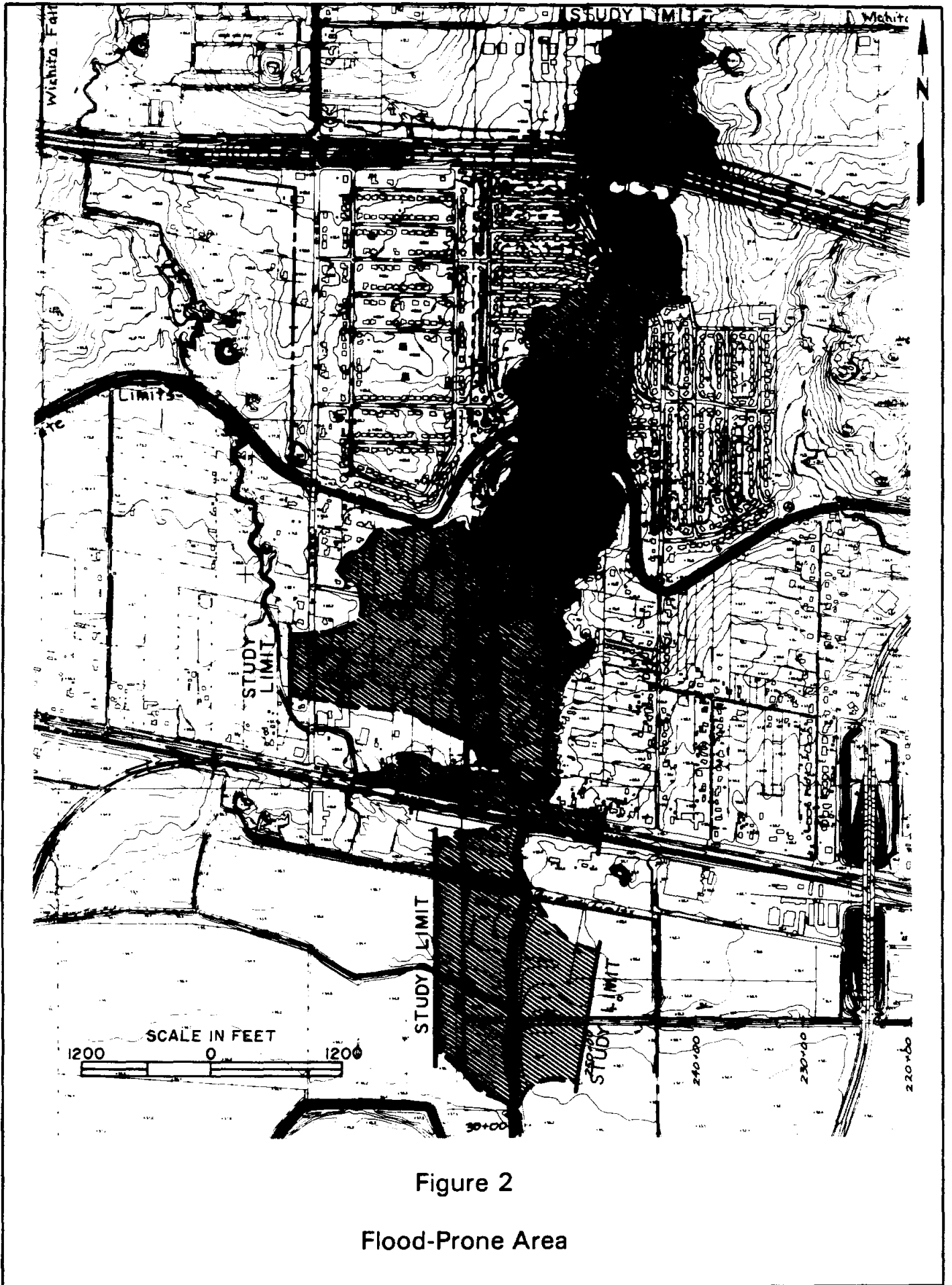

Figure 2

Flood-Prone Area

## **FUTURE CONDITIONS WITHOUT FEDERAL ACTION**

The city of Wichita Falls is enrolled in the National Flood Insurance Program. Floodplain management regulations required by the program, along with population projections and economic trends, are major determinants of future conditions.

Since 1980, the city has increased in population only slightly (Appendix 2). The metropolitan area experienced considerable growth during the 1960s, but the population has declined somewhat since the 1960s to its current census of about 96,260 persons.

The city of Wichita Falls will continue to experience flooding from overflows along Plum Creek. If development occurs within the upper watershed, an increase in runoff will occur during rainfall events. The types of flood control measures that could be implemented within the upper watershed would limit development, thereby restricting the city to more costly measures, such as channel improvements.



## **PLAN FORMULATION**

### **PROBLEM AND OPPORTUNITY STATEMENTS**

Problem and opportunity statements are based on the identified problems and needs of the study area and reflect the national concern for improving national economic development and enhancing environmental quality.

The alternative plans developed in the Plum Creek study should:

1. Contribute to improved physical, emotional, and economic health, safety, and well-being by reducing flood damages attributed to flooding along Plum Creek.
2. Contribute to environmental and life quality by preserving or recreating aquatic habitat, open space, and greenbelts in the project area.

### **PLANNING CONSTRAINTS**

Solutions to reducing the flood problem along Plum Creek must be technically sound, environmentally and economically feasible, and locally acceptable. Identification of solutions are limited by specific planning constraints.

1. Section 205 studies are limited to addressing flood control problems and recreational and environmental needs.
2. Federal expenditures for Section 205 projects are limited to \$5 million. This limitation includes the costs of the studies, preparation of plans and specifications, and construction.
3. The selected plan must be complete and fully effective, requiring no additional obligation by the Federal Government to make the project operational. If the Federal portion of project costs exceeds the Federal limitation, the local sponsor must pay the difference.
4. Any recommended project must be justified under established Federal planning criteria.
5. The recommended project must be acceptable and supported by a local sponsor.

## ALTERNATIVE PLAN ANALYSIS

### Formulation Process

During plan formulation, alternative plans are identified to satisfy specific study objectives. It is an iterative process in which plans are identified and evaluated in greater detail until a plan that maximizes net national economic development benefits is identified. That plan is considered the National Economic Development (NED) plan and is the preferred plan for the study.

The objective of plan formulation is to determine the type and scope of a plan of improvement for reducing flood damages. In the first part of the process, the types of alternatives that are economically feasible in reducing the damages are identified. In the second part of the process, the most economical plan of the type selected is determined.

Each of the alternative plans is evaluated in terms of economic efficiency, social and environmental acceptability, completeness, and effectiveness.

Economic efficiency is the extent to which an alternative plan is the most cost-effective means of solving the flood problem and realizing opportunities consistent with protecting the Nation's environment. Economic efficiency is determined by the benefit-to-cost ratio (B/C). If the B/C ratio exceeds unity, the alternative is economically justified.

Acceptability is the workability of the alternative plan with respect to acceptance by the city of Wichita Falls and the public, and the compatibility of the plan with existing environmental laws, regulations, and public policies.

Completeness is the extent to which an alternative plan provides and accounts for all necessary investments or other actions to ensure realization of the planned effects.

Effectiveness is the extent to which an alternative plan solves specific problems and achieves specific opportunities. Each alternative plan includes measures, as appropriate, to mitigate effects on fish and wildlife resources.

The total annual costs of the alternative plans considered in the formulation process are determined using the specified Federal discount rate (8-1/2%). The project's first costs are amortized over the designated period of analysis (50 years). Interest during construction and annual operation, maintenance, and major replacement costs are included in the analysis.

## **Preliminary Plans**

In the alternatives analysis for Plum Creek, both structural and nonstructural plans were identified. A flood warning system was considered, but was determined to be impractical due to the nature of the stream. Flooding along Plum Creek is characterized as flashy with a high peak discharge, but of relatively short duration. Therefore, there is little time to warn residents to evacuate. Floodproofing was not considered practical because of the large number of structures in the floodplain.

A levee was one of the structural plans identified, but it was not considered practical because of the many roadway crossings, utility lines, and residences that are located along the channel. Only two plans, a channel improvement plan and an upstream dry detention dam, were considered in detail. Both plans were considered during the reconnaissance phase of study.

## **PLANS CONSIDERED IN DETAIL**

### **Channel Alternative**

A channel alternative was one of the structural plans considered in detail. During preliminary investigations, it was determined that a channel plan requiring no modification to existing bridges would not provide measurable flood reduction benefits. Therefore, the channel plan considered in detail consisted of widening the existing concrete-lined channel approximately 10 feet between the North Side Irrigation Canal and the Old Iowa Park Highway (Figure 3). This segment was part of the 8 miles of channel improvements recommended in the 1963 local flood protection study conducted by the Tulsa District. At that time, the city was unable to cost share in the recommended plan, but officially adopted the approved detailed project report as a master drainage plan for the Plum Creek watershed. Because of limited financing in the 1963 bond program, the city requested that the Corps of Engineers study phased implementation of the recommended plan. Even with phased implementation, the city was not able to continue the project into construction. In the early 1970s, the city was able to construct some of the channel improvements without Federal funding.

In the current analysis, the bottom width of the existing concrete-lined channel would be widened about 10 feet on one side only, and the new side slope would be 1 vertical on 3 horizontal. This would allow alignment of the new channel while minimizing the impact on existing residences located adjacent to the channel on both sides. In addition, various utilities are located underground near the channel banks. The channel plan would require that the box culverts at Nunn Street and Cortez Drive be replaced. The existing culverts are three-celled, reinforced concrete boxes with each cell 6 foot by 6 foot. These structures would cause an

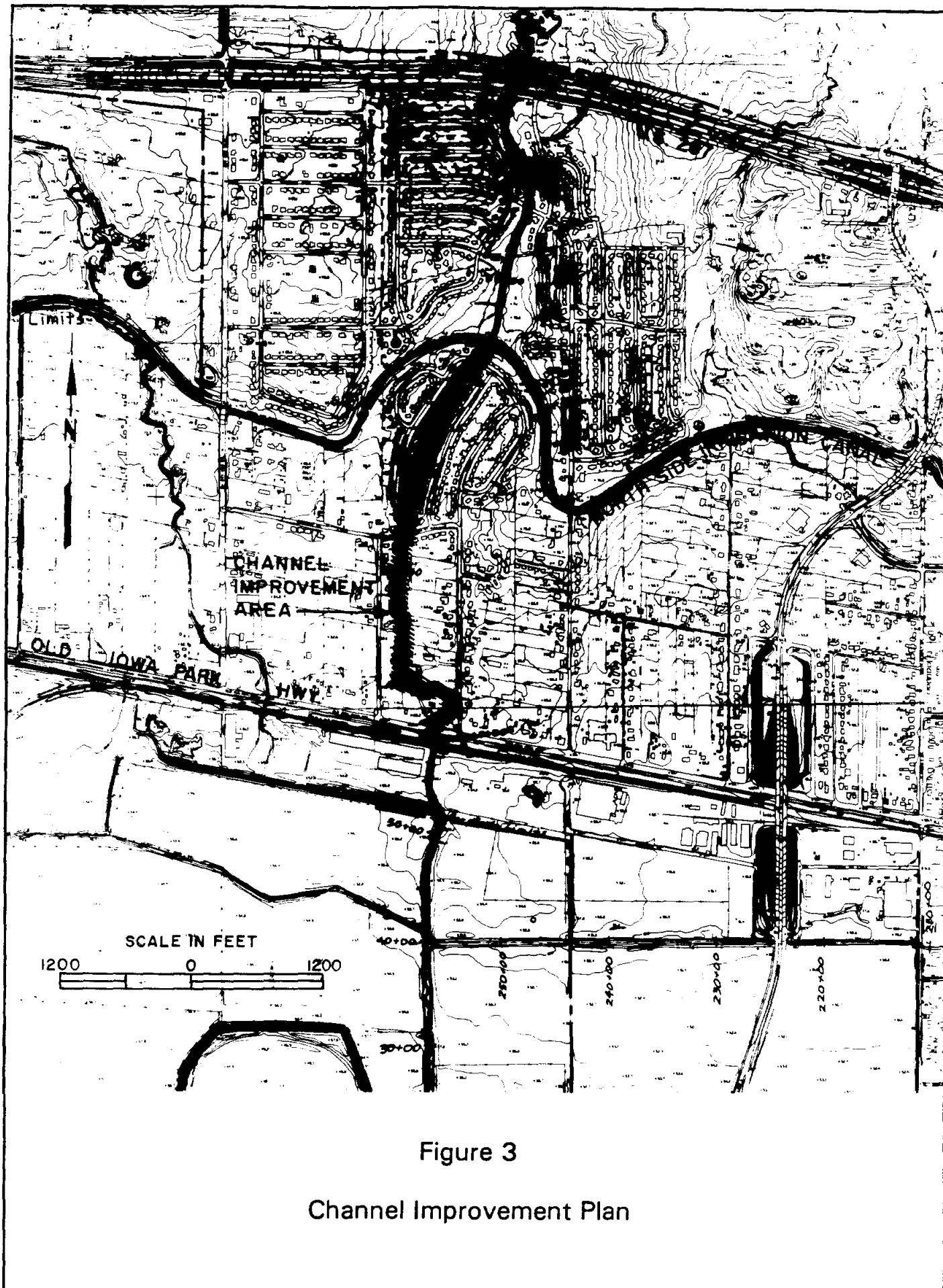

Figure 3

Channel Improvement Plan

impediment to flow if left unimproved. The channel reach under consideration is about 4,300 feet long.

Starting at the North Side Irrigation Canal and extending about 1,500 feet downstream, the modified channel provides flood protection from floods between the 25- and 50-year event. For the next 2,000 feet, the level of protection varies from the 10- to 50-year event, and in the lower 780 feet near Old Iowa Park Highway where development is sparse, the level of protection varies between the 5- and the 10-year event.

Appendix 2 discusses in detail the methodology of benefits calculation. Flood damage reduction benefits were estimated by evaluating damages with and without the flood control project under existing hydrologic conditions in the basin. Average annual flood losses remaining with the project were deducted from existing condition flood losses to derive average annual flood damage reduction benefits. The total average annual benefits for the channel plan were estimated to be \$174,500 (Table 1). Benefits attributed to a reduction in emergency costs and a reduction in damages to utilities are included in the total benefits.

---

TABLE 1  
SUMMARY OF FLOOD CONTROL BENEFITS  
CHANNEL PLAN  
(March 1992 prices)

---

Benefits Category	Benefits (\$)
Inundation	156,400
Emergency	1,700
Utilities	<u>16,400</u>
Total Annual Benefits	174,500

---

Benefits of \$174,500 would marginally support a project with total costs of about \$2 million. Construction costs (excluding relocations of utilities, bridge replacements, real estate acquisitions, or interest during construction) were estimated to be \$1.9 million (August 1991 prices). Since the additional costs of the channel plan were estimated to exceed \$100,000 (the amount remaining to yield at least a benefit-to-cost ratio of 1), it was determined that the channel plan would not be economically justified, and it was not considered further.

## **Detention Alternative**

An upstream dry detention alternative was also studied in detail. The dam would be located on Plum Creek in the upper watershed. The Plum Creek area is located north and west of the city limits and just northwest of the intersection of Interstate 44 and U.S. Highway 287. The location of the dam was identified by visual observation of the physical and geographical features within the watershed, such as the manmade barriers provided by the interstate highway on the east, U.S. Highway 287 on the south, and the urban development in the lower portion of the watershed, all of which restrict placement of a dam and spillway. Other constraints were a maximum pool elevation that would provide the most flood control storage and not allow the Probable Maximum Flood (PMF) to inundate the Central Freeway on the east side of detention site or existing structures on the west side of the detention site. Three feet of freeboard was added to protect against wind and wave runup. A 100-year sediment pool was designed for sediment storage, although the degree of protection offered would decrease after the 50-year project life.

The earthen dam would have an uncontrolled spillway and outlet works. The outlet works would not exceed channel capacity during low flow and would drain the flood pool in 7 to 10 days.

Alternative reservoir sizes, with tops of dam at elevations 1014, 1015, and 1016, were considered. The corresponding maximum pool elevations would be 3 feet less to provide freeboard. Those pool elevations would provide the most flood control storage without inundating the interstate highway. Each alternative utilized the same dam axis and location. Several spillway sizes were analyzed for each of the established maximum pool elevations. The detention structure was sized by establishing the maximum pool elevation and then developing a family of spillway sizes such that when the Probable Maximum Flood (PMF) was routed through the detention site on top of a full flood pool with an inoperative outlet works, the established maximum pool was not exceeded.

A preliminary determination of the annual costs and benefits of these alternative reservoirs was made using April 1991 prices. A discussion of the determination of preliminary benefits is included in Appendix 2. The net benefits were plotted versus frequency of protection (Figure 4). The National Economic Development (NED) plan is the plan with the highest net benefits (Table 2).

## **Selected Plan**

Maximum excess benefits occurred at the 50-year frequency of protection at top of dam elevation 1014 (Table 2). This plan was considered the NED plan and is discussed in greater detail in the remainder of the report.

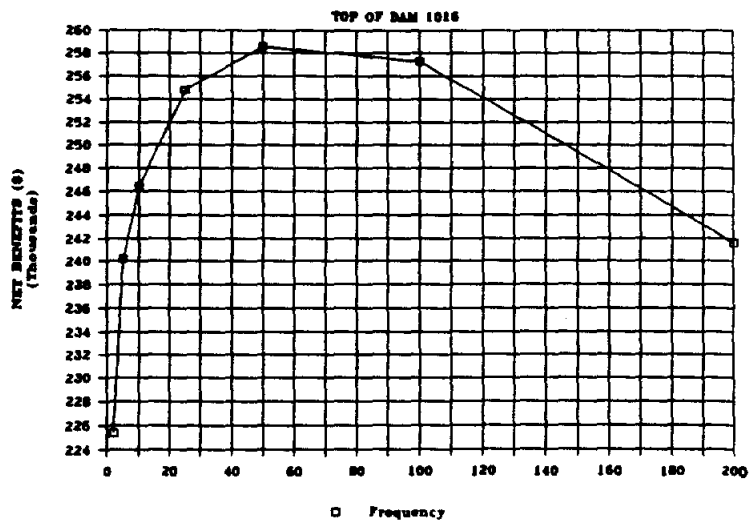
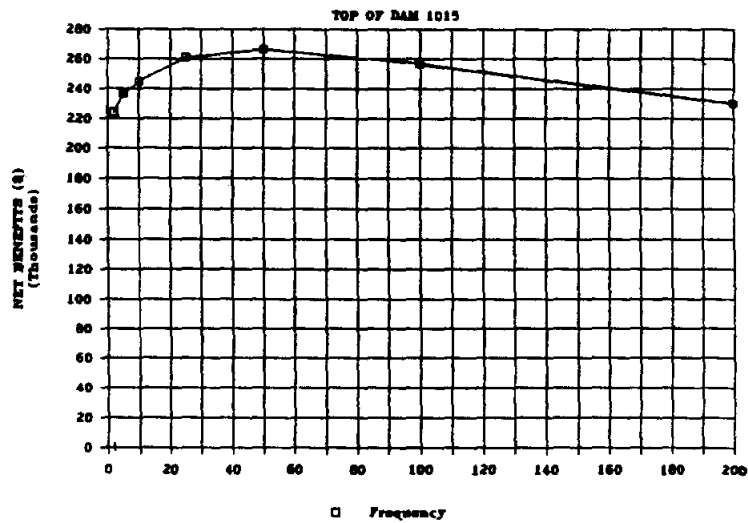
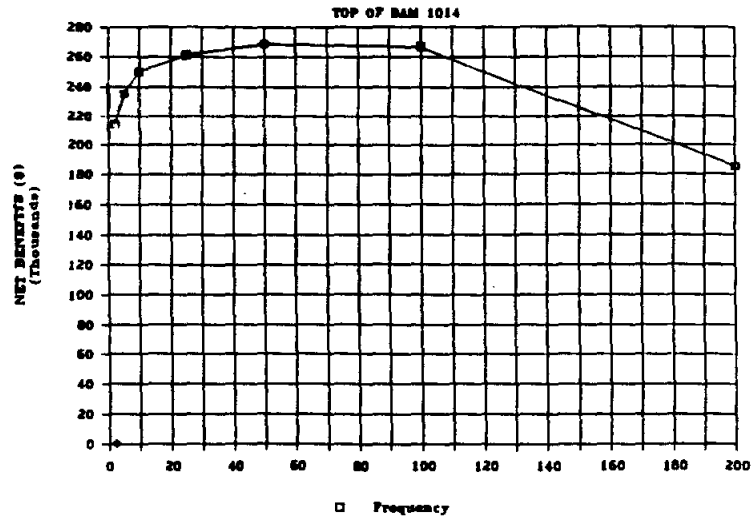

**Figure 4**  
**Preliminary Net Benefits Vs. Frequency**

TABLE 2

PRELIMINARY NET BENEFITS  
(April 1991 Prices)

Top of Dam Elevation	Frequency (yrs)	Annual Costs (\$)	Annual Benefits (\$)	Net Benefits (\$)
1014				
	2	138,100	352,600	214,500
	5	138,200	373,300	235,100
	10	139,600	389,900	250,300
	25	143,100	404,700	261,600
	50	148,100	416,800	268,700*
	100	158,800	425,400	266,600
	200	248,400	433,800	185,400
1015				
	2	144,700	368,900	224,200
	5	144,800	381,200	236,400
	10	145,500	390,300	244,800
	25	147,200	408,300	261,100
	50	151,000	417,400	266,400
	100	171,300	428,300	257,000
	200	203,100	434,000	230,900
1016				
	2	157,100	382,500	225,400
	5	156,600	396,800	240,200
	10	157,500	403,900	246,400
	25	159,000	413,800	254,800
	50	161,400	419,800	258,400
	100	174,400	431,700	257,300
	200	192,400	434,100	241,700

\* Denotes NED Plan



## DESCRIPTION OF SELECTED PLAN

### GENERAL DESIGN DATA

The technical data prepared for this study are contained in Appendices 1 through 6, and include the hydrologic and hydraulic analyses, economic and social analyses, real estate report, geotechnical investigations, design and detailed cost estimates, and the Coordination Act Report from the U.S. Fish and Wildlife Service.

The plan with the highest net benefit was the detention plan (Figure 5) with top of dam at elevation 1014 National Geodetic Vertical Datum (NGVD) (with 3 feet of freeboard), a spillway crest elevation at 1002 NGVD, and a spillway width of 165 feet. Pertinent data for this plan are presented in Table 3. Project design, with detailed design drawings, is included in Appendix 5.

The selected plan has a top of flood control pool at elevation 1002 NGVD. The flood control pool encompasses 148 acres. About 200 acre-feet of borrow excavation for the embankment fill would be taken from the area of inactive pool for sediment accumulation.

The outlet works is a 30-inch-diameter, reinforced concrete pipe. Flow will discharge from the pipe onto a concrete slopewall apron before being released into the outlet channel. Riprap will be placed downstream of the apron to protect the natural channel from scour at the toe of the apron. The entrance to the outlet pipe will also consist of a slopewall apron structure. The entrance to the pipe will be protected from debris with a gated trashrack placed over the pipe entrance.

The emergency spillway would be cut at a location on the eastern side of the detention pond embankment. The emergency spillway channel would have a trapezoidal shape with a bottom width of 165 feet and side slopes of 1 vertical to 3 horizontal. It would be grass lined except for a concrete sill at the crest.



Figure 5  
Recommended Plan  
Upstream Dry Detention

TABLE 3

PERTINENT DATA  
UPSTREAM DRY DETENTION

PROJECT LOCATION      The project area is located northwest of the intersection of Interstate 44 and U.S. Highway 287 in Wichita Falls, Texas.

TYPE OF PROJECT      The project would be an earthfill dam with an uncontrolled spillway, uncontrolled outlet works, and supporting facilities.

DRAINAGE AREA

Upstream from the damsite	4.1 square miles
Downstream from the damsite	3.4 square miles
Total drainage area (mainstem)	7.5 square miles

DAM

Top of dam elevation	1014 NGVD
Top width	15 feet
Side slopes	1 Vertical to 3 Horizontal
Length	3,074 feet
Maximum height above streambed	28.8 feet
Average height above valley floor	25 feet
Uncontrolled outlet	30-inch-diameter RCP
Emergency spillway	
Elevation	1002 NGVD
Bottom Width	165 feet

LAND REQUIREMENTS

Embankment, spillway, and drainage channel (in fee)	52.4 acres
Mitigation (in fee)	24 acres
Flowage and borrow easement for detention and borrow area	51.5 acres
Flowage easement for detention	254.7 acres
Flowage easement below spillway	7.8 acres
Access road easement	1.3 acres
16 ownerships, but no displacement	

## Mitigation Plan

The Plum Creek Basin is situated in the mesquite/buffalo grass section of the prairie brushland ecoregion (Bailey 1980). Due to urban development in the lower part of the basin, the best remaining wildlife habitat would be located along riparian zones and mesquite grasslands in the upper segment of the creek.

The U.S. Fish and Wildlife Service's Mitigation Policy (Federal Register 46 [15]: 7644-7663) provides guidance for formulation of measures to offset project impacts on habitat value. Species used to evaluate the riparian habitat of Plum Creek included migrating and nesting songbirds and small mammals, such as fox squirrels and raccoons. It was determined that the riparian habitat of Plum Creek is of medium value for the evaluation species and that riparian habitat is relatively abundant on a national basis. The Service's mitigation goal for riparian habitat is no net loss of habitat value while minimizing loss of in-kind habitat value. Mesquite grasslands in the site possess medium to low habitat value for evaluation species and are abundant within the project area. The mitigation goal for mesquite grasslands is to minimize loss of habitat value.

The most direct impacts on wildlife resources would occur from loss of habitat due to construction of the detention embankment, the borrow sites, and the access road. Approximately 4 acres of riparian timber and 19.5 acres of mesquite grasslands would be impacted. About 75 acres of mesquite grasslands would be impacted by borrow sites, and approximately 40 acres of riparian habitat along the creeks upstream of the embankment would be affected by flood control operations.

Construction of the detention embankment and access road will result in the loss of about 4 acres of riparian timber and 8 acres of mesquite grasslands. About 75 acres of unknown habitat will be affected at the borrow sites. The U.S. Fish and Wildlife Service is seeking compensation only for loss of riparian timber. Using the Habitat Evaluation Procedures, the Service determined that a 14.5-acre mitigation area would be required (Appendix 6).

Several alternative mitigation plans were initially considered. A riparian zone located in the upper reaches of the detention pool was considered, but was dropped from further consideration because flood control operation of the detention structure would not allow development. Mitigation of riparian losses on other public lands near the project area was also considered, but no other public lands were found near the project area that could be developed for mitigation.

The preferable acquisition would be a continuous tract of existing riparian habitat. Such lands were found along the creek immediately below the dam. Consistent with guidelines contained in

Engineer Regulation 1105-2-100, dated 28 December 1990, Subject: Guidance for Conducting Civil Works Planning Studies, an incremental cost analysis was conducted for the proposed mitigation area (Appendix 6).

The recommended mitigation area is a 24-acre site downstream of the embankment that includes riparian habitat identified by the Service as desirable for preservation (Figure 6). The additional 10 acres of mesquite grassland are included since this tract would be inaccessible to the landowner and would become an uneconomic remnant. A detailed mitigation analysis is shown in Appendix 6 of this report.

#### **Section 404 Determination**

The Plum Creek Project qualifies for a Nation-wide Permit pursuant to Section 404 of the Clean Water Act. A copy of the permit is provided in Appendix 8.

#### **Real Estate Requirements**

Most of the land required for the detention site is pastureland. Approximately 306 acres of flowage easements would be required over lands up to elevation 1011 NGVD for the detention area. An additional flowage easement of about 7.8 acres will be needed downstream of the spillway for potential discharges. A borrow easement estate would be required on 51.5 acres of the detention area where excavated material will be obtained for construction of the embankment. About 200 acre-feet of borrow excavation for the embankment fill would be taken from the area of inactive pool for sediment accumulation. The project will require the purchase of 76.4 acres in fee. The embankment, spillway, and drainage channel would require 52.4 acres purchased in fee, and the mitigation area would require 24 acres. A perpetual road easement of 1.3 acres would be needed for an access road to connect the project to public roads. The access road will extend from the west end of the damsite area to the southeast corner of the intersection of Tank Farm Road and City View Lane on the west side of the project.

The real estate needed for the project affects 16 ownerships. No residences, farms, or businesses would be displaced by the project.

#### **Relocations Requirements**

Utility relocations required in connection with the recommended plan would be the raising of five power poles about 10 feet on a 12.5-kilovolt (kV) line that crosses the embankment. A 550-foot segment of buried electrical cable (12.5-kV) would need to be relocated outside the toe of the embankment area. These relocations are described in Appendix 5.

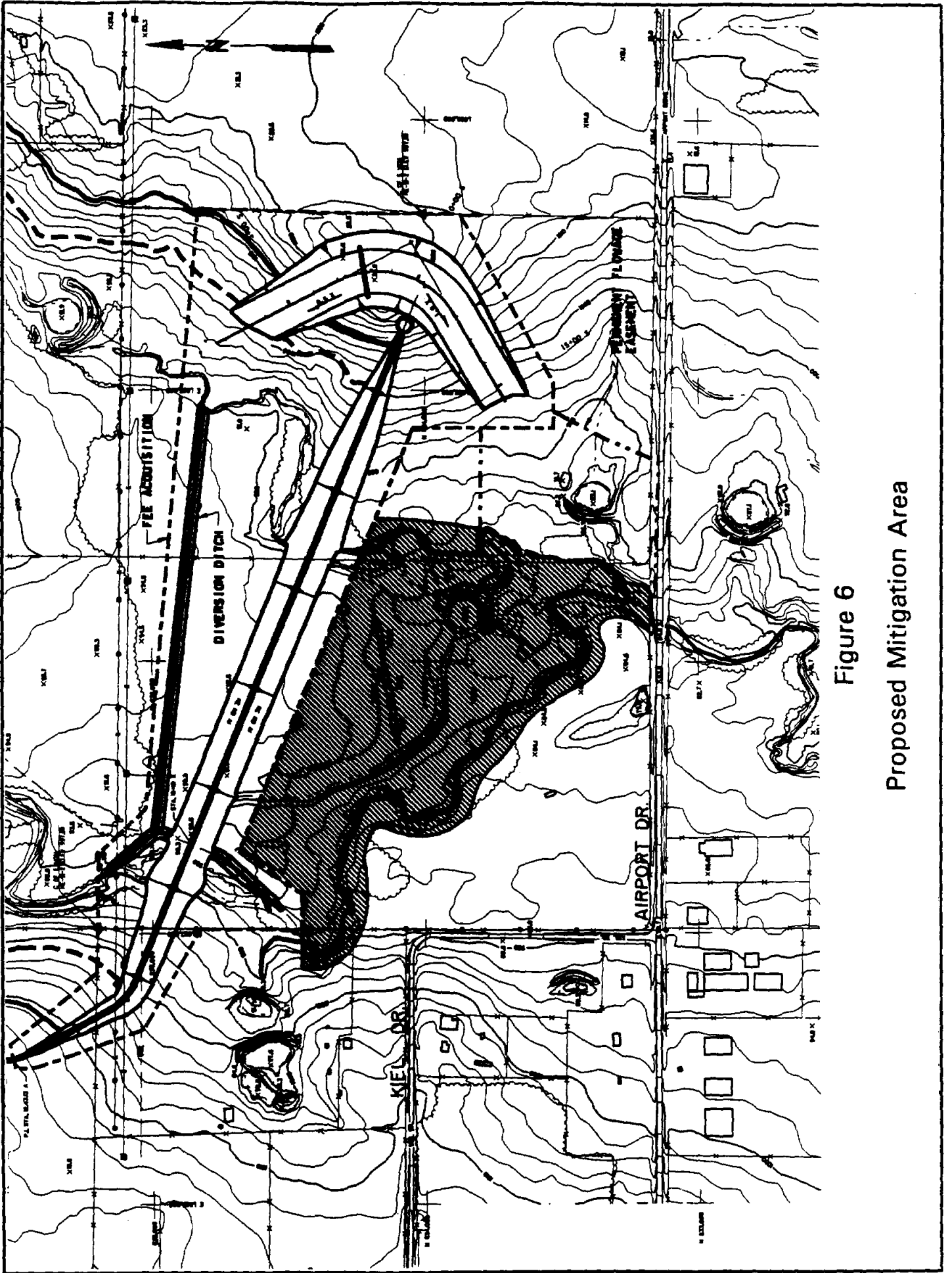

Figure 6  
Proposed Mitigation Area

## COSTS OF SELECTED PLAN

Project costs were developed based on March 1992 price levels. The detailed cost estimate and certification of costs are included in Appendix 5. A summary of the project costs is listed in Table 4.

TABLE 4

### SUMMARY OF ESTIMATED COSTS (March 1992 Prices)

Cost Acct.	Item	Amount (\$)
01	Lands and Damages	322,200
02	Utility Relocations	37,550
04	Dams	1,651,740
06	Fish and Wildlife Facilities	18,700
08	Roads, Railroads, and Bridges	14,500
30	Planning, Engineering, & Design	158,750
	HTW Survey	6,250
31	Construction Management	196,250
	Total Costs	2,405,940

## OPERATION AND MAINTENANCE OF SELECTED PLAN

The embankment, spillway, and areas disturbed by construction would be reseeded with native grasses and wild flowers. The embankment area would be mowed about once a year. Operation and maintenance (O&M) of the completed project would be the sole responsibility of the local sponsor. O&M requirements and guidance will be stated in the O&M manual which will be furnished by the Government to the local sponsor as the transfer of responsibility is made for the completed project. The general policy of the Corps of Engineers will be to inspect the project annually, as requested by the local sponsor, and when deemed necessary by the District Commander.

The project would be operated in strict accordance with the project O&M manual, both during normal times and in times of high water. This would include accomplishing needed repairs, including, but not limited to, maintenance and repair of roads, fences, turf, drainage structures, embankments, and other project grounds.

The average annual O&M costs for the detention area are estimated to be \$7,500/year, with an additional \$1,500/year for the mitigation area. No major replacements are anticipated for the detention area over the 50-year project life.

## **PLAN ACCOMPLISHMENTS**

The detention pond begins spilling a minimal amount at the 25-year frequency; however, the channel capacity downstream is not exceeded in most locations until the 50-year event or greater. The proposed plan would enhance the overall quality of life for residents in the problem area by eliminating the threat of flooding from more frequently occurring events. The detention site would remain in pastureland usage providing a visual open space to the surrounding urban area.

## **BENEFIT ANALYSIS OF THE SELECTED PLAN**

The economic studies are discussed in detail in Appendix 2. The benefit analysis examined the area along Plum Creek that is within the Standard Project Flood (SPF) floodplain. The area was divided into ten economic reaches. Elevation-damage curves were developed for each reach and damage category by structure and contents. The structural and content categories included damages to residential, commercial, industrial, public, and semi-public properties. These damages were evaluated using the Hydrologic Engineering Center's (HEC) Structure Inventory for Damage (SID) Analysis computer program. In addition, flood damages were developed for utilities and emergency cost related expenses, based on the number of structures damaged at various flood frequencies. The aggregate elevation-damage curves were computed by one-foot increments of flood depth, starting at an elevation one foot below the lowest first floor elevation in each reach. The reach elevation-damage curves were combined with HEC-2 water surface elevations for existing and with-project conditions utilizing the HEC Expected Annual Damage (EAD) computer program in order to calculate expected annual damages with and without the project.

Several categories of flood control benefits occur from implementation of a flood control plan. Flood damage reduction benefits for each upstream detention plan were estimated by comparing the expected annual flood damages with and without the project. During the May 1982 flood in Wichita Falls, it was estimated that \$2.2 million were spent providing emergency services to flood victims. That flood was used as the basis for calculating emergency costs. In 1992 price levels, the NED plan would reduce emergency costs by \$43,900 annually. Data from post-flood studies conducted by the Corps of Engineers in June 1979 (outside the Wichita Falls area) indicated that flooding also caused damages to utility and transmission lines. In 1979, damages to utilities averaged \$77/structure. That cost, updated to 1992 prices, yielded an estimated \$123/structure.

A summary of the annual flood control benefits for the detention plan is shown in Table 5. Intangible benefits, such as reduced hazards to health and life, exist, but have not been included in this evaluation.



TABLE 5  
SUMMARY OF ANNUAL FLOOD CONTROL BENEFITS  
(March 1992 prices)

Benefits Category	Benefits (\$)
Inundation	450,100
Emergency	43,900
Utilities	4,500
<b>Total Annual Benefits</b>	<b>498,500</b>

**Benefit-to-Cost Ratio**

The average annual costs of the selected plan are compared to the average annual benefits to provide a benefit-to-cost ratio. The benefit-to-cost ratio must be at least unity to allow Federal participation in a project.

The proposed detention plan has an estimated total construction cost (including lands and relocations) of \$2.4 million. The total investment needed, however, would also include the interest that would accrue during the period of construction, which is estimated to be one year. The average annual costs of the project are determined by amortizing the total investment cost and adding to that sum, the annual operation and maintenance cost of the flood control project (Table 6).

The detention project would have an average annual cost of \$214,260 when amortized over a 50-year economic period at 8-1/2% interest. Annual operation and maintenance costs are estimated at \$9,000 for a total average annual cost of \$223,260. Comparing the project benefits (\$498,500) to the annual cost (\$223,260), yields a benefit-to-cost ratio of 2.2.

TABLE 6  
INVESTMENT AND ANNUAL CHARGES

Item	Costs (\$)
<u>Investment</u>	
Costs During Construction	1,881.0
Interest During Construction (1)	72.1
Lands and Relocations	360.0
Plans and Specifications	<u>165.0</u>
Total Gross Investment	2,478.1
<u>Annual Charges</u>	
Interest and Amortization (2)	214.3
Operation and Maintenance	<u>9.0</u>
Total Annual Charges	223.3
<hr/>	
(1) Construction period is estimated to be one year.	
(2) Amortized over a 50-year economic period at 8-1/2% interest.	

**SUMMARY OF ENVIRONMENTAL, ECONOMIC, AND OTHER SOCIAL EFFECTS**

Construction of the detention structure would have an impact on the mesquite grassland habitat and on the riparian habitat. Wildlife impacts can be avoided by not clearing the vegetation in the detention site. A mitigation plan was developed for those impacts that cannot be avoided.

A detailed account of the environmental setting and environmental impacts of the project are described in the Environmental Assessment which follows the main report. A mitigation plan, developed by staff of the U.S. Fish and Wildlife Service in cooperation with staff of the Tulsa District, Corps of Engineers, is part of the selected plan.

The economic effectiveness of the selected plan is determined by comparing average annual costs to average annual benefits. The average annual costs are estimated to be \$223,260, and include annual costs for O&M. The average annual benefits are estimated to be \$498,500, resulting in a benefit-to-cost ratio of 2.2. The project economics are summarized in Table 7.

TABLE 7  
SUMMARY OF PROJECT ECONOMICS  
SELECTED PLAN

Item	Amount (\$)
Project Cost	2,478,100
Annual Cost*	223,300
Annual Benefits	498,500
Annual Net Benefits	275,200
Benefit-to-Cost Ratio	2.2

\* This figure includes annual O&M costs of \$9,000.

Based on the historic socio-economic trends for the county, changes that may occur within the study area would be very gradual. The changes, if any, would probably be influenced by the two major employers, Sheppard Air Force Base and Midwestern State University. Despite slow economic growth, unemployment in the metropolitan statistical area remains low.

The proposed project will not displace any families, homes, or businesses. With the project in place, the potential for reduced flood damages could provide a more conducive environment for business development. Although not quantifiable, the reduced flood damages would enhance the health and safety of the residents within the study area. Local governments and community service agencies would not have to provide emergency services resulting from flood damages as frequently as without the project.

## **PLAN IMPLEMENTATION**

### **INSTITUTIONAL REQUIREMENTS**

A Financial Capability Analysis was conducted (Appendix 7) and it was determined from that analysis that the city of Wichita Falls is capable of financing the local share of the project. The city is willing to sponsor the project and understands its obligations as the local sponsor for the project. A Letter of Intent is included in Appendix 10.

### **DIVISION OF RESPONSIBILITIES**

#### **Local Sponsor**

The local sponsor must enter into a Local Cooperation Agreement (LCA) with the Federal Government stating that it will provide its cash share of the construction costs; that it agrees to operate and maintain the project; and that it will hold and save the United States free from damages due to the construction or operation and maintenance of the project, except for damages resulting from negligence.

The local sponsor must also acquire all the necessary lands, easements, and rights-of way and relocate any affected utilities prior to the start of construction. At the completion of the project, the local sponsor is responsible for operation and maintenance. The project would be operated and maintained in strict accordance with the Operation and Maintenance Manual.

#### **Federal**

Federal responsibilities for implementing the selected plan include funding the Government's share of developing plans and specifications and project construction. The Government prepares the plans and specifications and provides construction management. After construction is completed, the local sponsor assumes operation and maintenance. The Government prepares an Operation and Maintenance Manual to furnish to the local sponsor. The manual details Federal requirements for operation, maintenance, and inspection of the project.

### **PROJECT COST SHARING REQUIREMENTS**

In accordance with the Water Resources Development Act of 1986, the local sponsor would provide at least 25% of the total project cost. This share includes a minimum cash contribution of 5% of the total project cost at the start of construction. The local sponsor receives credit for the costs of lands, easements, rights-of-way, and utility relocations associated with the project. Since construction is not scheduled to begin until October 1995,

the project costs were inflated through the midpoint of construction (see Table 8).

TABLE 8  
PROJECT COSTS  
(Inflated through Construction)

Cost Acct.	Item	March 1992 (\$)	Inflation Amount (\$)	Costs 1996 (\$)
01	Land and Damages	322,200	9,100	331,300
02	Utility Relocations	37,550	1,370	38,920
04	Dams	1,651,740	202,900	1,854,640
06	Fish and Wildlife Facilities	18,700	2,290	20,990
08	Roads, Railroads, & Bridges	14,500	1,780	16,280
30	Planning, Engineering, & Design	158,750	10,580	169,330
	HTW Survey	6,250	300	6,550
31	Construction Management	196,250	53,240	249,490
	Total Costs	2,405,940	281,560	2,687,500

The cost distribution between the sponsor and the Federal Government for the proposed project, inflated through construction, is shown in Table 9.

TABLE 9  
PROJECT COST SHARING RESPONSIBILITIES  
(Inflated through Construction)

Item	Federal (\$)	Non-Federal (\$)	Total (\$)
Lands, Easements, Rights-of-Way, Relocations, Disposal (1)	--	370,200	370,200
Plans & Specifications (2) and Construction (3)	<u>2,015,625</u>	<u>301,675</u> (4)	<u>2,317,300</u>
Total	2,015,625	671,875	2,687,500

Note: Annual O&M is estimated to be \$9,000.

- (1) LERRDS inflated July 1994-June 1995.
- (2) Plans and specifications inflated May 1993-January 1994.
- (3) Construction inflated October 1995-October 1996.
- (4) Includes 5% cash (\$134,375) required at the start of construction.

**HAZARDOUS AND TOXIC WASTE SURVEY**

A cost-shared hazardous and toxic waste (HTW) survey will be conducted during the Plans and Specification phase to determine the potential for any HTW contamination at the project area. The local sponsor is responsible for the costs associated with any HTW cleanup that might be required. Local responsibility for hazardous substances is defined in Article XIX of the Local Cooperation Agreement for a Section 205 Single-Purpose Structural Flood Control Project.

**PROJECT SCHEDULE**

The following schedule was developed for completion of the project:

Final Approval of Detailed Project Report by Southwestern Division, Corps of Engineers	August 1992
Review and Approval at HQUSACE	April 1993
Completion of Plans and Specifications	January 1994
Review of P&S and Construction Approval	May 1994
Execute LCA	June 1994
Completion of Relocations and Property Acquisition	June 1995
Initiation of Construction	October 1995

**VIEWS OF LOCAL SPONSOR**

The city of Wichita Falls is supportive of the detention plan and has provided a Letter of Intent (Appendix 10) to continue as the local sponsor.

## **SUMMARY OF COORDINATION, PUBLIC VIEWS, AND COMMENTS**

### **COORDINATION WITH SPONSOR**

Monthly meetings were held with the Study Team Management, which included representatives from the city of Wichita Falls. In addition, the Executive Committee for the study included two members from the city. A public workshop on the project was held at Wichita Falls, Texas, on January, 16, 1992. The minutes of that meeting and other pertinent correspondence are contained in Appendix 9.

### **COORDINATION WITH OTHER AGENCIES AND PUBLIC ENTITIES**

The U.S. Fish and Wildlife Service was involved throughout the study process. A copy of its Coordination Act Report is included in Appendix 6. Other agencies were provided opportunities to comment during preparation and review of the Environmental Assessment included in this report.

## RECOMMENDATIONS

Having considered the environmental, social, and economic conditions and engineering feasibility, I recommend that the detention plan selected herein to reduce flooding along Plum Creek in Wichita Falls, Texas, be authorized for implementation as a Federal project with such modifications as in the discretion of the Commander, HQUSACE, may be advisable; at a total first cost presently estimated at \$2.4 million (March 1992 prices), of which a first cost to the United States is presently estimated at \$1.8 million, provided that, except as otherwise provided in these recommendations, the exact amount of non-Federal contributions under current cost sharing policy shall be determined by the Chief of Engineers prior to project implementation, in accordance with the following requirements to which the non-Federal interest must agree prior to implementation:

1. Subject to the non-Federal cost limit of 25% of the total project cost, provide without cost to the United States, in compliance with the Uniform Relocation Assistance and Real Property Acquisition Policies Act of 1970 (Public Law 91-646), all lands, easements, and rights-of-way necessary for implementation, maintenance, and operation of the project;

2. Subject to the non-Federal cost limit of 25% of the total project cost, bear the cost of all alterations and relocations of buildings, utilities, storm drains, roads, and other community services required for implementation of the project;

3. Hold and save the United States free from damages due to implementation and subsequent operation and maintenance of the project, except damages due to the fault or negligence of the United States or its contractors;

4. Maintain and operate the project, including mitigation features, after completion in accordance with regulations prescribed by the Secretary of the Army;

5. Provide a cash contribution of 5% of the total project cost;

6. Provide cash in excess of the Federal limitation;

7. Prevent encroachment that could interfere with the maintenance and operation of the flood control project;

8. At least annually, publicize and notify all interested parties that the project will not provide protection from the occurrence of storms greater than the project design flood; and



9. Adopt and enforce floodplain regulations and assure compatibility of future development that would ensure an unobstructed floodway.

OTIS WILLIAMS  
Colonel, Corps of Engineers  
District Engineer

## DISCLAIMER

The recommendations contained herein reflect the information available at this time and current Departmental policies governing formulation of individual projects. They do not reflect program and budgeting priorities inherent in the formulation of a national Civil Works construction program nor the perspective of higher review levels within the Executive Branch. Consequently, the recommendations may be modified before they are transmitted to the Congress as proposals for authorization and implementation funding. However, prior to transmittal to the Congress, the sponsor, the States, interested Federal agencies, and other parties will be advised of any modifications and will be afforded an opportunity to comment further.

**PLUM CREEK  
LOCAL FLOOD PROTECTION PROJECT  
WICHITA FALLS, TEXAS**

**ENVIRONMENTAL ASSESSMENT**

**U.S. Army Corps of Engineers  
Southwestern Division  
Tulsa District**

**June 1992**

**FINDING OF NO SIGNIFICANT IMPACT**

In accordance with the National Environmental Policy Act of 1969, including guidelines in 33 Code of Federal Regulations, Part 230, the Tulsa District has assessed the environmental impacts of the Plum Creek Flood Protection Project, Wichita County, Wichita Falls, Texas.

The attached Environmental Assessment indicates the impacts of the action would not significantly affect the natural or human environment; therefore, an environmental impact statement is not required.

\_\_\_\_\_

Date

Otis Williams  
Colonel, Corps of Engineers  
District Engineer

Atch  
Env Assess

## ENVIRONMENTAL ASSESSMENT

### PLUM CREEK FLOOD PROTECTION PROJECT WICHITA COUNTY, WICHITA FALLS, TEXAS

#### 1. Description of the Project.

The proposed plan is a detention structure with an earthen embankment about 3,100 feet long. The top of the dam is at elevation 1014, which provides 3 feet of freeboard. The maximum pool is at elevation 1011, while the top of the 100-year flood control pool is elevation 1002. The embankment would average about 25 feet tall and would cover approximately 17 acres. The inactive pool for sediment storage would cover about 68 acres. The top of the inactive pool is at elevation 991.8. The detention pond would hold water for about 7 to 10 days during high flood flows.

An emergency spillway would be cut in the left abutment of the embankment. The emergency spillway would safely pass the Probable Maximum Flood. The spillway channel would have a bottom width of 165 feet with side slopes of 3 horizontal to 1 vertical. The emergency spillway would have an uncontrolled 30-inch-diameter concrete outlet pipe to allow low flows to continue downstream. The outlet channel would be lined with 18-inch riprap for 50 feet downstream of the headwall apron.

#### 2. Project Setting.

The main branch of Plum Creek begins in east central Wichita County, Texas, about 2.5 miles west of Sheppard Air Force Base. The stream flows south for approximately 6 miles to its confluence with the Wichita River. The Plum Creek watershed is comprised of four major drainages, and all can be characterized as seasonally intermittent, low order streams. Collectively, Plum Creek and its tributaries drain about 17 square miles. The terrain of the watershed consists of gently rolling hills on uplands and narrow, nearly level floodplains along creeks and small drainageways. Elevations range from 930 to 1,085 feet above mean sea level. Soils in the study area are moderately deep and loamy with some gravelly and stony loams in upland areas and deep, loamy soils along the creeks.

Dominant land uses along the main branch of Plum Creek are agricultural and urban development. The upper reaches of the creek are dominated by mesquite grasslands with gravelly uplands, which are used for livestock grazing. The more level upland areas are cultivated and planted to winter wheat. Urban development is largely confined to the lower reaches of the creek, which was channelized in 1960. Presently, about 50% of the main branch is urbanized, and single-family housing has developed adjacent to the stream bank.

Wildlife populations in the Plum Creek watershed currently are limited by existing land use patterns and by the moderate carrying capacity of the habitat. Urbanization has resulted in continual loss and degradation of quality wildlife habitat. The project is situated in the mesquite/buffalo grass section of the prairie brushland ecoregion (Bailey 1980). Within developed portions of the watershed, bird species diversity is limited primarily to species that have adapted to urban environments, such as blue jays, mockingbirds, robins, cardinals, starlings, and house sparrows.

Due to urban development in the middle reaches of the Plum Creek watershed, the remaining wildlife habitat is located along riparian zones and mesquite grasslands in the upper reaches of the stream. This area currently supports a diversity of mammals and birds. The riparian areas serve as transportation corridors for many animals, they hinder bank caving, and they protect streams from sedimentation. The areas also have aesthetic value.

Mesquite grassland areas are characterized by scattered mesquite and wild plum thickets. The grass community is typified by sideoats grama, little bluestem, blue grama, and buffalo grass. The most productive upland terrestrial habitats generally occur in prairie-to-riparian transition zones where wildlife species can use food and cover provided by both cover types. These mesquite grassland areas provide good quality habitat for such species as white-tailed deer, eastern cottontail, and coyote. Nesting habitat for migratory and non-migratory birds, such as mourning dove, flycatchers, meadowlarks, field sparrows, bobwhite quail, and raptors, is also provided in mesquite grasslands. Acreages of mesquite grasslands far exceed those of riparian zones in the project area.

Riparian zones are characterized by overstory trees such as hackberry, American elm, black willow, and bumelia. The understory consists mainly of grasses, vines, and herbaceous plants. These narrow riparian zones are extremely valuable as protective cover for migrating wildlife and dispersing resident wildlife, and as nesting habitat for resident songbirds, such as warblers, orioles, chickadees, wrens, and sparrows. Small mammals, such as raccoons, fox squirrels, opossums, skunks, rats, and mice, are also associated with riparian zones along the watershed.

Riparian zones have ecological importance far beyond their relatively small acreage. They typically have a greater quantity and diversity of vegetation than adjoining land. These areas remove sediments from flood waters as they move through the vegetation, thus enriching the riparian zone. They also act as sponges by holding water in stream banks, thereby raising the water table in the surrounding area and providing a more stable stream flow. During floods, healthy riparian areas dissipate the energy of flood waters and reduce flood peaks. Riparian areas provide food, water, shade, and cover for fish and wildlife, and forage for

both wild and domestic grazing animals. They also provide recreational opportunities and are aesthetically pleasing in an urban type environment.

Aquatic resources are minimal in the upper reaches of Plum Creek due to the intermittent presence of water and agricultural runoff. The fishery resources of this stream consist of adaptive fishes tolerant of these limited habitat conditions, such as mosquitofish, green sunfish, and red shiners. Due to the deleterious effects of bank disturbance, channel modification, and urban runoff, aquatic resources are severely limited in the lower reaches of the creek.

The project area is presently in private ownership and does not offer opportunities for public-oriented fish and wildlife recreation.

Federally-listed threatened or endangered species which might occur in the project area include the least tern (Sterna antillarum), whooping crane (Grus americana), and piping plover (Charadrius melodus). The whooping crane and piping plover migrate through Wichita County, and the least tern is known to nest in suitable habitat along the Red River.

The climate is of a continental nature with significant annual variations in temperature and precipitation. Average temperatures range from 43 degrees in January to 86 degrees in August. Rainfall, although erratic, averages about 28 inches per year. Most of the rainfall occurs in the form of showers during the period from late March to mid-November. Long dry periods are common.

Wichita Falls lies within an air quality region that is in attainment for all parameters that are monitored (i.e., particulates [PA], nitrogen oxides [NOx], sulfur oxides [SOx], and carbon monoxide [CO]). Ozone levels are not measured on a routine basis and, thus, are not reported.

### 3. Alternatives.

Preliminary Plans. During the reconnaissance phase of study, structural and nonstructural plans were identified. A plan to forewarn residents along the creek, using an early warning system, was considered but it was determined that such a system would be ineffectual due to the nature of the stream. Flooding along Plum Creek is characterized as flashy with a high peak discharge and of relatively short duration; therefore, there is little time to warn residents to evacuate. Floodproofing was not considered practical because of the large number of structures in the floodplain.

A levee was one of the structural plans identified, but it was not considered practical because of the many roadway crossings, utilities, and residences that are located along the channel. Only two plans, upstream detention and channel improvement, were considered further during the reconnaissance studies. Those two plans were considered in greater detail during the feasibility study.

Plans Considered in Detail. One plan considered in detail was widening of the existing concrete-lined channel between the North Side Irrigation Canal and the Old Iowa Park Highway. The existing channel would be widened about 10 feet on one side only, with the other side shaped to 3 on 1. The channel is lined along both sides with single-family housing. Construction costs, excluding relocations of utilities, real estate acquisitions, bridge replacements, and interest during construction, were estimated at \$1.9 million. Average annual benefits for this plan were estimated at \$174,500. Those benefits would support a project with costs of about \$2 million. Since the additional costs of the channel plan would easily exceed \$100,000 (the amount remaining to yield at least a benefit-to-cost ratio of 1), it was determined that the channel plan would not be economically justified and it was dropped from further consideration.

#### 4. Benefit Analysis.

The economic studies are discussed in detail in Appendix 2. The benefits analysis examined the area along Plum Creek that is within the Standard Project Flood (SPF) floodplain. The area was divided into ten economic reaches. Elevation-damage curves were developed for each reach and damage category by structure and contents. The structural and content categories included damages to residential, commercial, industrial, public, and semi-public properties. These damages are evaluated by using the Hydrologic Engineering Center's (HEC) Structure Inventory for Damage Analysis (SID) computer program. In addition, flood damages were developed for utilities and emergency cost-related expenses, based on the number of structures damaged at various flood frequencies. The aggregate elevation-damage curves were computed by 1-foot increments of flood depth, starting at an elevation 1 foot below the lowest flood first floor elevation in each reach. The reach elevation-damage curves were combined with HEC-2 water surface elevations for existing and with-project conditions utilizing the HEC Expected Annual Damage (EAD) computer program in order to calculate expected annual damages without and with the project.

Several categories of flood control benefits occur from the implementation of a flood control plan. Flood damage reduction benefits for each upstream detention plan were estimated by comparing the expected annual flood damages with and without the project. During the May 1982 flood in Wichita Falls, it was estimated the \$2.2 million was spent providing emergency services



to flood victims. That flood was used as the basis for calculating emergency costs. The estimated value of emergency costs for the households flooded, updated to 1992 prices, was \$43,900. Data from post-flood studies conducted by the Corps of Engineers in June 1979 indicated that flooding also caused damages to utilities and to transmission lines. In 1979, damages to utilities averaged \$77/structure. This cost, updated to 1992 prices, yielded an estimated \$123/structure.

A summary of the flood control benefits for the detention plan is shown in Table 1. Intangible benefits such as reduced hazards to health and life exist, but have not been included in this evaluation.

TABLE 1  
SUMMARY OF FLOOD CONTROL BENEFITS  
(March 1992 Prices)

Benefit Category	Benefits (\$)
Flood Damages Reduced	450,100
Reduced Emergency Costs	43,900
Damages to Utilities	<u>4,500</u>
Total	498,500

The average annual costs of the selected plan are compared to the average annual benefits to provide a benefit-to-cost ratio. The benefit-to-cost ratio must be at least unity to allow Federal participation in a project.

The proposed detention plan has an estimated total construction cost (including lands and relocations) of \$2.4 million. The total investment needed, however, would also include the interest that would accrue during the period of construction, which is estimated to be one year. The average annual costs of the project are determined by amortizing the total investment cost and adding to that sum the annual operation and maintenance cost of the project.

The detention project would have an average annual cost of \$214,260 when amortized over a 50-year economic period at 8-1/2% interest. Annual operation and maintenance costs are estimated at \$9,000 for a total average annual cost of \$223,260. Comparing the project benefits (\$498,500) to the annual cost (\$223,260) yields a benefit-to-cost ratio of 2.2. The project economics are summarized in Table 2.

---

TABLE 2  
SUMMARY OF PROJECT ECONOMICS  
(March 1992 Prices)

---

Item	Amount (\$)
Project Cost	2,406,000
Annual Cost*	223,260
Annual Benefits	498,500
Annual Net Benefits	275,200
Benefit-to-Cost Ratio	2.2

---

\* This figure includes annual O&M costs.

---

5. Significant Resources.

The project area is composed of two major habitat types, riparian and mesquite grassland. The riparian zone contains some small blocks of riparian timber. It was determined that the riparian habitat of Plum Creek is of medium value for the evaluation species and is relatively abundant on a national basis. The mitigation goal for riparian habitat was no net loss of habitat value while minimizing loss of in-kind habitat value.

The mesquite grassland complex is of low to medium habitat value for the evaluation species and is abundant on a regional basis. The mitigation goal or objective for this habitat type is to minimize loss of habitat values.

6. Impacts of the Proposed Project.

The most direct impacts on wildlife resources would occur from loss of habitat due to construction of the detention embankment, borrow sites, and access road. Habitat losses resulting from construction of the project are shown in Table 3. Approximately 4 acres of riparian habitat and 20 acres of mesquite grasslands would be impacted by the detention embankment and access road. Approximately 75 acres of mesquite grassland habitat would be directly impacted by borrow sites.

TABLE 3

IMPACTS ON WILDLIFE RESOURCES  
BY THE PROPOSED PROJECT

Land Requirements (acres)	Habitat Types (acres)	Impacted (acres)
	Mesquite Grassland	Riparian
Spillway/Embankment /Drainage Channel ( 52)	19	4
Access Road (1.3)	0.5	
Borrow Areas ( 52)	75	
Detention Pond (263)	290	40*

\* Denotes reduced habitat value over 50-year life of the project due to frequency of inundation of floodwater.

An additional 40 acres of riparian habitat within the detention site would be reduced in value as a result of repeated flooding for periods of 7 to 10 days. This is especially true for the areas within the 2-year flood pool of the project. Although the duration of flooding is not especially high for the rest of the detention basin, flooding could influence species composition and diversity of the overstory, understory, and ground cover over the 50-year life of the project. It is probable that with time more flood tolerant species, such as willow and cattails, will increase at the expense of less flood tolerant species, such as elm and hackberry.

7. Recommended Mitigation Measures.

Mitigation planning objectives for the project include the following measures:

- a. Minimize adverse impacts on stream riparian zones and riparian timber by avoiding them and by siting borrow areas at least 100 feet from the edges of the stream;
- b. Where possible, leave borrow areas so that they will contain water and benefit waterfowl;
- c. To the extent possible, locate borrow areas and access roads needed to construct and maintain the detention embankment in mesquite grasslands, away from riparian areas;
- d. Limit clearing in the detention pond to only the area needed to build the embankment; leave the remainder of the detention pond uncleared;

e. Reseed disturbed areas and the embankment to native grass species; and

f. To ensure no net loss of habitat value for riparian timber, establish a mitigation area downstream of the project.

An analysis of the U.S. Fish and Wildlife Service's mitigation recommendations and the District's recommended incremental mitigation plan is shown in Appendix 6.

#### 8. Environmental Evaluation.

The environmental statutes and other environmental requirements shown in Table 4 were reviewed to determine needed or appropriate interactions with State or Federal agencies having administrative responsibilities. The project, as planned, is in compliance with all the requirements of the noted statutes and executive orders.

---

TABLE 4

ENVIRONMENTAL STATUTES  
AND OTHER ENVIRONMENTAL REQUIREMENTS

---

#### Federal Statutes

Archeological and Historic Preservation Act, as amended, 16 U.S.C. 469, et seq.

Clean Air Act, as amended, 42 U.S.C. 1857h-7, et seq.

Clean Water Act, as amended (Federal Water Pollution Control Act), 33 U.S.C. 1251, et seq.

Endangered Species Act, as amended, 15 U.S.C. 1531, et seq.

Fish and Wildlife Coordination Act, as amended, 16 U.S.C. 661, et seq.

National Environmental Policy Act, as amended, 42 U.S.C. 4321, et seq.

Wild and Scenic Rivers Act, as amended, 16 U.S.C. 1271, et seq.

Farmland Protection Policy Act, 7 U.S.C. 4201, et seq.

#### Executive Orders, Memoranda, Etc.

Floodplain Management (E.O. 11988)

Protection of Wetlands (E.O. 11990)

---

#### 9. Summary of Environmental Compliance.

a. The proposed project was surveyed by a Corps of Engineers archeologist on December 23, 1988. Most of the project area was in pasture and weedy growth. Small portions of the uplands were

planted in winter wheat. These same upland locations contained a Pleistocene gravel deposit comprised of nappable chert and quartzite cobbles. The gravel could have been utilized by prehistoric man for the making of stone tools; however, no evidence of such activity was located. The bottomland appeared to be highly eroded and disturbed from previous land use. No archeological/cultural resources were located. The proposed project, as planned, should not affect any cultural resources.

This assessment will be furnished to the Texas Historical Preservation Office for comment.

b. There are no apparent conflicts with the Clean Air Act; however, this assessment will be furnished to the Environmental Protection Agency for comment.

c. The U.S. Fish and Wildlife Service (USFWS) determined the least tern (*Sterna antillarum*), whooping crane (*Grus americana*), and piping plover (*Charadrius melodus*) could possibly occur in the Plum Creek watershed. However, in their Coordination Act Report dated February 1992, they concluded the project will not impact these species.

d. The Tulsa District Regulatory Section has evaluated the proposed project in regard to Section 404 of the Clean Water Act and found the impoundment structure will be located above the headwaters of Plum Creek. The proposed work meets the criterion of the Nationwide Permit for Discharges into Certain Waters of the United States (Appendix 8).

e. Coordination will be accomplished with State and Federal fish and wildlife agencies in accordance with the Fish and Wildlife Coordination Act. A copy of their report, dated January 1992, is furnished in Appendix 6.

f. The project does not conflict with provisions of the Farmland Protection Policy Act. A farmland conversion impact rating was prepared for the project and coordinated with the Soil Conservation Service. No prime farmlands were found to be present in the area. A copy of the farmland conversion impact rating form is furnished in Appendix 9.

g. The work is in compliance with Executive Orders 11988 and 11990, Floodplain Management and Protection of Wetlands, respectively.

h. The city of Wichita Falls has researched the ownership of the project area. Prior use does not indicate any hazardous or toxic waste (HTW) areas. An HTW survey is scheduled during the Planning, Engineering, and Design (PED) phase.

10. Coordination.

The proposed action was furnished to the USFWS, the Texas Parks and Wildlife Department, the Environmental Protection Agency, the Department of Agriculture, the State Historic Preservation Officer, and the State Archeologist for review and comment.

**REFERENCES**

Bailey, R. G. 1978. Description of the ecoregions of the United States. U. S. Forest Service, Ogden, Utah. 77 p.

**PLUM CREEK  
LOCAL FLOOD PROTECTION PROJECT  
WICHITA FALLS, TEXAS**

**TECHNICAL APPENDICES**

**U.S. Army Corps of Engineers  
Southwestern Division  
Tulsa District**

**June 1992**

# APPENDIX 1 - HYDROLOGY AND HYDRAULICS



# APPENDIX 1

## HYDROLOGY AND HYDRAULICS

### TABLE OF CONTENTS

	<u>Page</u>
PLUM CREEK HYDROLOGY	
Basin Description . . . . .	1- 1
Storms of Record . . . . .	1- 1
Assessment of Available Data . . . . .	1- 1
Basin Mapping . . . . .	1- 1
Precipitation Stations . . . . .	1- 1
Rainfall-Runoff Procedures . . . . .	1- 4
Watershed Model . . . . .	1- 4
Unit Hydrograph Coefficients . . . . .	1- 4
Loss Rates . . . . .	1- 4
Routing Criteria . . . . .	1- 4
Flood Probability . . . . .	1- 7
Hypothetical Storms . . . . .	1- 7
Discharge-Frequency Data . . . . .	1-12
PLUM CREEK HYDRAULICS	
Assessment of Available Data . . . . .	1-14
Topographic Mapping . . . . .	1-14
Cross Sections . . . . .	1-14
Existing Water Surface Profile Computations . . . . .	1-14
Modified Conditions . . . . .	1-14
Channel Improvement Option . . . . .	1-14
Upstream Detention Option (Selected Option) . . . . .	1-15
Detention Structure Capacity . . . . .	1-15
Area-Capacity Data . . . . .	1-15
Sedimentation . . . . .	1-15
Maximum Pool Elevation . . . . .	1-15
Top of Dam Elevation . . . . .	1-19
Selected Detention Pond Alternative . . . . .	1-19
Modified Discharge-Frequency Data . . . . .	1-19
Modified Water Surface Profile Computations . . . . .	1-19
Outlet Works . . . . .	1-19
Inlet Apron . . . . .	1-19
Conduit . . . . .	1-25
Exit Stilling Basin . . . . .	1-25
Emergency Spillway . . . . .	1-25

TABLE OF CONTENTS (Continued)

Page

Tables

1- 1 Major Storms Occurring in the Wichita Falls Area (May 1940 to August 1989) . . . . .	1- 3
1- 2 Average Monthly Precipitation (Wichita Falls) . . . . .	1- 3
1- 3 Snyder's Unit Hydrograph Data (Plum Creek, Wichita Falls) . . . . .	1- 7
1- 4 Frequency Rainfall with Regional And Partial Duration Factors (24-Hour Rainfall in Inches) . . . . .	1- 8
1- 5 100-Year TP 40, 24-Hour Point Rainfall . . . . .	1- 9
1- 6 SPS 96-Hour Point Rainfall . . . . .	1-10
1- 7 PMS 96-Hour Point Rainfall . . . . .	1-11
1- 8 Plum Creek Peak Discharges . . . . .	1-12
1- 9 Elevation-Area-Capacity Data . . . . .	1-17
1-10 Pertinent Data for Upstream Dry Detention . . . . .	1-20
1-11 Spillway Discharge Velocities . . . . .	1-26

Figures

1- 1 Plum Creek Watershed Map . . . . .	1- 2
1- 2 HEC-1 Subarea Divisions Map . . . . .	1- 5
1- 3 Unit Hydrograph Coefficients . . . . .	1- 6
1- 4 Discharge-Frequency Curve - Existing Conditions at Detention Site . . . . .	1-13
1- 5 Proposed Dam Alignment . . . . .	1-16
1- 6 100-Year Flood Operational Hydrograph at Year 0 . . . . .	1-21
1- 7 100-Year Flood Operational Hydrograph at Year 0 . . . . .	1-22
1- 8 100-Year Flood Operational Hydrograph at Year 100 . . . . .	1-23
1- 9 100-Year Flood Operational Hydrograph at Year 100 . . . . .	1-24
1-10 Emergency Spillway Rating Curve . . . . .	1-27

Plates

1- 1 Water Surface Profiles for Existing Conditions . . . . .	1-28
1- 2 Water Surface Profiles for Existing Conditions . . . . .	1-29
1- 3 Water Surface Profiles for Modified Conditions . . . . .	1-30
1- 4 Water Surface Profiles for Modified Conditions . . . . .	1-31
1- 5 Flooded Area Outline 100-Year and SPF Events (Modified Conditions) . . . . .	1-32

## APPENDIX 1

### HYDROLOGY AND HYDRAULICS

#### PLUM CREEK HYDROLOGY

##### BASIN DESCRIPTION

Plum Creek is a left bank tributary of the Wichita River. It originates in the northwest portion of the city of Wichita Falls, Texas, and flows in a southerly direction to its confluence with the Wichita River. The basin has an uncontrolled drainage area of 7.5 square miles. The watershed is a rolling plain with some relief at the upper end. The soil is predominantly silty loam. The upper portion of the watershed is undeveloped agricultural land with mesquite brush and native grass cover. The middle portion, approximately 13% of the basin area, is a highly-developed residential area with a limited amount of commercial development along the southern fringe. Both developed and undeveloped agricultural land comprise the lower portion of the watershed. The basin has an average slope of 18 feet per mile. Figure 1-1 shows the general location of the study area.

##### STORMS OF RECORD

There are no stream gaging stations in the Plum Creek basin; therefore, historical information about specific basin flooding is limited. Data from the one official hourly recording precipitation gage in the Wichita Falls area does provide some information about storms that have occurred in the area. Table 1-1 presents a summary of major storms which have been recorded at the Wichita Falls precipitation gage from May 1940 to August 1989. In contrast, Table 1-2 is a summary of the monthly average precipitation at the gage, which is representative of the Plum Creek basin. The Wichita Falls area has an average yearly precipitation of 28 inches.

##### ASSESSMENT OF AVAILABLE DATA

###### Basin Mapping

U.S. Geological Survey 7.5-minute quadrangle maps with a scale of 1:24000 and contour intervals of 5 feet were used to determine basin areas.

###### Precipitation Stations

There is one official hourly recording precipitation gage in the Wichita Falls area.

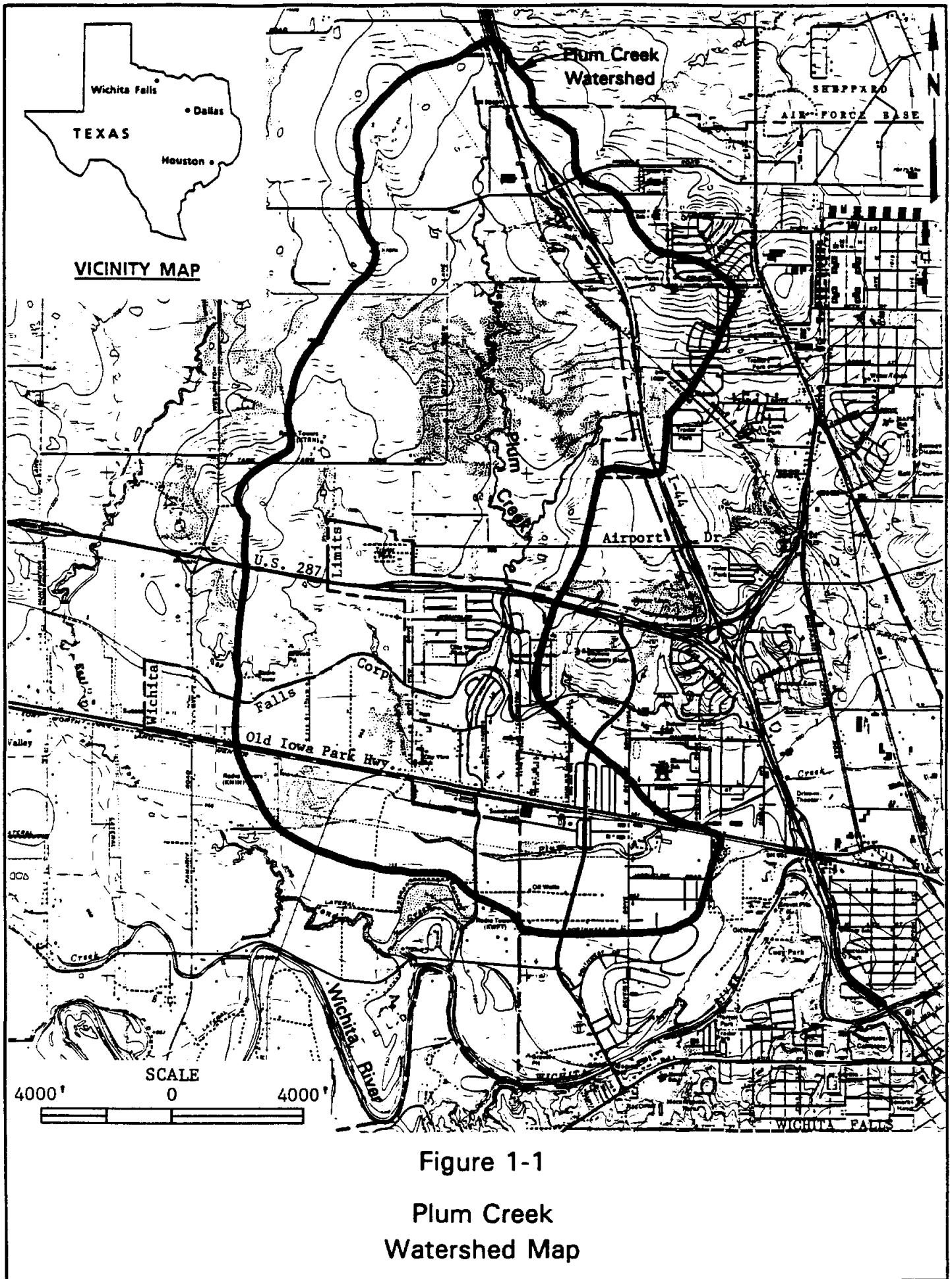

TABLE 1-1

MAJOR STORMS OCCURRING IN THE WICHITA FALLS AREA  
(May 1940 to August 1989)

Duration (hours)	Duration (days)	Precipitation (inches)	Start Time	Start Date
1		2.50	2000	5/22/1975
3		4.21	2300	6/24/1961
6		5.10	1900	5/22/1975
12		5.65	0100	9/13/1976
24	1	6.35	1200	10/29/1941
24	1	5.36	0200	6/05/1985
48	2	5.07	0800	5/12/1982
72	3	7.29	2300	9/26/1980
168	7	8.95	0400	5/22/1987
240	10	9.22	1600	5/19/1987
336	14	11.67	1900	4/20/1957
720	30	18.11	0100	4/19/1957
1,440	60	23.39	1200	4/27/1982
2,160	90	25.10	0800	3/20/1957

TABLE 1-2

AVERAGE MONTHLY PRECIPITATION  
(Wichita Falls)

Month	Precipitation (inches)
January	1.08
February	1.28
March	1.79
April	2.86
May	4.53
June	3.56
July	1.92
August	2.12
September	3.25
October	2.97
November	1.45
December	1.39

## RAINFALL-RUNOFF PROCEDURES

### Watershed Model

The Plum Creek rainfall-runoff model was developed using the Corps of Engineers computer program 723-X6-L2010, "HEC-1 Flood Hydrograph Package," PC version dated June 1988. The basin was divided into seven subareas ranging in size from 0.36 to 2.98 square miles. Snyder's unit hydrograph coefficients  $T_p$  and  $C_p$ , rainfall amounts, and routing criteria were developed as input into the HEC-1 model. Twenty-four-hour-duration rainfall was input into the model. A 30-minute computation interval was used. Figure 1-2 shows the HEC-1 subarea divisions.

### Unit Hydrograph Coefficients

Snyder's unit hydrograph coefficients were developed for each subarea from a regression analysis of regional data as presented in the June 1985 Lake Wichita, Holliday Creek, Texas Design Memorandum No. 1, and in the July 1985 feasibility report Flood Control on McGrath Creek, Wichita Falls, Texas. The method relates streambed slope, stream length, subarea shape, and hydrograph peaking time, and is illustrated by the curve in Figure 1-3, relating  $T_p$  and  $L \cdot L_{ca} / s^{1/2}$ . A  $C_p$  value of 0.85 was adopted for all subareas. Since approximately 87% of the watershed is undeveloped land and is likely to remain so, no adjustment was made for urbanization. Table 1-3 lists the unit hydrograph values developed for the various subareas.

### Loss Rates

An initial loss rate of 1.4 inches and a uniform loss rate of 0.05 inches per hour were used for all subareas, based on those listed in Lake Wichita, Holliday Creek, Texas Design Memorandum No. 1.

### Routing Criteria

The Muskingum method of routing was used to route the flood flows as adopted from the April 1989, Wichita Falls, Texas, Flood Insurance Restudy.

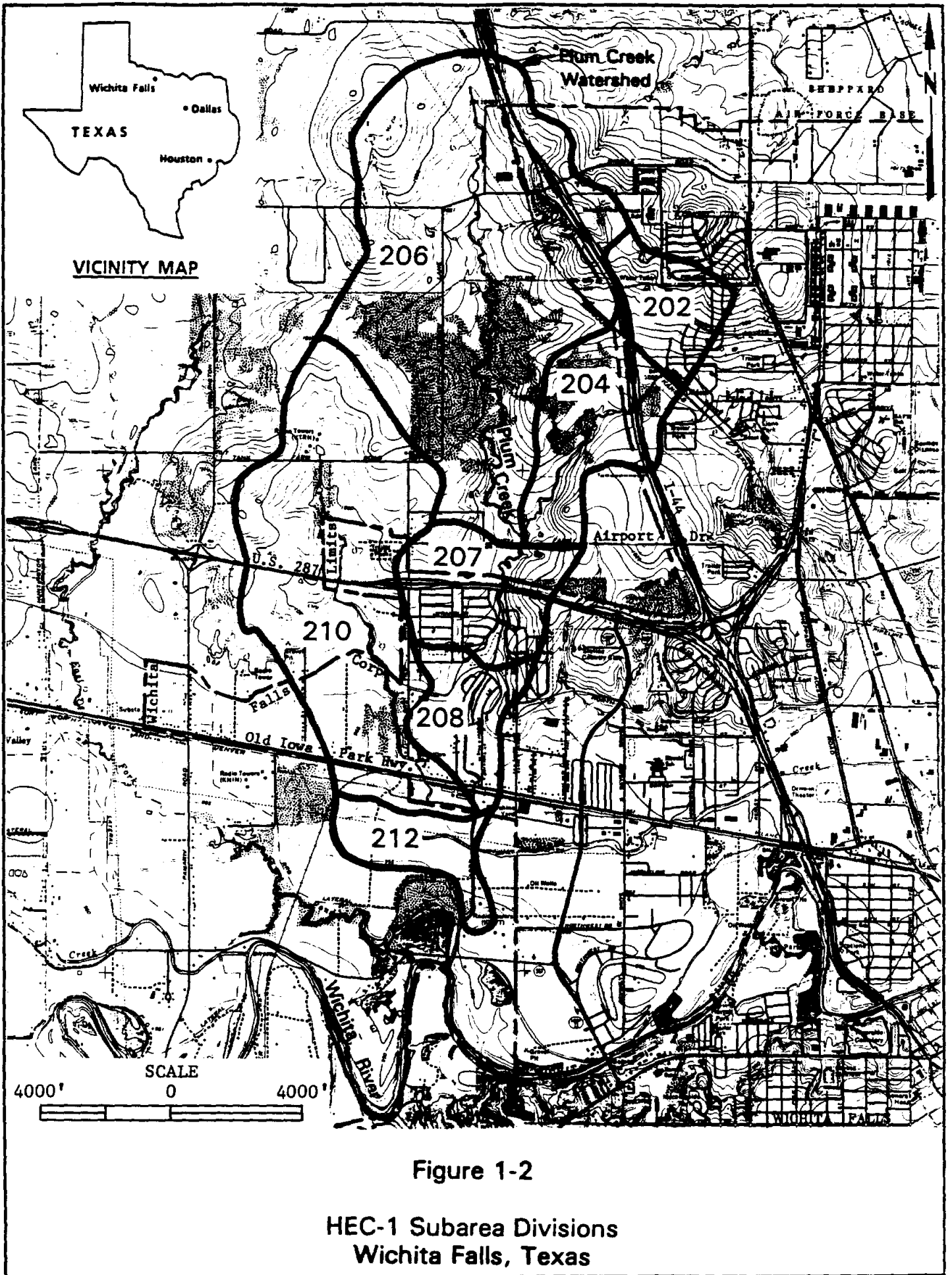

Figure 1-2

HEC-1 Subarea Divisions  
Wichita Falls, Texas

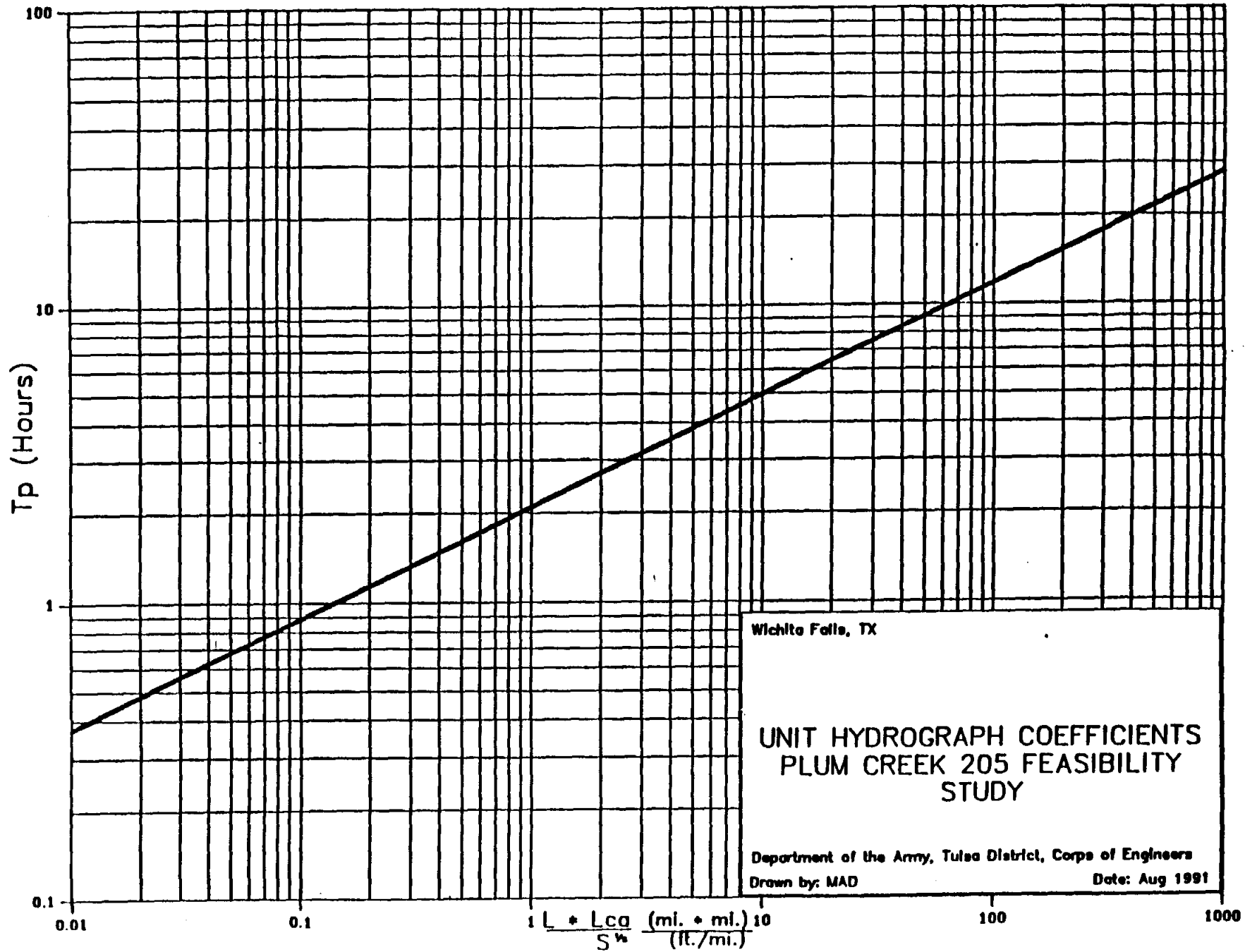



TABLE 1-3

SNYDER'S UNIT HYDROGRAPH DATA  
(Plum Creek, Wichita Falls)

Subarea Name	Area (Sq Mi)	Length (Mi)	L <sub>CA</sub> (Mi)	Slope (Ft/Mi)	L*L <sub>CA</sub>	T <sub>P</sub> (Hr)	Q <sub>P</sub> (CFS/Sq Mi)	C <sub>P</sub> * (Q <sub>P</sub> *T <sub>P</sub> /640)
202	0.36	1.00	0.30	38.00	0.30	0.67	516.5	0.544
204	0.74	1.40	0.70	32.00	0.98	1.09	425.5	0.722
206	2.98	3.30	1.80	16.70	5.94	2.42	307.5	1.161
207	0.62	0.90	0.45	10.00	0.41	0.97	444.7	0.677
208	0.37	1.10	0.59	18.18	0.65	1.04	433.8	0.702
210	2.10	3.30	1.80	18.20	5.94	2.38	309.5	1.150
212	0.36	1.20	0.60	4.00	0.72	1.43	380.5	0.850
302	1.34	1.70	0.80	4.00	1.36	1.82	345.3	0.980

\* Used a standard C<sub>p</sub> of 0.85

## FLOOD PROBABILITY

### Hypothetical Storms

Hypothetical rainfall was adopted from the July 1985 feasibility report, Flood Control on McGrath Creek, Wichita Falls, Texas. The rainfall was developed using U.S. Weather Bureau Technical Paper No. 40 (TP 40) with an adjustment for depth versus drainage area. Regional adjustments were made to the rainfall based on United States Geological Survey Publication WRI 77-110. Adjustments were also made for partial duration and expected probability. The frequency rainfall is listed in Table 1-4. The 1-, 2-, 5-, 10-, 25-, 50-, 100-, and 200-year frequency rainfall values were temporally distributed based on a triangular distribution. The 100-year, TP 40, 24-hour point rainfall distribution factors are shown in Table 1-5. The Standard Project Storm (SPS) was developed and temporally distributed based on Engineer Manual (EM) 1110-2-1411 and a Southwestern Division (SWD) letter dated 18 September 1973, subject: "Maximum 6-Hour Rainfall Distribution of the Standard Project and Probable Maximum Storms." The Probable Maximum Storm (PMS) rainfall was taken from HMR-51 and was temporally distributed based on EM 1110-2-1411 and the SWD letter dated 18 September 1973. The SPS 96-hour point rainfall distributions are shown in Table 1-6. The PMS 96-hour point rainfall distributions are shown in Table 1-7.

TABLE 1-4

FREQUENCY RAINFALL WITH REGIONAL  
AND PARTIAL DURATION FACTORS  
(24-Hour Rainfall in Inches)

Frequency Years	(1) TP 40 Rainfall	Regional Adjustment Factor	Partial Duration Factor	Adjusted Rainfall	(2) Design Rainfall
SPF	-	-	-	-	18.62
200	-	-	-	-	12.81
100	8.53	1.00	-	8.53	9.65
50	7.55	0.90	-	6.80	7.29
25	6.67	0.80	-	5.33	5.59
10	5.59	0.69	1.01	3.90	4.06
5	4.51	0.64	1.02	2.94	3.21
2	3.58	0.58	1.15	2.39	2.44
1					1.72 (3)

- (1) Adjusted for Depth Area  
(2) Expected Probability Adjustment Included  
(3) Extrapolated Value

TABLE 1-5

## 100-YEAR, TP 40, 24-HOUR POINT RAINFALL

<u>Time</u> <u>(30-Minute Ordinates)</u>	<u>Rainfall</u> <u>(Critical Arrangement)</u>
1- 6	0.05
7- 9	0.06
10- 1	0.07
12-14	0.08
15-16	0.09
17	0.01
18	0.12
19	0.14
20	0.18
21	0.20
22	0.28
23	0.43
24	0.90
25	1.85
26	0.48
27	0.41
28	0.27
29	0.20
30	0.17
31	0.12
32-33	0.10
34-35	0.09
36-37	0.08
38-39	0.07
40-42	0.06
43-48	0.05

TABLE 1-6

SPS 96-HOUR POINT RAINFALL

Time (30-Minute Ordinates)	Rainfall (Critical Arrangement)
0- 12	0.002
13- 24	0.004
25- 36	0.019
37- 48	0.003
49- 60	0.010
61- 72	0.023
73- 84	0.106
85- 96	0.015
97-108	0.082
109-120	0.197
121	0.214
122	0.427
123	0.427
124	0.641
125	1.174
126	1.815
127	3.523
128	0.854
129	0.534
130	0.427
131	0.427
132	0.214
133-144	0.124
145-156	0.005
157-168	0.012
169-180	0.053
181-192	0.007

TABLE 1-7

## PMS 96-HOUR POINT RAINFALL

---

Time (30-Minute Ordinates)	Rainfall (Critical Arrangement)
1- 12	0.001
13- 24	0.006
25- 36	0.048
37- 48	0.003
49- 60	0.008
61- 72	0.038
73- 84	0.311
85- 96	0.019
97-108	0.065
109-120	0.323
121	0.644
122	1.288
123	1.288
124	1.932
125	3.542
126	5.475
127	10.627
128	2.576
129	1.610
130	1.288
131	1.288
132	0.644
133-144	0.162
145-156	0.004
157-168	0.021
169-180	0.173
181-192	0.010

---

## Discharge-Frequency Data

Frequency discharges were derived by inputting the adjusted hypothetical rainfall into the HEC-1 computer model. Peak discharges for existing conditions at key locations in the basin are shown in Table 1-8. The discharge-frequency curve for existing conditions at the proposed detention site is shown in Figure 1-4.

TABLE 1-8

### PLUM CREEK PEAK DISCHARGES (cubic feet per second)

Frequency Event	Detention Site (Below)		Old Iowa Park Highway*		Outlet*	
	(1)	(2)	(1)	(2)	(1)	(2)
1-Yr	14	4	13	5	21	14
2-Yr	380	80	400	120	630	420
5-Yr	850	230	860	270	1370	930
10-Yr	1340	340	1270	420	2020	1480
25-Yr	2210	510	2020	670	3080	2420
50-Yr	3110	680	3070	900	4790	3320
100-Yr	4250	1450	4350	1390	6800	4450
200-Yr	5690	2840	5910	2880	9380	5880
SPF	7070	4970	7330	5320	11680	8800

(1) Existing Conditions  
 (2) Modified Conditions: Crest Elevation = 1002  
 Maximum Pool = 1011  
 Spillway Width = 165 feet  
 \* See HEC-2 output for reduction due to split flow

# EXCEEDENCE FREQUENCY PER 100 YEARS

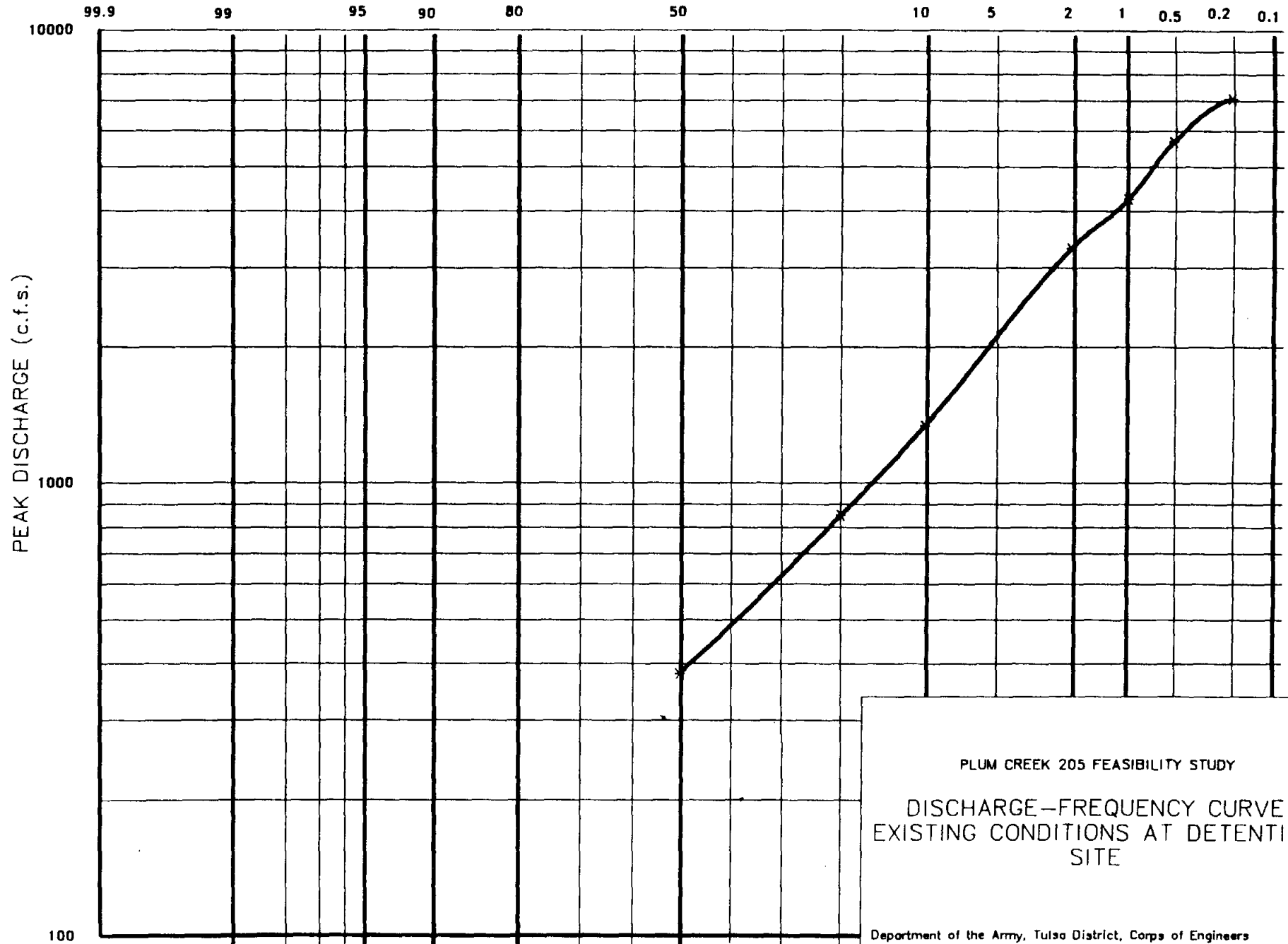

PLUM CREEK 205 FEASIBILITY STUDY  
DISCHARGE-FREQUENCY CURVE  
EXISTING CONDITIONS AT DETENTION  
SITE  
Department of the Army, Tulsa District, Corps of Engineers  
Drawn by: MAD  
Date: APR 1992

1-13

FIGURE 1-4

## PLUM CREEK HYDRAULICS

### ASSESSMENT OF AVAILABLE DATA

#### Topographic Mapping

Photogrammetric mapping flown in March 1986, with a scale of 1" = 200' and 1" = 600' and a contour interval of 2 feet, was used for the study.

#### Cross Sections

Cross sections were either developed from 1" = 200' topographic mapping or taken from the April 1989 Wichita Falls Type 19 Flood Insurance Restudy for Plum Creek. The bridges in the study area were measured to develop and verify bridge geometry.

### EXISTING WATER SURFACE PROFILE COMPUTATIONS

Water surface profiles for the 1-, 2-, 5-, 10-, 25-, 50-, 100-, 200-year, and SPF floods were computed using the Corps of Engineer computer program 723-X6-L202A, "HEC-2 Water Surface Profiles," PC version dated October 1990. Manning's "n" values ranged from 0.013 to 0.09 in the channel, and from 0.055 to 0.125 in the overbanks. Starting water surface elevations were based on the normal depth option contained in the HEC-2 program. An area of split flow was modeled in the basin between cross sections 58+77 and 79+15 where a ridge exists along the east overbank. Flow overtopping this ridge leaves the Plum Creek watershed. Plates 1-1 and 1-2 show the plotted water surface profiles for existing conditions.

### MODIFIED CONDITIONS

Two major flood control options were analyzed in this study. One option included widening an area of improved channel along the urbanized reaches of Plum Creek to increase the flow carrying capacity of the channel. A second option was construction of an upstream dry detention pond to hold runoff during flood events. Both flood control options were designed and economically optimized based on physical site constraints to minimize flooding, but were not designed for a particular flood frequency.

#### Channel Improvement Option

To evaluate the channel improvement option, the CHIMP routine in the HEC-2 program was utilized to simulate the widening of the existing reach of concrete-lined channel between the North Side Irrigation Canal and the Old Iowa Park Highway. The bottom width of the channel was increased by 10 feet about the existing centerline of the channel, and side slopes of 3 horizontal to 1 vertical were modeled. The widening of the channel was



constrained by the existence of single-family housing along both sides of Plum Creek. The channel improvement reduced the water surface elevations along the widened reach an average of 0.9 feet for both the 10- and the 100-year floods.

### **Upstream Detention Option (Selected Option)**

At the upper end of the watershed, upstream of all urbanized areas, there is adequate topographic relief to provide a suitable location for a detention structure. The dam location and alignment chosen for the study are shown in Figure 1-5.

### **DETENTION STRUCTURE CAPACITY**

#### **Area-Capacity Data**

Area and capacity data were developed from 1" = 600' topographic mapping. The elevation-area-capacity data are presented in Table 1-9.

#### **Sedimentation**

There are no recorded data on sedimentation or degradation in the Plum Creek watershed. Therefore, a sediment load of 466 acre-feet for a 100-year sediment pool life was estimated for this study based on an analysis of soil samples taken from the basin, land use in the upper reaches of the watershed, and available sediment data from gages in the region. The soil type identified in the upper portion of the watershed is silty loam which is highly erodible without vegetative cover. The existing native grasses and trees provide moderate protection against erosion.

#### **Maximum Pool Elevation**

Several physical constraints were considered when sizing the upstream detention structure. Concern over possible inundation of the Central Freeway during higher frequency rainfall events served to constrain the maximum pool elevation on the eastern edge of the detention site. Existing structures along the western edge of the detention site provided another constraint. The detention structure, therefore, was sized by first establishing a maximum pool elevation; then by developing a family of spillway sizes such that when the Probable Maximum Flood (PMF) was routed through the detention site on top of a full flood pool with inoperative outlet works, the established maximum pool elevation was not exceeded. The maximum pool elevations selected for analysis were 1011, 1012, and 1013 National Geodetic Vertical Datum (NGVD). (These were the pool elevations that provided maximum flood control storage within the physical constraints mentioned). For each of these established maximum pool elevations, several spillway sizes were analyzed. The range of spillway sizes offered varying degrees of flood protection.

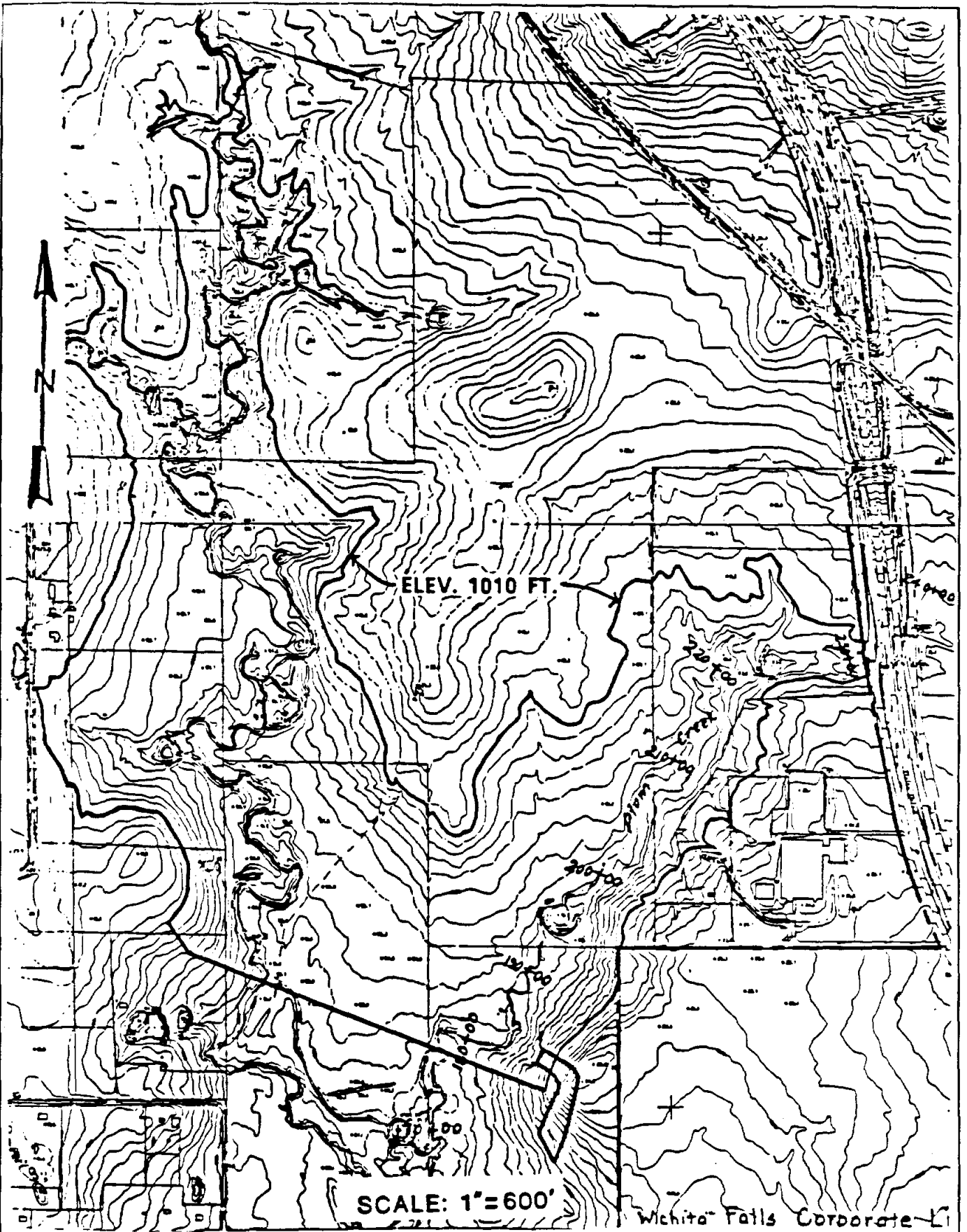

Figure 1-5

Proposed Dam Alignment  
Plum Creek Detention Structure

TABLE 1-9  
ELEVATION-AREA-CAPACITY DATA

Pool Elevation	.0	.1	.2	.3	.4	.5	.6	.7	.8	.9
986	0 0	0 0	0 0	0 0	0 0	0 0	0 0	0 0	0 0	0 0
987	1 0	1 0	1 0	1 1	1 1	1 1	1 1	1 1	2 1	2 1
988	2 2	2 2	2 2	3 2	3 3	3 3	3 3	4 4	4 4	4 4
989	5 5	5 5	5 6	5 6	6 7	6 8	6 8	7 9	7 10	8 10
990	8 11	8 12	9 13	9 14	10 15	10 16	11 17	12 18	12 19	13 20
991	13 22	14 23	15 25	15 26	16 26	16 29	17 31	18 33	19 35	19 36
992	20 38	21 40	21 43	22 45	23 47	24 50	25 52	25 54	26 57	27 60
993	26 62	29 65	30 68	30 71	31 74	32 78	33 81	34 84	35 88	36 91
994	37 95	38 99	39 102	40 107	41 111	42 115	43 119	44 123	45 128	46 132
995	47 137	48 142	50 147	51 152	52 157	53 162	54 168	55 173	57 179	59 184
996	59 190	60 196	61 202	63 209	64 215	65 222	67 228	68 235	69 242	71 248
997	72 255	73 263	75 270	76 276	77 286	79 294	80 302	82 310	83 318	85 326
998	86 334	87 343	89 352	90 361	92 370	94 380	95 389	97 399	98 408	100 418
999	101 428	103 438	105 449	106 460	108 470	110 481	111 492	113 504	115 515	116 526
1000	118 538	119 550	121 562	122 574	124 586	125 599	127 611	128 624	130 637	131 650
1001	133 663	134 676	136 690	137 704	139 718	140 732	142 746	143 760	145 774	146 789
1002	148 803	150 818	151 833	153 849	154 864	156 880	157 895	159 911	160 927	162 943
1003	164 959	165 976	167 992	168 1009	170 1026	172 1043	173 1061	175 1078	177 1095	178 1113
1004	180 1131	182 1149	183 1168	185 1186	187 1205	189 1224	190 1242	192 1262	194 1281	196 1300
1005	198 1320	199 1340	201 1360	203 1380	205 1401	207 1421	209 1442	210 1463	212 1484	214 1505
1006	216 1527	218 1548	220 1570	222 1593	224 1615	225 1637	227 1660	229 1683	231 1706	233 1729

Legend: 986 = 0 = Area (acres)  
0 = Capacity (acre-feet)

TABLE 1-9 (Continued)

Pool Elevation	.0	.1	.2	.3	.4	.5	.6	.7	.8	.9
1007	235 1752	237 1776	239 1800	241 1824	243 1848	245 1873	247 1897	249 1922	251 1947	253 1972
1008	255 1997	257 2023	259 2049	261 2075	263 2101	265 2128	268 2154	270 2181	272 2208	274 2235
1009	276 2263	278 2291	280 2319	283 2347	285 2375	287 2404	289 2433	291 2462	294 2491	296 2520
1010	298 2550	301 2580	304 2611	307 2642	311 2673	314 2704	317 2736	320 2768	324 2800	327 2832
1011	330 2864	333 2898	337 2932	340 2966	344 3000	347 3035	350 3070	354 3105	357 3140	361 3175
1012	364 3211	367 3248	371 3285	374 3323	377 3361	380 3399	384 3437	387 3475	391 3514	394 3553
1013	397 3592	401 3632	404 3673	408 3714	411 3755	414 3796	418 3838	421 3879	425 3921	428 3964
1014	432 4006									

Legend: 986 = 0 = Area (acres)  
0 = Capacity (acre-feet)

## **Top of Dam Elevation**

The top of dam was set at the maximum pool elevation plus 3 feet of freeboard to provide protection against overtopping of the dam by wind and wave action. Maximum wave height was determined using procedures outlined in Engineering Technical Letter 1110-2-305, and was found to be less than 3 feet.

## **Selected Detention Pond Alternative**

The alternative which had the highest benefit-to-cost ratio was the detention pond option with the top of dam set at elevation 1014 NGVD and the spillway crest elevation set at 1002 NGVD. The top of flood control pool corresponds with the spillway crest elevation. This option provided greater than 25-year flood protection with no releases. Pertinent data for this option are presented in Table 1-10.

## **MODIFIED DISCHARGE-FREQUENCY DATA**

Frequency discharges for modified conditions were derived by adding a Modified Puls routing step to the existing conditions HEC-1 model to simulate the existence of the detention structure. Table 1-8 lists the peak discharges for modified conditions at key locations in the basin. Figures 1-6 and 1-7 show the operational hydrograph of the 100-year flood routed through the detention pond starting with an empty flood control pool at year zero. Figures 1-8 and 1-9 show the operational hydrograph of the 100-year flood routed through the detention pond starting with an empty flood control pool at year 100.

## **MODIFIED WATER SURFACE PROFILE COMPUTATIONS**

Water surface profiles for modified conditions were computed by inserting the frequency discharges developed for modified conditions into the existing conditions HEC-2 model. Plates 1-3 and 1-4 show the plotted water surface profiles for modified conditions. Plate 1-5 shows the flooded area outlines for the 100-year and the SPF events (modified conditions).

## **OUTLET WORKS**

### **Inlet Apron**

The entrance to the concrete outlet pipe will consist of a slopewall apron structure (headwall) as shown in Appendix 5, Drawing 49/1. The entrance to the conduit will be protected from debris with a gated trashrack placed over the conduit entrance. The trashrack bars should be spaced to stop only the debris which could block the conduit.

TABLE 1-10

PERTINENT DATA FOR  
UPSTREAM DRY DETENTION  
PLUM CREEK, WICHITA FALLS, TEXAS

Feature	At Year 50	At Year 100
<b>GENERAL</b>		
Drainage Area, above damsite, sq mi	4.08	4.08
<b>ELEVATION, feet, National Geodetic Vertical Datum (NGVD)</b>		
Top of Dam	1014	1014
Maximum Pool	1011	1011
Top of Flood Control Pool	1002	1002
Top of Inactive Pool (1)	991.8	997.2
Streambed	985.2	985.2
<b>STORAGE, acre-feet</b>		
Flood Control	768 (2)	535 (3)
Inactive (1)	233	466
<b>AREA, acres</b>		
Top of Flood Control Pool	148	148
<b>SPILLWAY</b>		
Location	Abutment	Abutment
Type	Uncontrolled	Uncontrolled
Side Slopes (horizontal/vertical)	3/1	3/1
Width, feet	165	165
Crest Elevation, feet, MSL	1002	1002
Approx. Freq. of Filling, years	> 25 yrs	> 10 yrs
Discharge at Max. Pool, cfs, Total	14,160	14,160
<b>FLOOD CONTROL OUTLET WORKS</b>		
Type	Conduit	Conduit
Number and Size	1 - 30"	1 - 30"
Discharge at Spillway Crest, cfs	83.4	83.4
Entrance Invert Elev., feet, MSL	985.2	985.2

Note: Structure is designed with a 100-year sediment pool.

- (1) 198.3 acre-feet of inactive pool accounted for as borrow excavation for embankment fill.
- (2) > 25-Year Protection
- (3) > 10-Year Protection

1-21

FIGURE 1-6

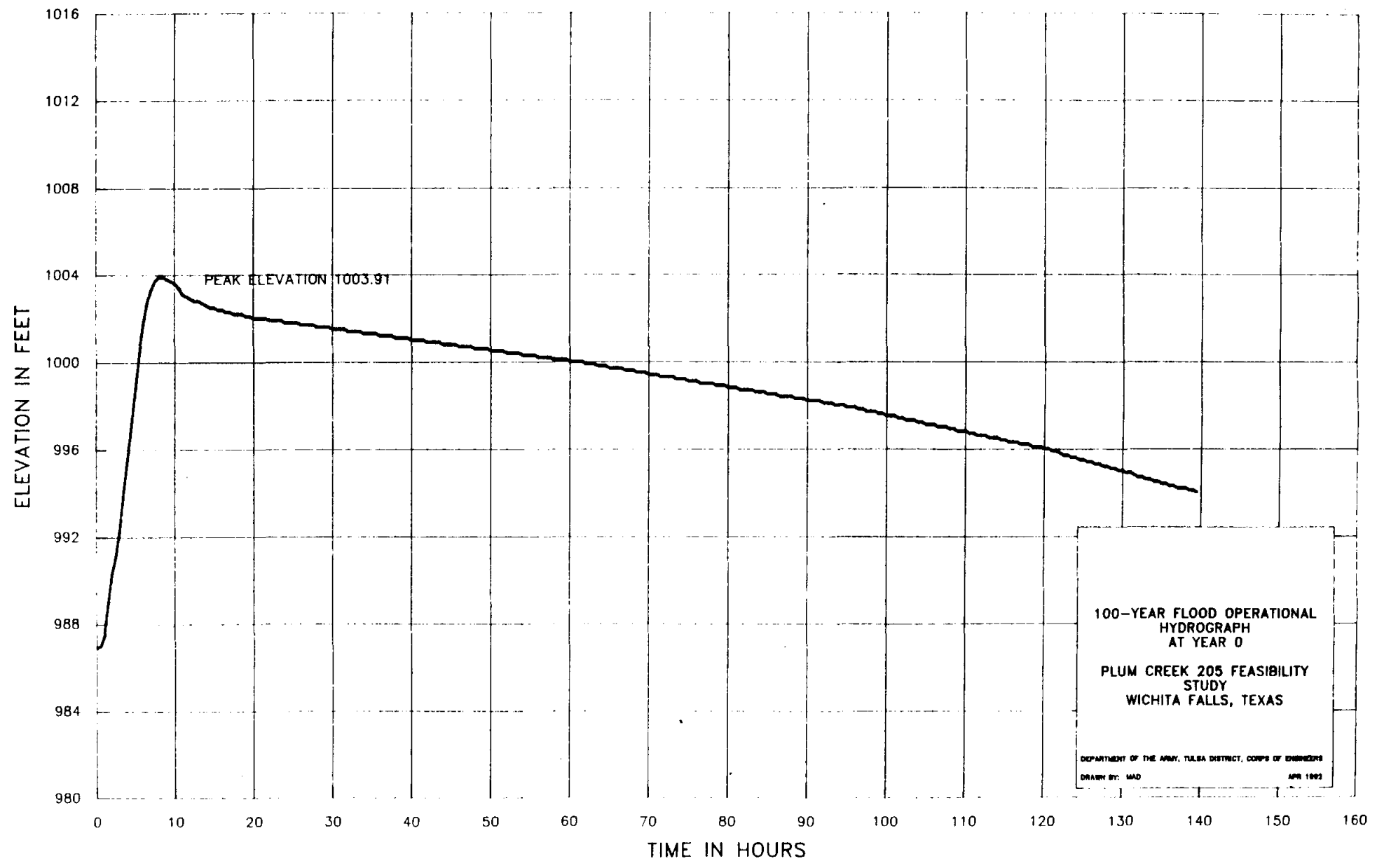

100-YEAR FLOOD OPERATIONAL  
HYDROGRAPH  
AT YEAR 0

PLUM CREEK 205 FEASIBILITY  
STUDY  
WICHITA FALLS, TEXAS

DEPARTMENT OF THE ARMY, TULSA DISTRICT, CORPS OF ENGINEERS  
DRAWN BY: MAD APR 1992

I-22

FIGURE I-7

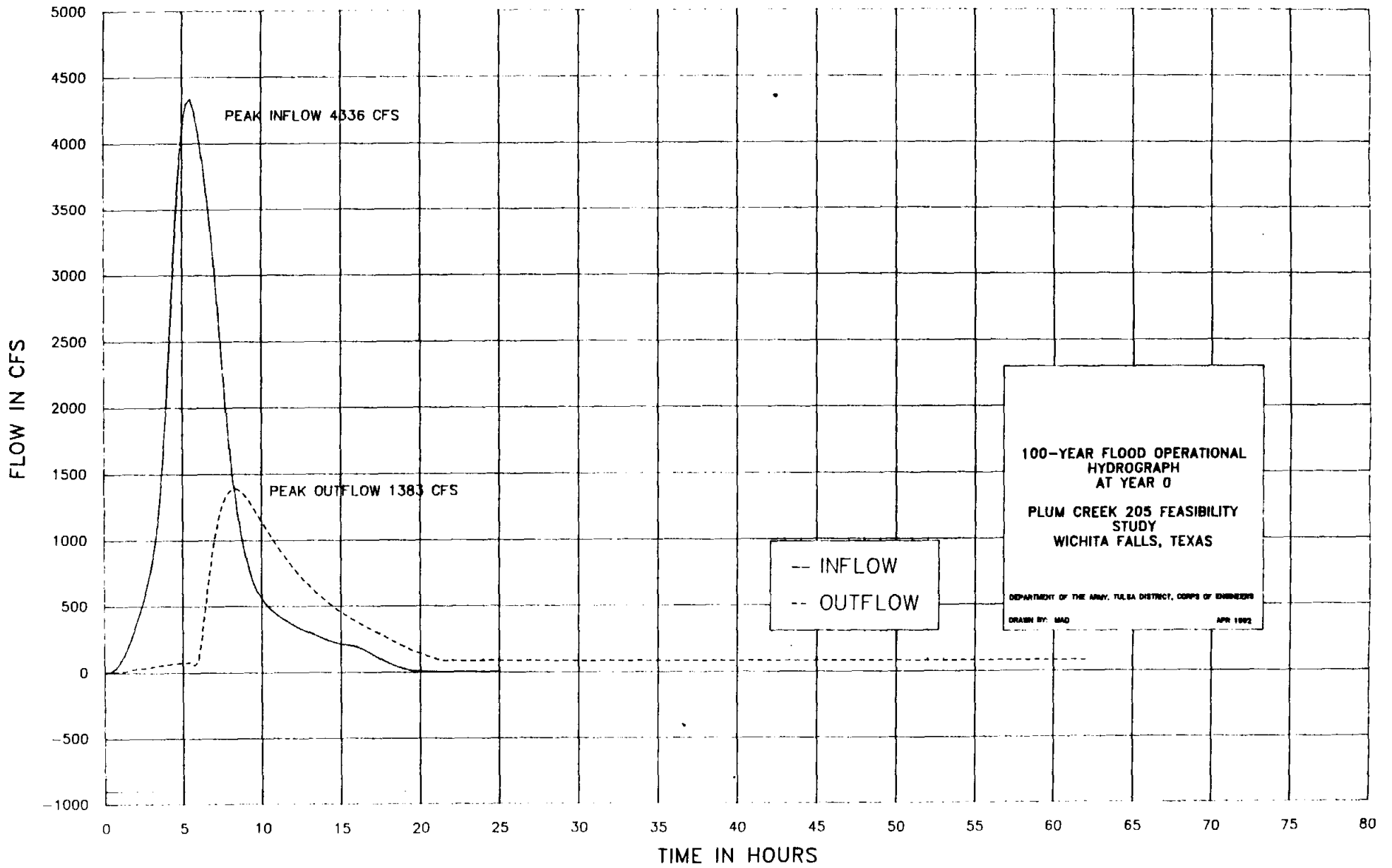



1-23

FIGURE 1-8

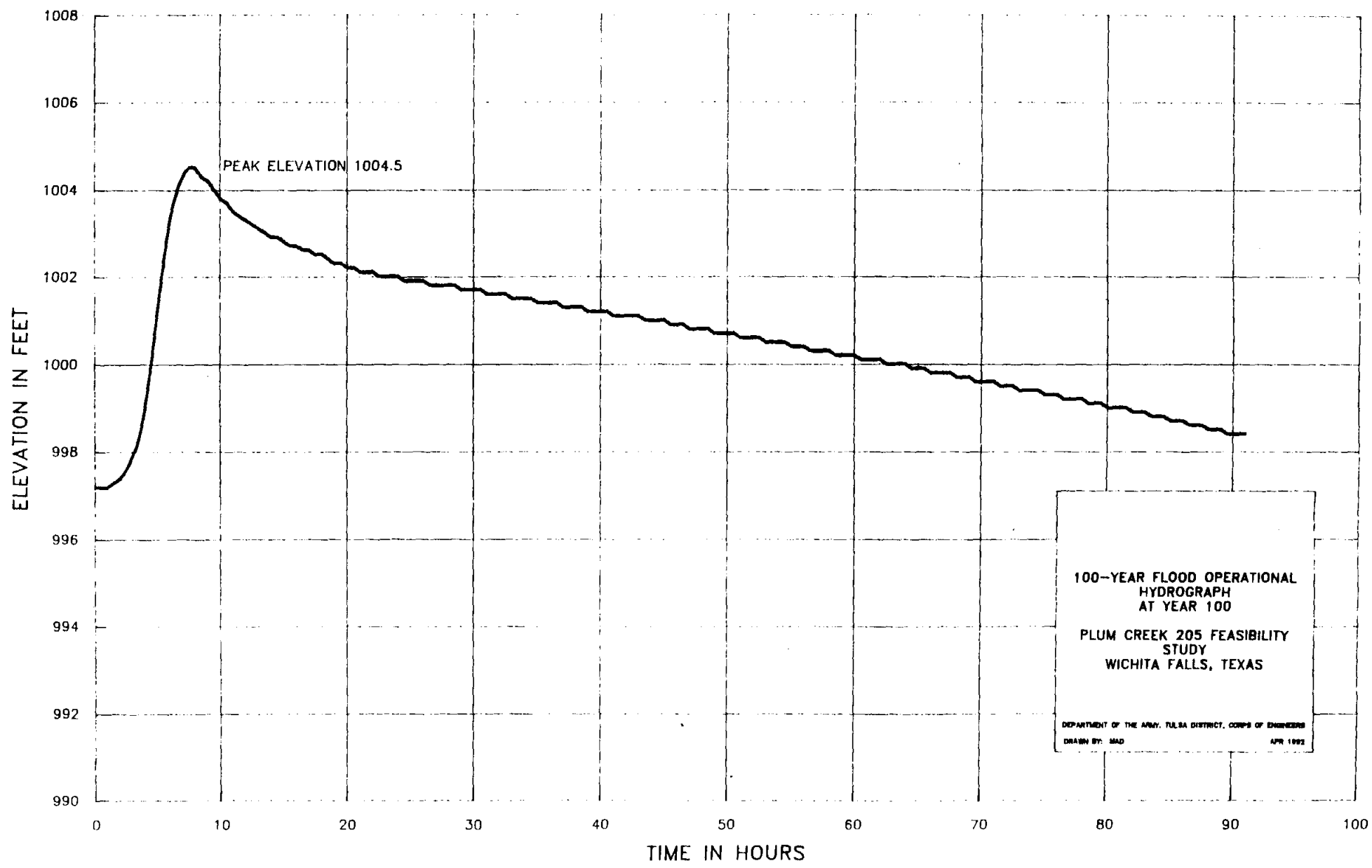

I-24

FIGURE 1-9

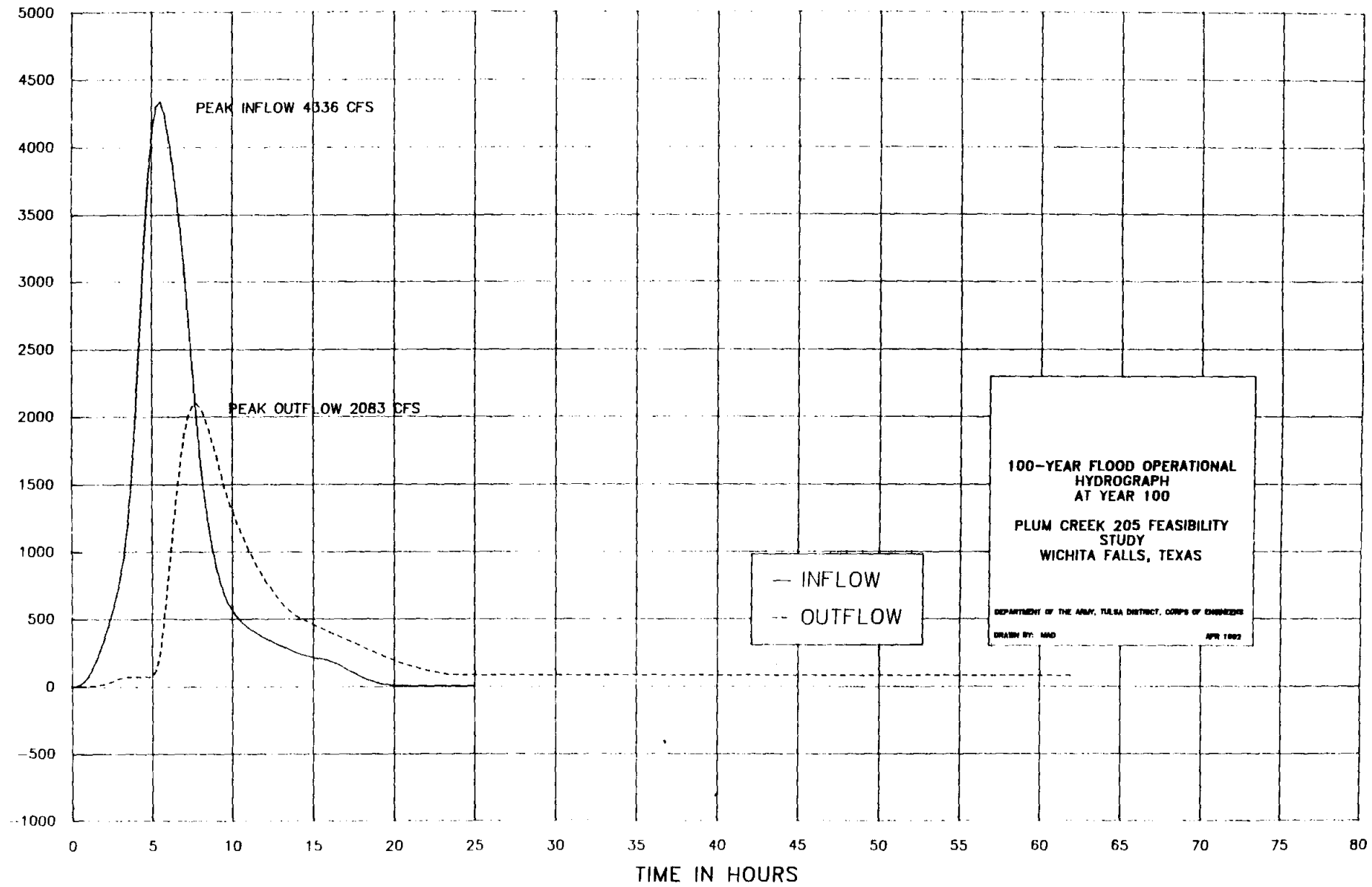

## Conduit

The concrete outlet pipe will be 30 inches in diameter. The entrance invert elevation will be set at 985.2. Discharge through the conduit at the top of the flood control pool is 83 cfs. The discharge for pressure flow was computed by the orifice equation  $Q = A(2gH/K)^{1/2}$ . Loss coefficients used were: entrance, 0.5; exit, 1.0  $h_v$ ; the friction factor for Manning's formula was taken as 0.013. The pipe will be placed near the stream invert and sloped at 0.5% for drainage.

## Exit Stilling Basin

Flow will discharge from the outlet conduit onto a concrete slopewall apron before being released into the outlet channel (Appendix 5, Drawing 49/1). Riprap will be required downstream of the apron to protect the natural channel from scour at the toe of the apron.

## EMERGENCY SPILLWAY

The emergency spillway will be cut on the eastern side of the detention pond embankment. The approach and exit slopes of the spillway will be hardened with respective slopes of 0.5% and 1.0%. The channel will be a trapezoidal shape with side slopes of 1 vertical to 3 horizontal. Spillway discharges were computed using critical control at the break point in grade at the spillway crest. Discharges were determined for critical depth plus the velocity head minus the approach losses occurring upstream from the control point. Table 1-11 lists the spillway discharge velocities at varying elevations above the spillway crest. The discharge rating curve for the emergency spillway is plotted in Figure 1-10.

---

TABLE 1-11

SPILLWAY DISCHARGE VELOCITIES

---

Pool Elevation (feet)	Velocity (fps)
1002	0.00
1003	4.42
1004	6.32
1005	7.76
1006	8.96
1007	10.00
1008	10.94
1009	11.79
1010	12.57
1011	13.30

---

1-27

ELEVATION (FT)

FIGURE 1-10

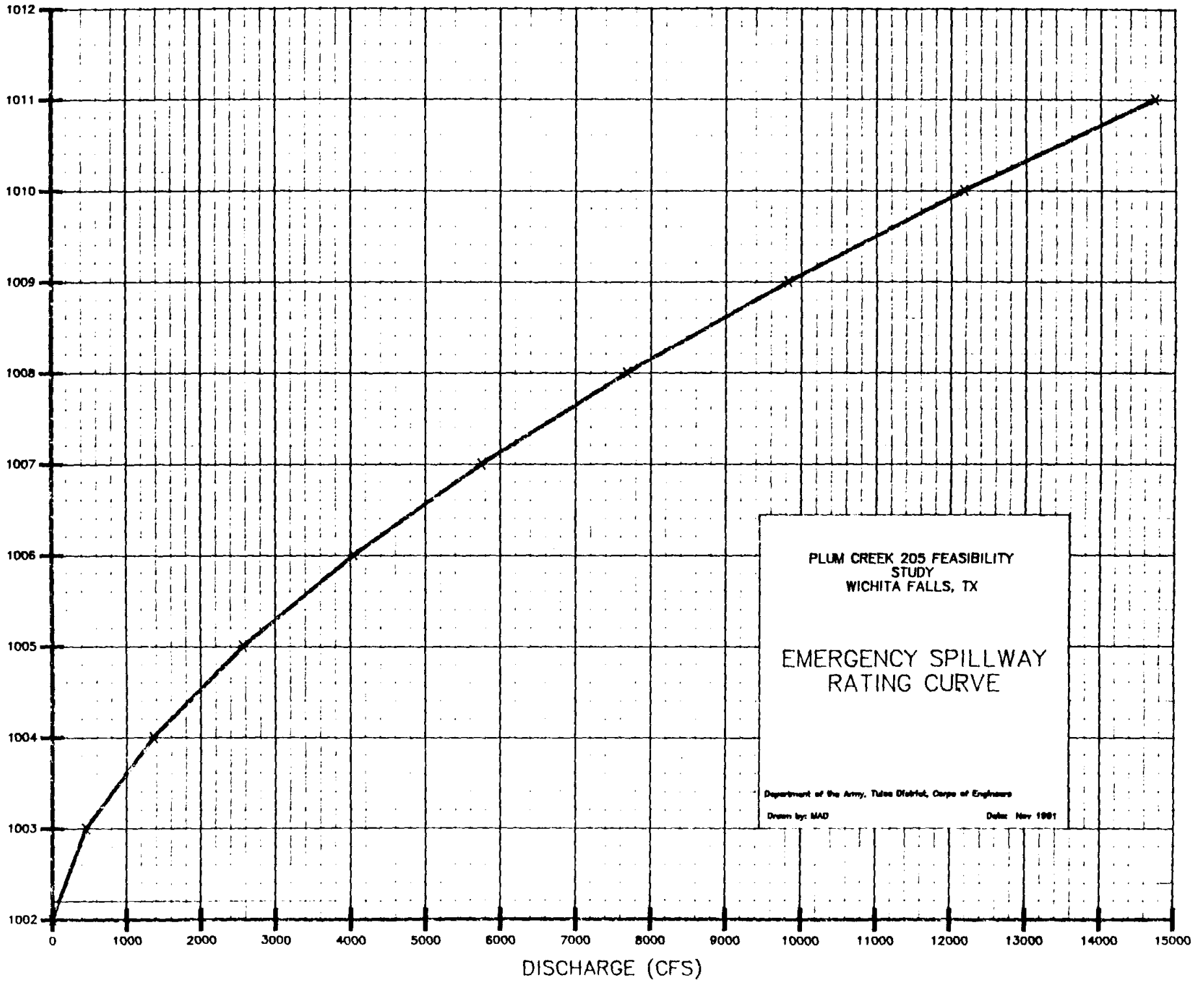

DISCHARGE (CFS)

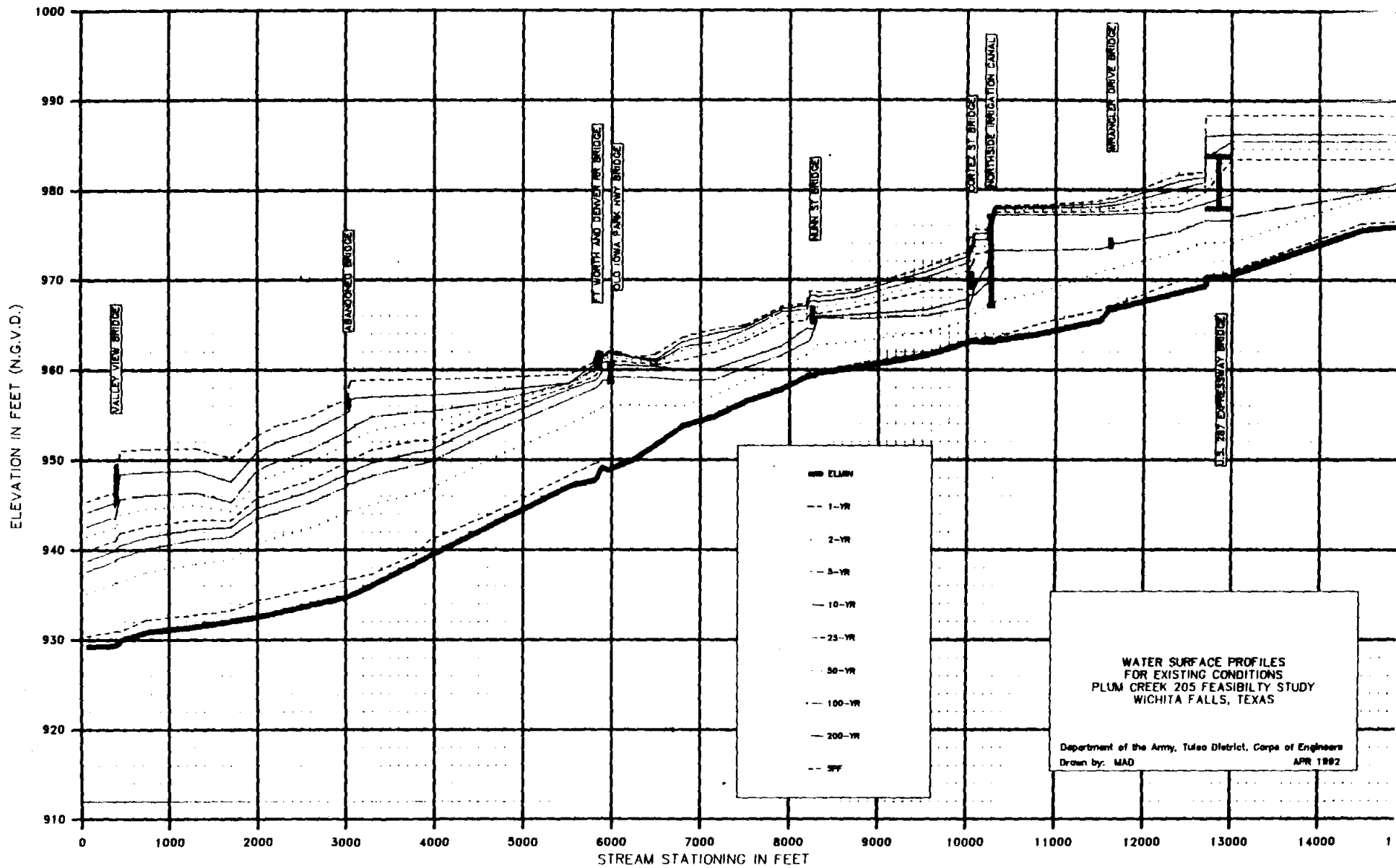

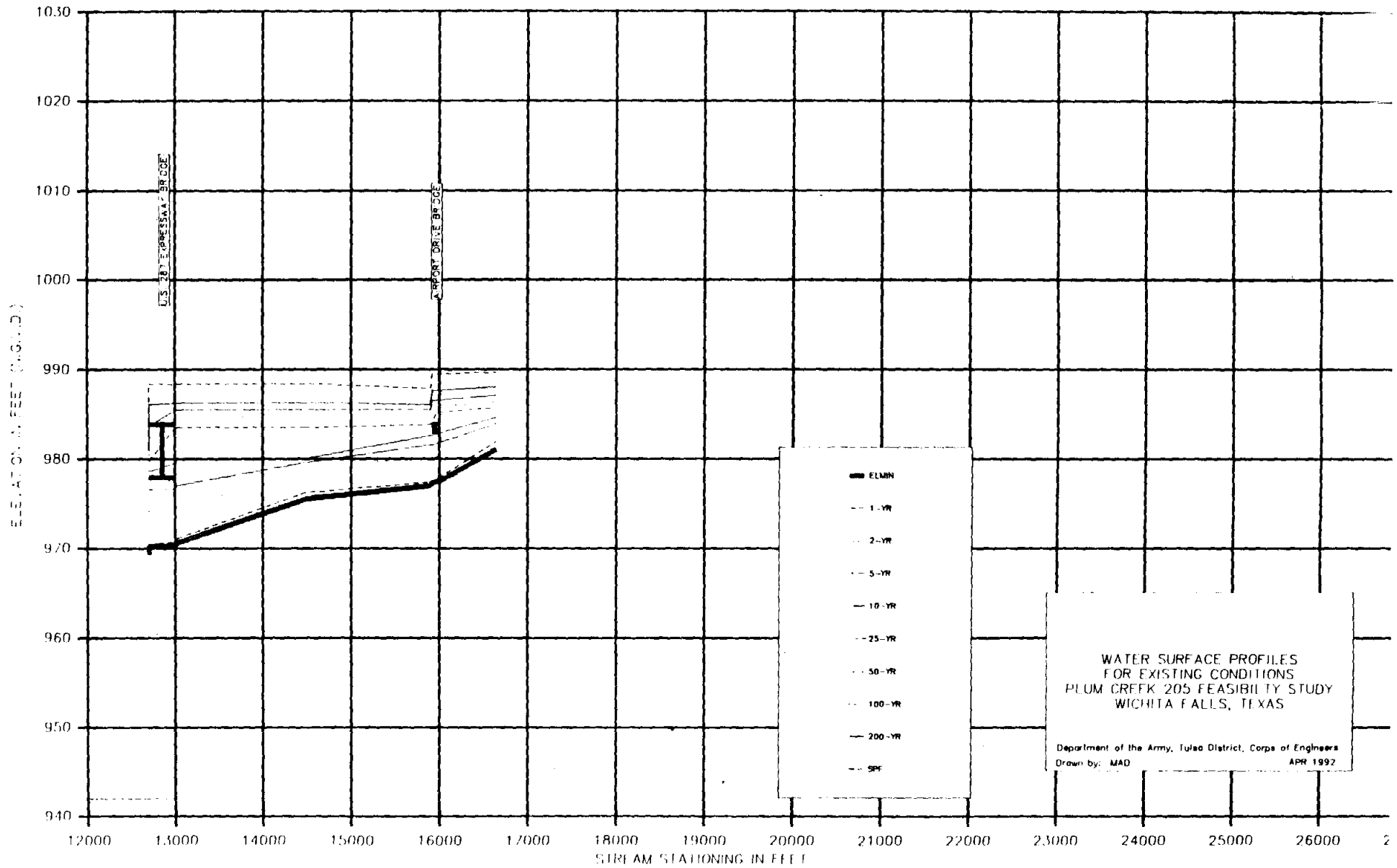

WATER SURFACE PROFILES  
FOR EXISTING CONDITIONS  
PLUM CREEK 205 FEASIBILITY STUDY  
WICHITA FALLS, TEXAS  
Department of the Army, Tulsa District, Corps of Engineers  
Drawn by: MAD APR 1992

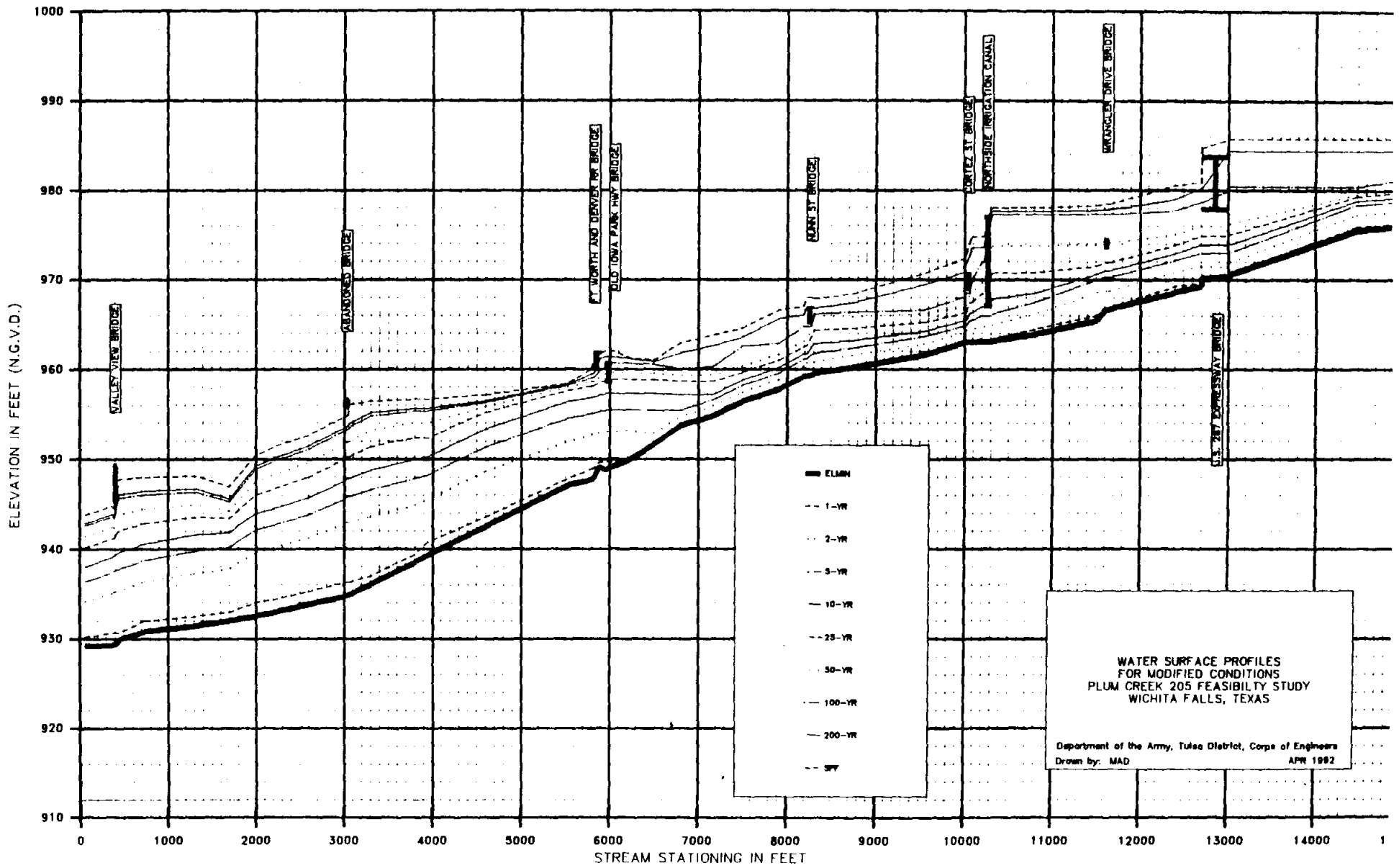



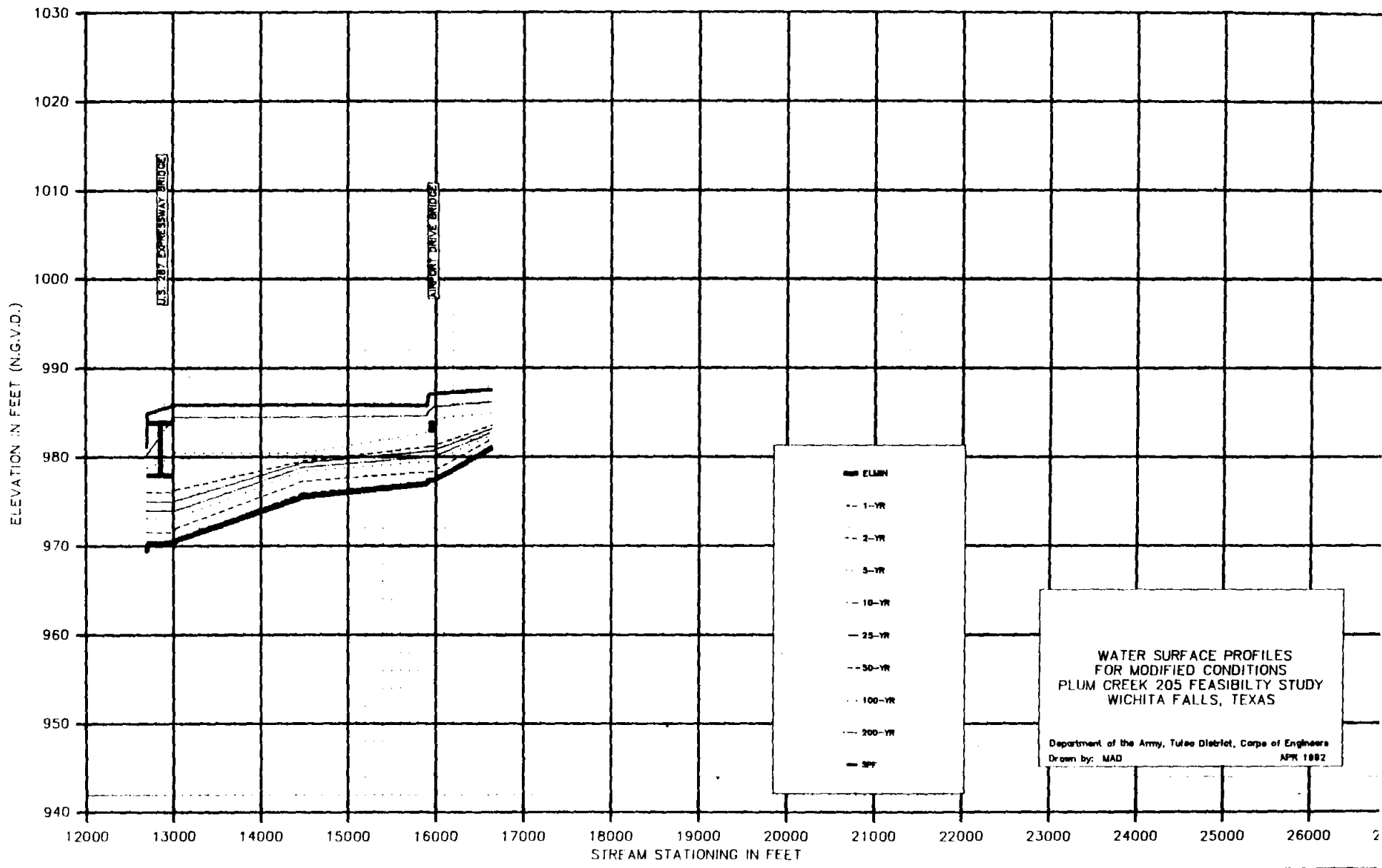

WATER SURFACE PROFILES  
FOR MODIFIED CONDITIONS  
PLUM CREEK 205 FEASIBILITY STUDY  
WICHITA FALLS, TEXAS

Department of the Army, Tulee District, Corps of Engineers  
Drawn by: MAD  
APR 1982



Match Plate 5-1 Continued

Plate 1-5  
Flooded Area Outline  
100-Year and SPF Events (Modified Conditions)



Plate 1-5 (Continued)

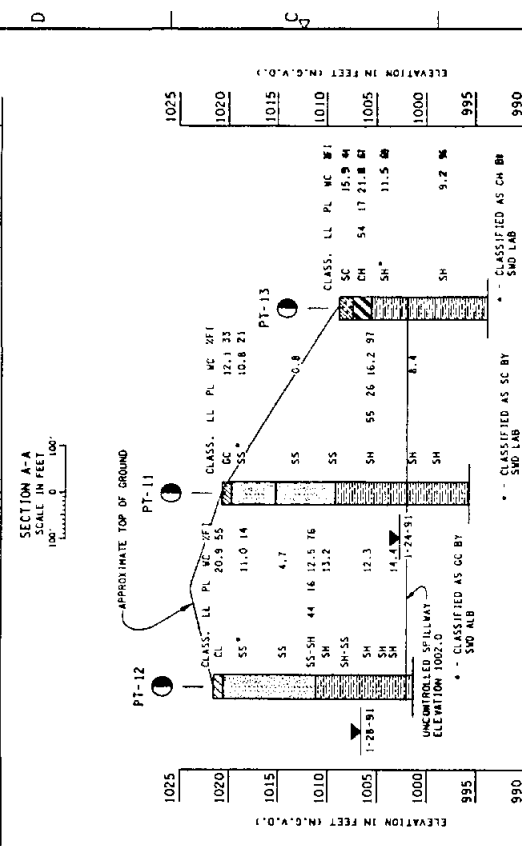
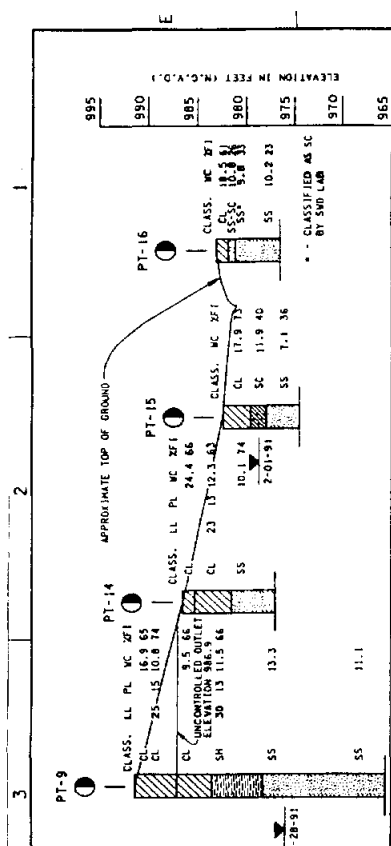
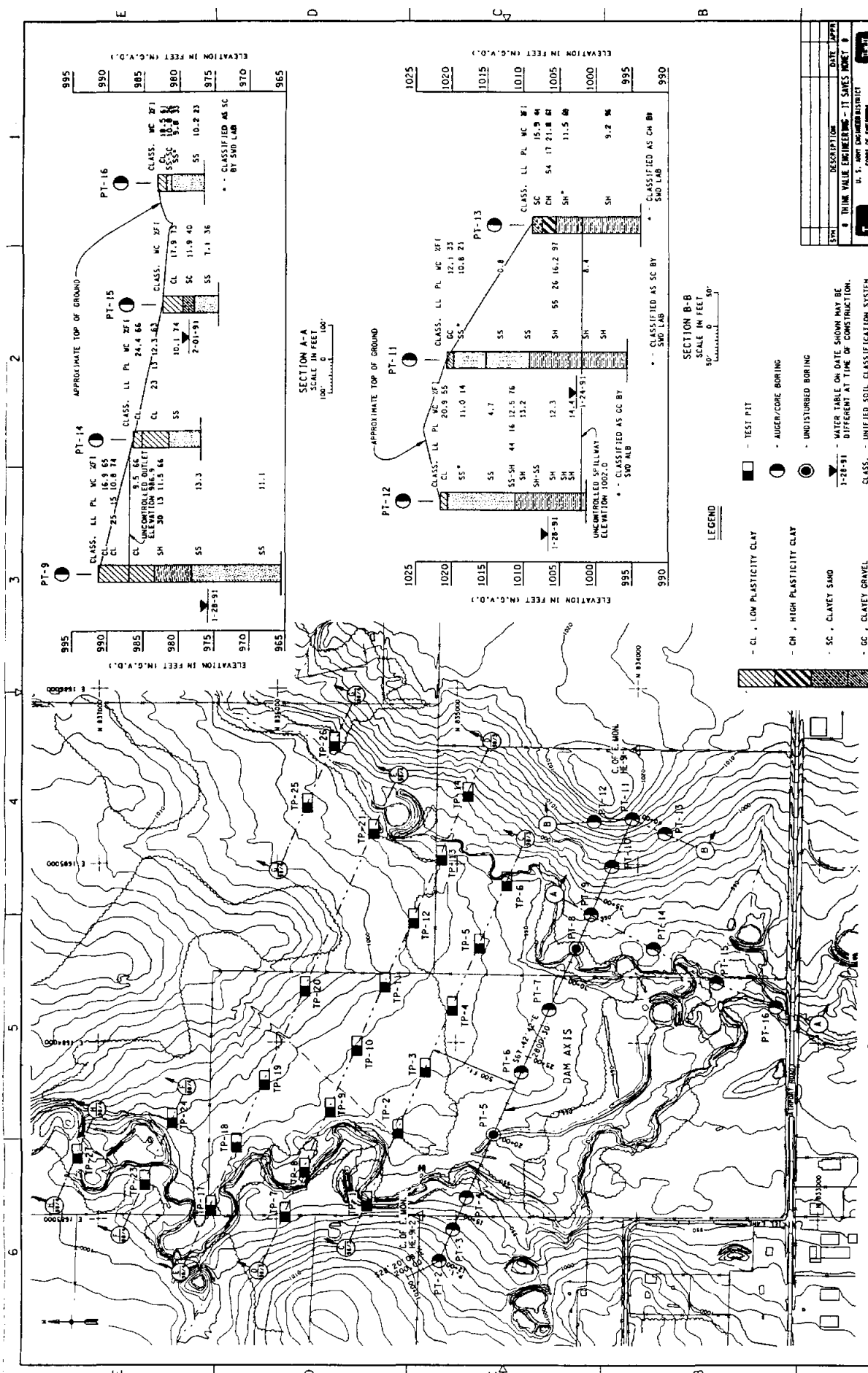

**LEGEND**

- CL - LOW PLASTICITY CLAY
- CH - HIGH PLASTICITY CLAY
- SC - CLAYEY SAND
- GC - CLAYEY GRAVEL
- SH - SHALE
- SS - SANDSTONE

**TEST PIT**

- - TEST PIT
- ⊠ - AUGER/CORE BORING
- ⊙ - UNDISTURBED BORING

**SECTION A-A**  
SCALE IN FEET  
1" = 100'

**SECTION B-B**  
SCALE IN FEET  
1" = 100'

**NOTES:**

- WATER TABLE ON DATE SHOWN MAY BE DIFFERENT AT TIME OF CONSTRUCTION.
- CLASS. - UNIFIED SOIL CLASSIFICATION SYSTEM
- LL - LIQUID LIMIT
- PL - PLASTIC LIMIT
- MC - WATER CONTENT
- WF - PERCENT FINES

**PLAN OF EXPLORATION**  
SCALE IN FEET  
200' 0 200'

**NOTES:**

- ELEVATION DATUM IS BASED ON N.G.V.D., 1929 DATUM
- COORDINATE DATUM IS BASED ON THE TEXAS STATE PLANE COORDINATE SYSTEM MAD 27, NORTH CENTRAL ZONE, (4202)
- C. OF E. MON. HE-91-1 COORDINATE DATUM IS N 834,008.719 , E 1,685,652.719 , ELEV. 1021.402
- C. OF E. MON. HE-91-2 COORDINATE DATUM IS N 835,203.302 , E 1,683,021.805 , ELEV. 951.118

**DATE APPROVED:** \_\_\_\_\_

**DESCRIPTION:** PLUM CREEK, TEXAS LOCAL FLOOD PROTECTION

**DESIGNED BY:** T. S. HARRIS ENGINEERING, INC. (T.S.H.E.)

**DRAWN BY:** \_\_\_\_\_

**CHECKED BY:** \_\_\_\_\_

**SCALE:** \_\_\_\_\_

**PROJECT NO.:** \_\_\_\_\_

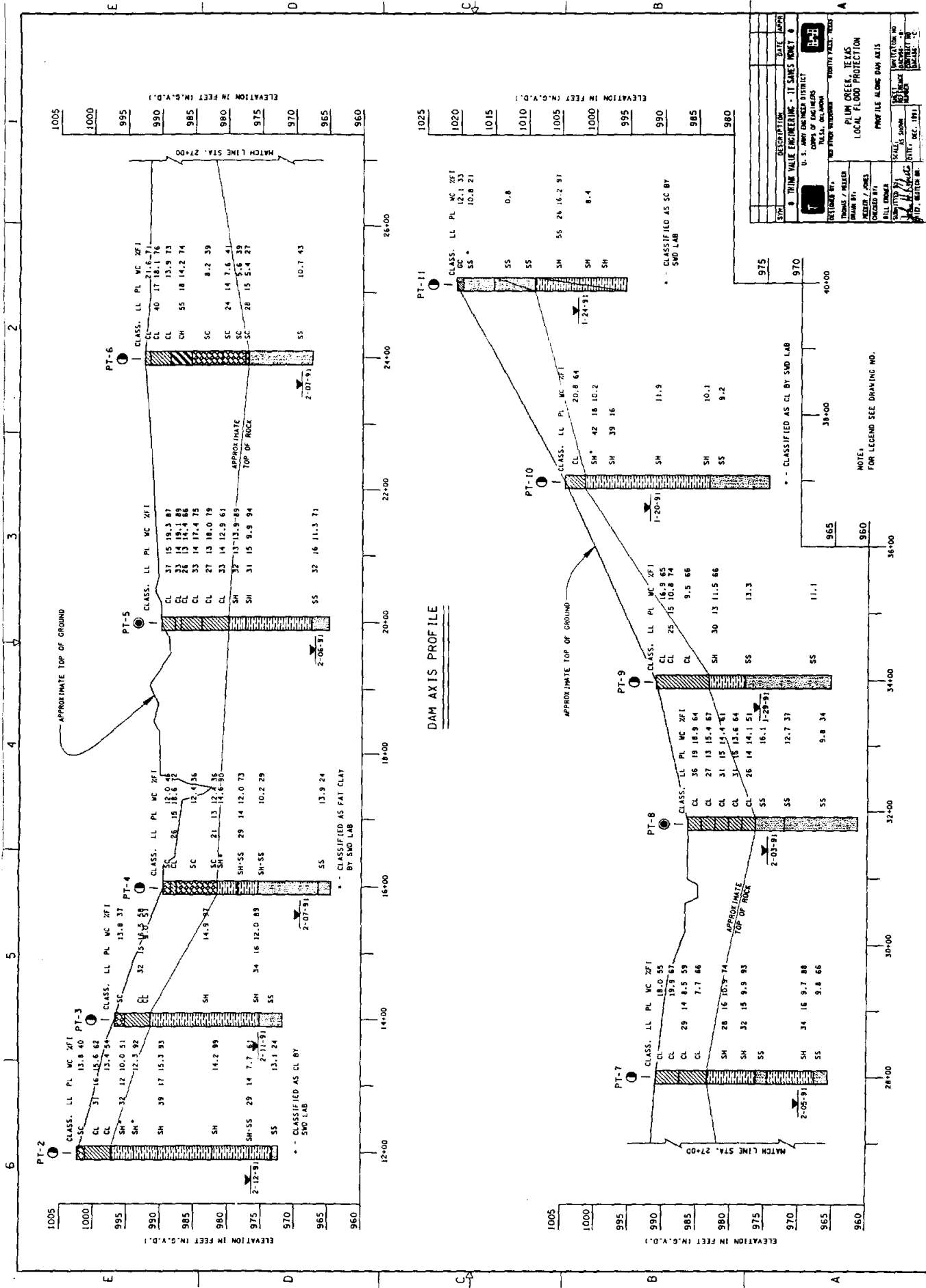

**DAM AXIS PROFILE**

STA.	DESCRIPTION	DATE	SCALE
1005	PLUM CREEK, TEXAS LOCAL FLOOD PROTECTION		
1000	DESIGNED BY: BILL DODD		
995	CHECKED BY: J. J. GAGG		
990	APPROVED BY: J. J. GAGG		
985	DATE: 12/1/81		
980	SCALE: 1" = 20' HORIZ. 1" = 2' VERT.		
975	PROJECT NO. 1005		
970	CONTRACT NO. 1005		
965	DATE: 12/1/81		
960	BY: J. J. GAGG		

U. S. ARMY ENGINEER DISTRICT  
 WET FORD DIVISION  
 PLUM CREEK, TEXAS  
 LOCAL FLOOD PROTECTION  
 PROFILE ALONG DAM AXIS  
 SCALE: 1" = 20' HORIZ. 1" = 2' VERT.  
 DATE: 12/1/81  
 BY: J. J. GAGG

NOTE: FOR LEGEND SEE DRAWING NO. 1005-1

\* - CLASSIFIED AS CL BY SMO LAB

\* - CLASSIFIED AS SC BY SMO LAB

\* - CLASSIFIED AS FAT CLAY BY SMO LAB

\* - CLASSIFIED AS CL BY SMO LAB

\* - CLASSIFIED AS CL BY SMO LAB

\* - CLASSIFIED AS CL BY SMO LAB

\* - CLASSIFIED AS CL BY SMO LAB

\* - CLASSIFIED AS CL BY SMO LAB

\* - CLASSIFIED AS CL BY SMO LAB

\* - CLASSIFIED AS CL BY SMO LAB

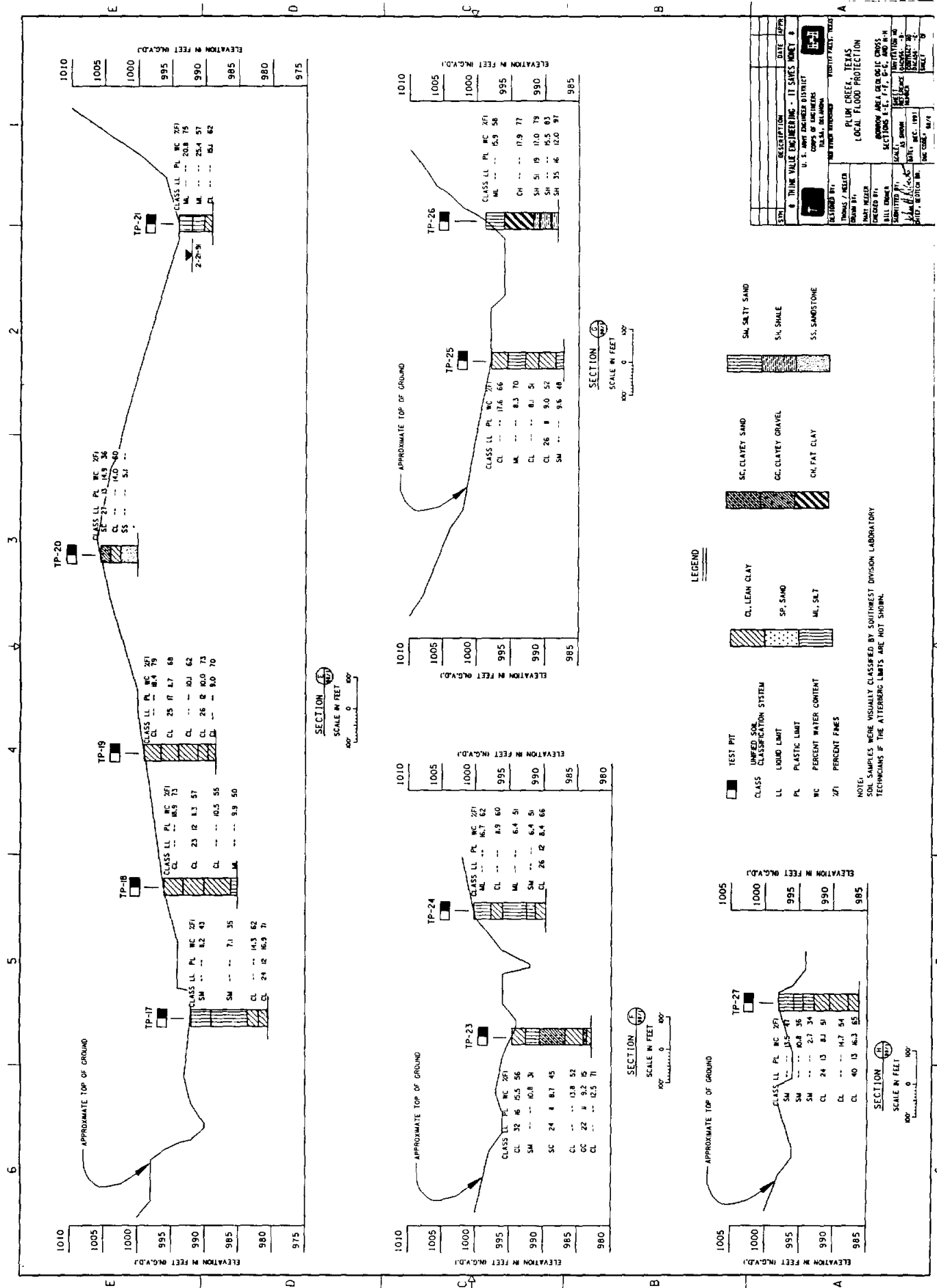

**LEGEND**

TEST PIT	UNIFIED SOIL CLASSIFICATION SYSTEM	CLASS	LL	PL	WC	ZFI
CL LEAN CLAY	CL	LEAN CLAY				
SP SAND	SP	SAND				
ML SILT	ML	SILT				
SC CLAYEY SAND	SC	CLAYEY SAND				
GC CLAYEY GRAVEL	GC	CLAYEY GRAVEL				
CH FAT CLAY	CH	FAT CLAY				
SM SALTY SAND	SM	SALTY SAND				
SH SHALE	SH	SHALE				
SS SANDSTONE	SS	SANDSTONE				

**DESCRIPTION**

U. S. ARMY ENGINEER DISTRICT  
 7  
 PLUM CREEK, TEXAS  
 LOCAL FLOOD PROTECTION  
 BORROW AREA GEOLOGIC CROSS-SECTION  
 SECTION E-E, F-F, G-G, AND H-H  
 SCALE: AS SHOWN  
 DATE: DEC. 1993  
 SHEET: 10 OF 10

NOTE:  
 SOIL SAMPLES WERE VISUALLY CLASSIFIED BY SOUTHWEST DIVISION LABORATORY  
 TECHNICIANS IF THE ATTENDING LIMITS ARE NOT SHOWN.

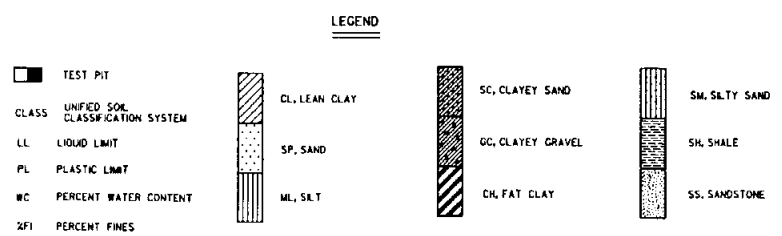
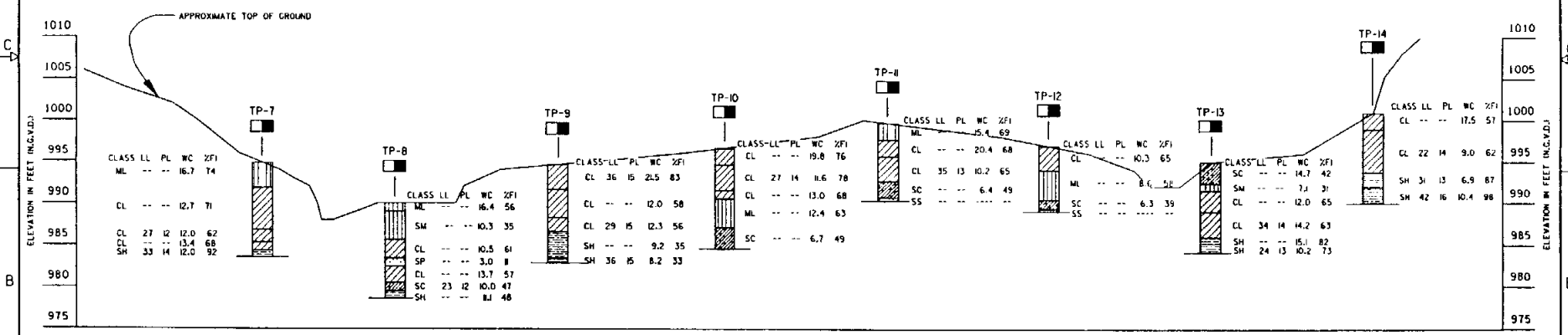
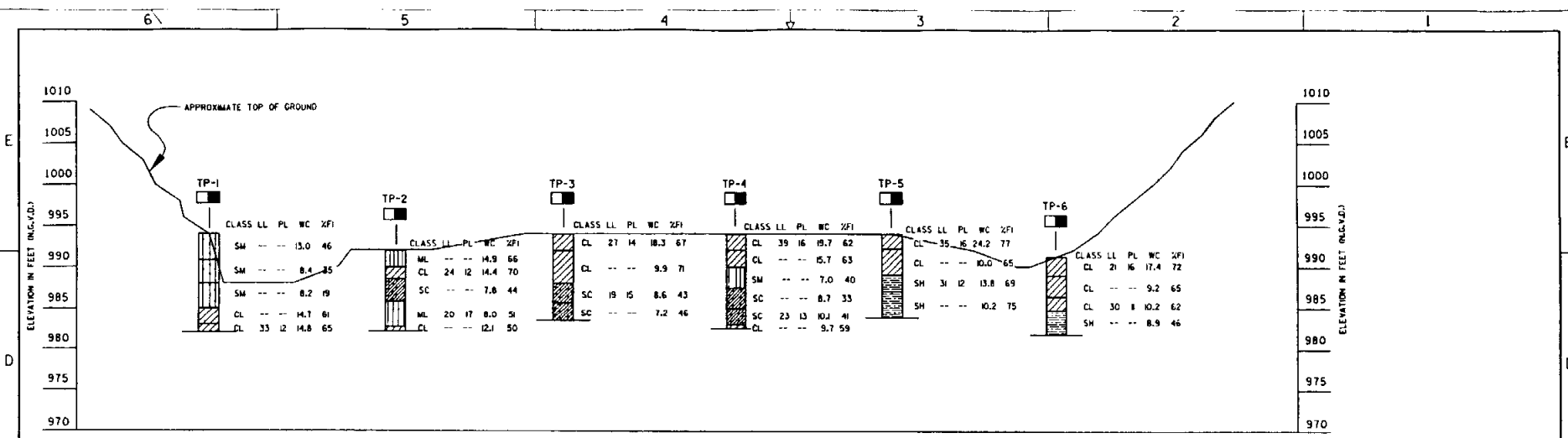

NOTE:  
SOIL SAMPLES WERE VISUALLY CLASSIFIED BY SOUTHWEST DIVISION LABORATORY TECHNICIANS IF THE ATTERBERG LIMITS ARE NOT SHOWN.

SYN	DESCRIPTION	DATE	APPR
	8 THINK VALUE ENGINEERING - IT SAVES MONEY 8		
	U. S. ARMY ENGINEER DISTRICT CORPS OF ENGINEERS TULSA, OKLAHOMA		
DESIGNED BY:	THOMAS / NECKER	DRAWN BY:	MARY NECKER
CHECKED BY:	BILL DROWER	SUBMITTED BY:	DATE: DEC. 1991
SCALE:	AS SHOWN	SHEET:	NO. 3
REFERENCE:		INVTATION NO:	
CONTRACT NO:		SHEET:	

PLUM CREEK, TEXAS  
LOCAL FLOOD PROTECTION  
BORROW AREA GEOLOGIC CROSS SECTIONS C-C AND D-D

6 5 4 3 2 1

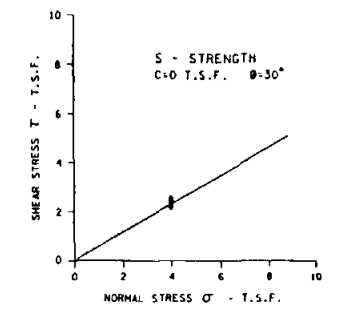
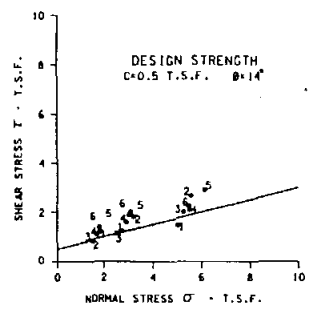
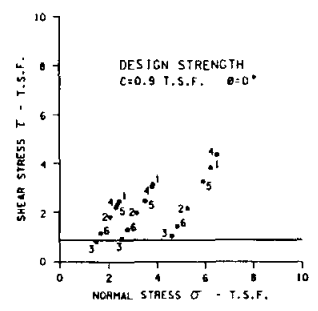

DESIGN Q - STRENGTHS - EMBANKMENT

DESIGN R - STRENGTHS - EMBANKMENT

DESIGN S - STRENGTHS - EMBANKMENT

EMBANKMENT MATERIAL - "Q"											
Sample	Hole No.	Depth	Classification	LL	PL	ZFI	$V_w$	$T_{max}$	% of Optimum	$C$	$\phi$
1	TP-4	1.9'-5.0'	CL	27	16	56	14.8	115.4	-2X	1.72	19.8
2	TP-4	1.9'-5.0'	CL	27	16	56	14.8	115.4	0	1.78	6.6
3	TP-4	1.9'-5.0'	CL	27	16	56	14.8	115.4	+2X	.82	4.6
4	TP-20	3.0'-5.0'	SH	MP	MP	36	13.2	117.6	-2X	1.22	25.8
5	TP-20	3.0'-5.0'	SH	MP	MP	36	13.2	117.6	0	1.62	16.7
6	TP-20	3.0'-5.0'	SH	MP	MP	36	13.2	117.6	+2X	1.16	5.5

EMBANKMENT MATERIAL - "R"											
Sample	Hole No.	Depth	Classification	LL	PL	ZFI	$V_w$	$T_{max}$	% of Optimum	$C$	$\phi$
1	TP-4	1.9'-5.0'	CL	27	16	56	14.8	115.4	-2X	1.13	5.7
2	TP-4	1.9'-5.0'	CL	27	16	56	14.8	115.4	0	.28	23.9
3	TP-4	1.9'-5.0'	CL	27	16	56	14.8	115.4	+2X	.40	17.6
4	TP-20	3.0'-5.0'	SH	MP	MP	36	13.2	117.6	-2X	.79	14.8
5	TP-20	3.0'-5.0'	SH	MP	MP	36	13.2	117.6	0	.91	15.1
6	TP-20	3.0'-5.0'	SH	MP	MP	36	13.2	117.6	+2X	.84	18.2

EMBANKMENT MATERIAL - "S"											
Sample	Hole No.	Depth	Classification	LL	PL	ZFI	$V_w$	$T_{max}$	% of Optimum	$C$	$\phi$
1	TP-4	1.9'-5.0'	CL	27	16	56	14.8	115.4	-2X	0	29.8
2	TP-4	1.9'-5.0'	CL	27	16	56	14.8	115.4	0	0	28.5
3	TP-4	1.9'-5.0'	CL	27	16	56	14.8	115.4	+2X	0	31.4
4	TP-20	3.0'-5.0'	SH	MP	MP	36	13.2	117.6	-2X	0	31.5
5	TP-20	3.0'-5.0'	SH	MP	MP	36	13.2	117.6	0	0	32.5
6	TP-20	3.0'-5.0'	SH	MP	MP	36	13.2	117.6	+2X	0	30.2

FOUNDATION MATERIAL - "Q"									
Sample	Hole No.	Depth	Classification	LL	PL	ZFI	$C$	$\phi$	$W_c$
1	PC-5 DB-1	2.0'-2.9'	CL	33	14	66	1.17	3.0	14.4
2	PC-5 DB-3	6.0'-8.0'	CL	27	13	79	1.91	4.5	18.0
3	PC-5 DB-5	10.0'-12.0'	CL	32	13	89	1.66	11.2	12.9
4	PC-8 DB-4	8.0'-10.0'	CL	26	14	51	.98	27.0	14.1

FOUNDATION MATERIAL - "R"									
Sample	Hole No.	Depth	Classification	LL	PL	ZFI	$C$	$\phi$	$W_c$
1	PC-5 DB-1	2.0'-2.9'	CL	33	14	66	.56	13.0	14.4
2	PC-5 DB-3	6.0'-8.0'	CL	27	13	79	.48	12.6	18.0
3	PC-8 DB-4	8.0'-10.0'	CL	26	14	51	.21	17.5	14.1

FOUNDATION MATERIAL - "S"									
Sample	Hole No.	Depth	Classification	LL	PL	ZFI	$C$	$\phi$	$W_c$
1	PC-5 DB-1	2.0'-2.9'	CL	33	14	66	0	25.6	19.3
2	PC-5 DB-3	6.0'-8.0'	CL	27	13	79	0	28.5	16.6
3	PC-8 DB-4	8.0'-10.0'	CL	27	16	56	0	29.1	13.7

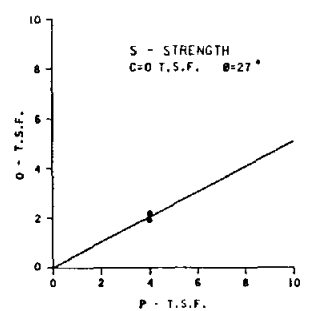
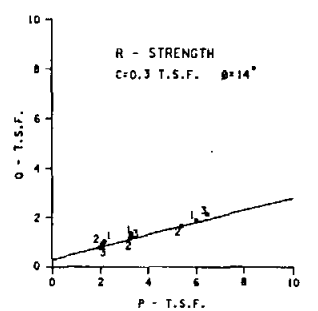
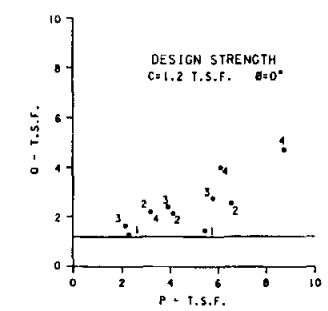

DESIGN Q - STRENGTHS - FOUNDATION

DESIGN R - STRENGTHS - FOUNDATION

DESIGN S - STRENGTHS - FOUNDATION

SYN	DESCRIPTION	DATE	APPN
THINK VALUE ENGINEERING - IT SAVES MONEY U. S. ARMY ENGINEER DISTRICT CORPS OF ENGINEERS TULSA, OKLAHOMA			
DESIGNED BY:	VICENTE PUBLICOS		
THOMAS / HEEGER	PLUM CREEK, TEXAS LOCAL FLOOD PROTECTION		
DRAWN BY:	MARY HEEGER		
CHECKED BY:	BILL DIMMER		
SUBMITTED BY:	SCALE:	AS SHOWN	SHEET NO.
DATE:	DATE:	DEC. 1991	NO. OF SHEETS
DATE:	DATE:	DEC. 1991	NO. OF SHEETS



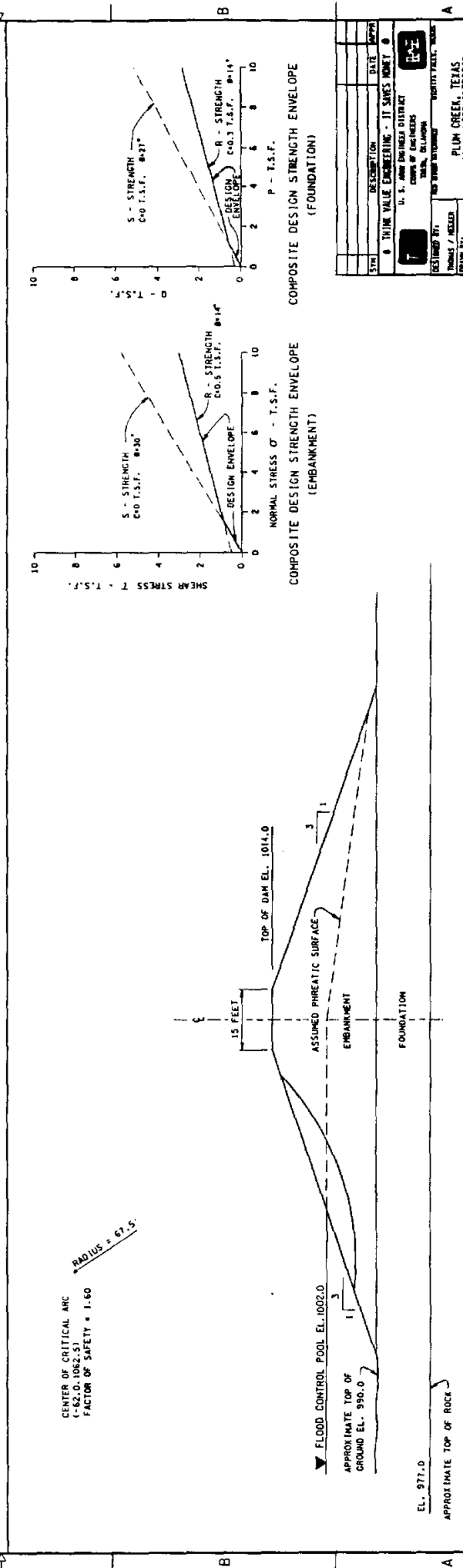
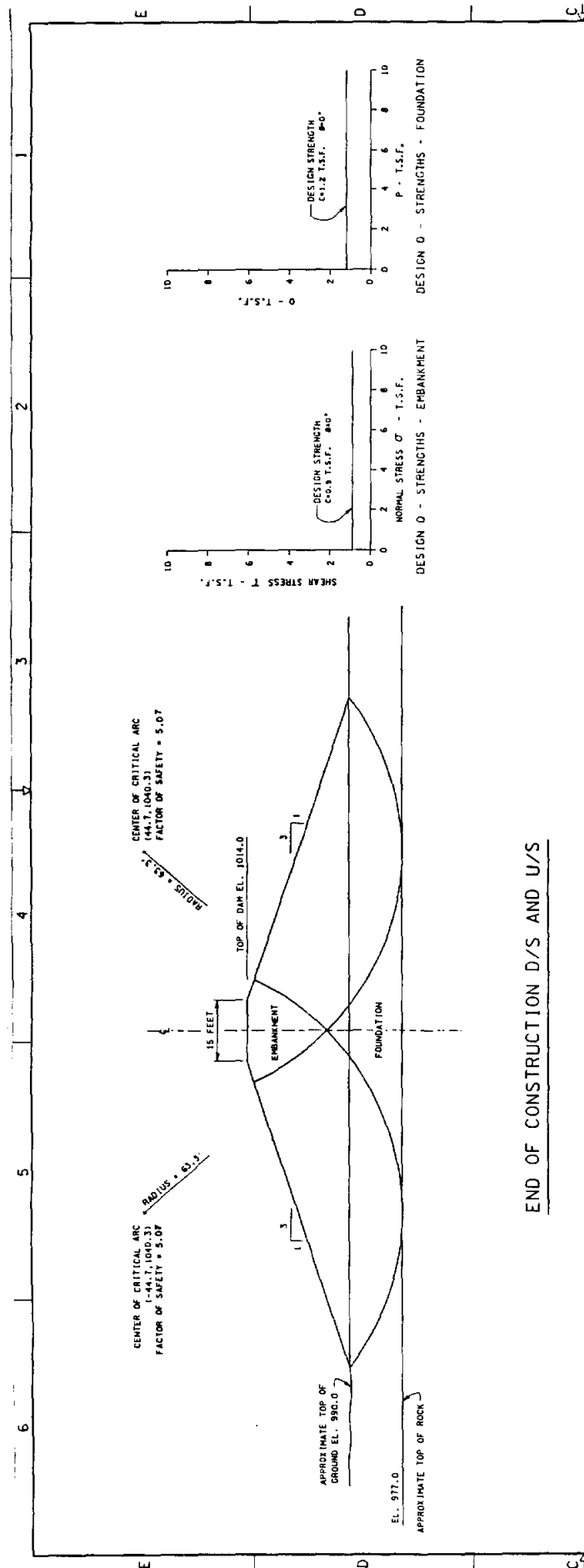

U.S. Army Engineer District  
 Fort Worth District  
 Fort Worth, Texas

PLUM CREEK, TEXAS  
 LOCAL FLOOD PROTECTION

QUALITY ANALYSIS - END OF CONSTRUCTION AND SUDDEN DRAWDOWN CASES  
 BILL NUMBER: 10000  
 SCALE: 1" = 20' HORIZONTAL, 1" = 10' VERTICAL  
 DATE: 11/11/81  
 DRAWN BY: [Signature]  
 CHECKED BY: [Signature]  
 DESIGNED BY: [Signature]

SHEET NO. 11 OF 11  
 PROJECT NO. 11-11-11

NOTE:  
 1. FOR SUDDEN DRAWDOWN ANALYSIS THE POOL HAS DRAINED DOWN FROM THE FLOOD CONTROL POOL ELEVATION TO THE APPROXIMATE TOP OF GROUND ELEVATION.

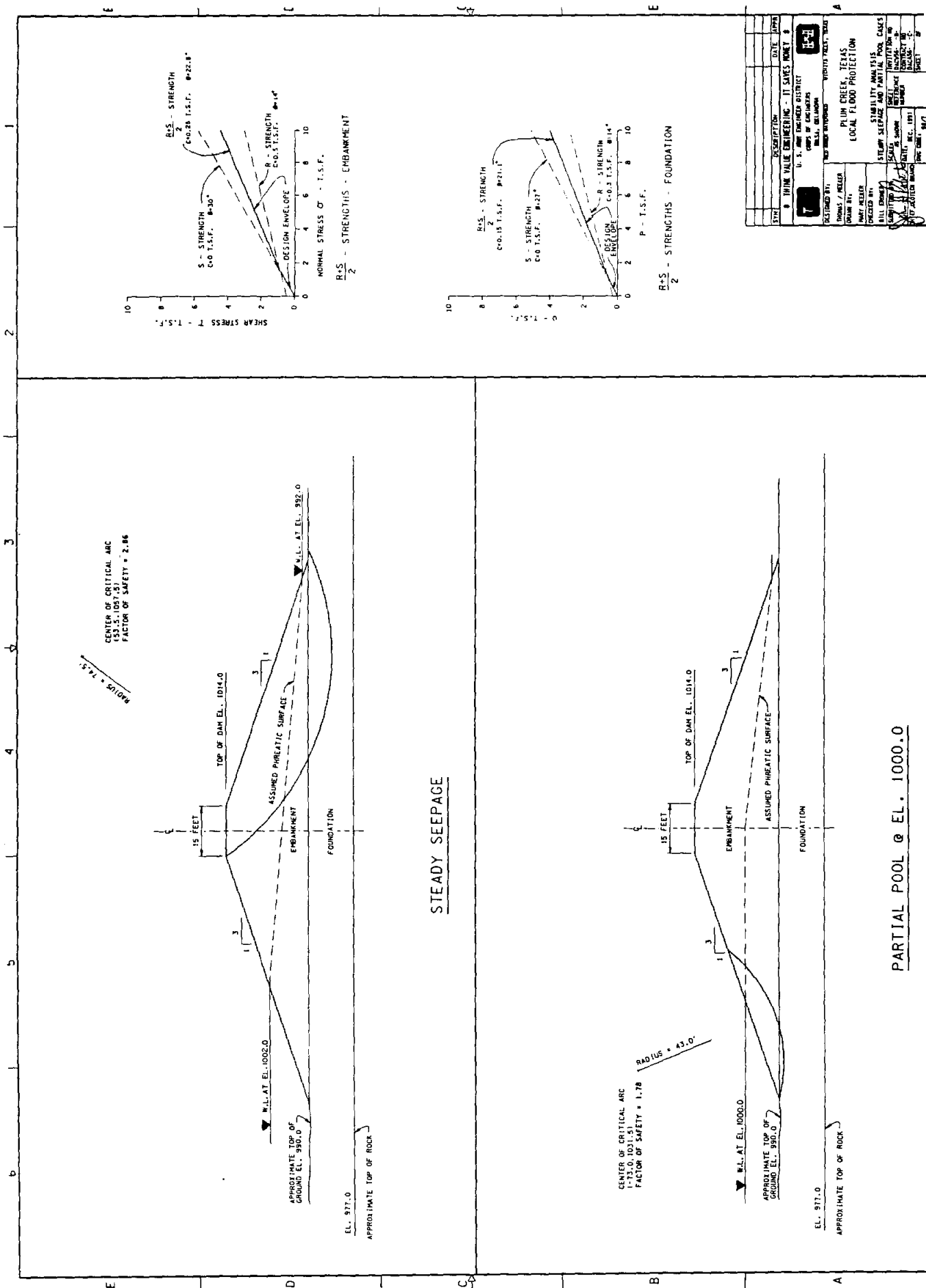

CENTER OF CRITICAL ARC  
 (S, S, 1007.51)  
 FACTOR OF SAFETY = 2.86

RADIUS = 24.5'

STEADY SEEPAGE

PARTIAL POOL @ EL. 1000.0

CENTER OF CRITICAL ARC  
 (S, S, 1001.51)  
 FACTOR OF SAFETY = 1.78

RADIUS = 43.0'

W.L. AT EL. 1000.0

EL. 977.0

APPROXIMATE TOP OF GROUND EL. 990.0

APPROXIMATE TOP OF ROCK

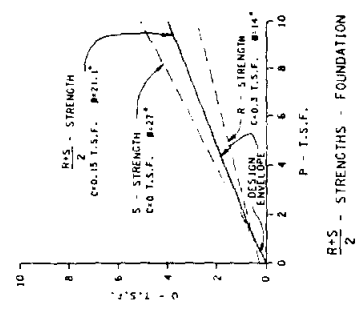
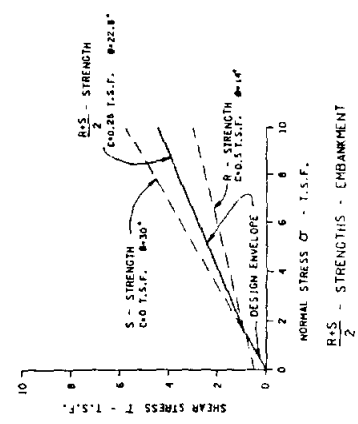
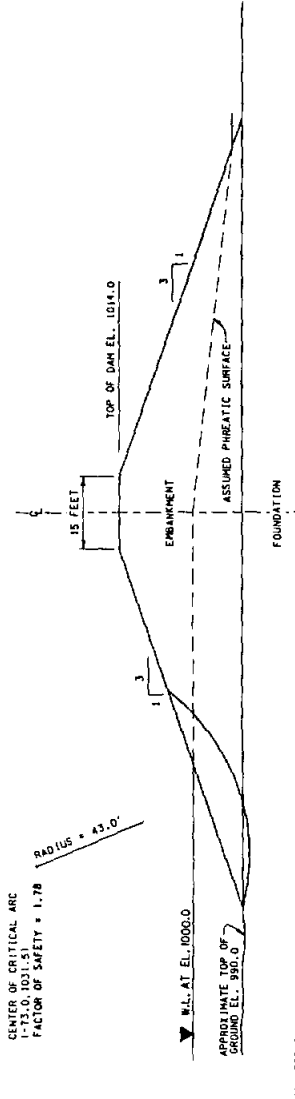
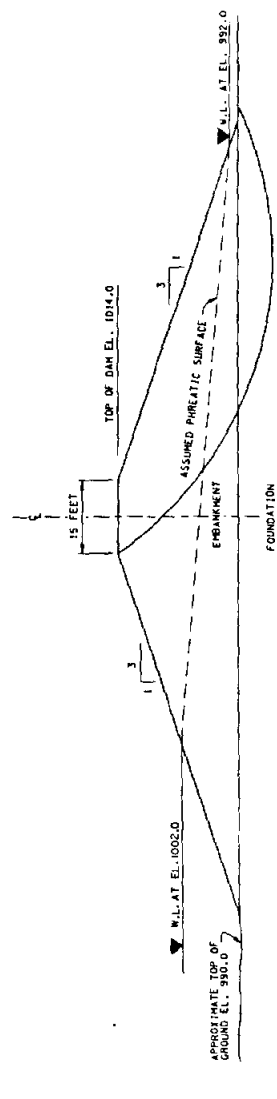

DATE	DESCRIPTION	DATE	BY
U. S. ARMY ENGINEER DISTRICT CORP. OF ENGINEERS WASH. DC. 20315			
PLUM CREEK, TEXAS LOCAL FLOOD PROTECTION			
STABILITY ANALYSIS STEADY SEEPAGE AND PARTIAL POOL CASES			
SCALE: AS SHOWN SHEET NO. 10 PROJECT NO. 1000.0			
DRAWN BY: [Signature] CHECKED BY: [Signature] BILL NUMBER: [Signature] APPROVED BY: [Signature]			
DATE: DEC. 1971 SHEET NO. 10 OF 10			

# APPENDIX 2 - ECONOMIC AND SOCIAL ANALYSIS

| | | | | | | | | | | | | | | | | | | | | |

APPENDIX 2

ECONOMIC AND SOCIAL ANALYSIS

TABLE OF CONTENTS

	<u>Page</u>
SOCIAL, ECONOMIC, AND INSTITUTIONAL ASSESSMENT	
Base Social and Economic Conditions . . . . .	2- 1
Population Characteristics . . . . .	2- 1
Economic Characteristics . . . . .	2- 2
Social Ecology . . . . .	2- 3
Institutional Conditions . . . . .	2- 3
Future Without-Project Conditions . . . . .	2- 4
Population Characteristics . . . . .	2- 4
Economic Conditions . . . . .	2- 5
Social Ecology . . . . .	2- 6
Institutional Conditions . . . . .	2- 6
Future With-Project Conditions . . . . .	2- 7
Population Characteristics . . . . .	2- 7
Economic Conditions . . . . .	2- 7
Social Ecology . . . . .	2- 7
Institutional Conditions . . . . .	2- 7
ECONOMIC BENEFIT EVALUATION	
Initial Economic Evaluation . . . . .	2- 8
National Economic Development (NED) Plan Selection . . . . .	2- 8
Final Economic Evaluation . . . . .	2- 8
Without-Project Conditions . . . . .	2-17
Flood History . . . . .	2-17
Floodplain Inventory . . . . .	2-17
With-Project Condition . . . . .	2-25
Benefit Evaluation . . . . .	2-25
Emergency Cost Benefits . . . . .	2-29
Flood Damage to Utilities . . . . .	2-30
Summary of Flood Control Benefits . . . . .	2-31

TABLE OF CONTENTS (Continued)

	<u>Page</u>
<u>Tables</u>	
2- 1	Historical Population Figures . . . . . 2- 1
2- 2	Number of Employed Persons, Wichita County, Texas: 1987 . . . . . 2- 3
2- 3	Projected Population of the Study Area, the City of Wichita Falls, and Wichita County (2000-2040) . 2- 5
2- 4	Projected Per Capita Income, Wichita County (2000-2040) . . . . . 2- 6
2- 5	Annual Benefits and Residual Losses, Preliminary Plans, Max. Pool = 1011, Top of Dam = 1014 . . . . 2- 9
2- 6	Annual Benefits and Residual Losses, Preliminary Plans, Max. Pool = 1012, Top of Dam = 1015 . . . . 2-11
2- 7	Annual Benefits and Residual Losses, Preliminary Plans, Max. Pool = 1013, Top of Dam = 1016 . . . . 2-13
2- 8	Annual Benefits and Residual Losses, Channel Plan . 2-15
2- 9	Example of the Marshall and Swift Depreciated Replacement Value Methodology . . . . . 2-18
2-10	Value of Properties by Structure and Content, Plum Creek SPF Floodplain . . . . . 2-19
2-11	Stage Versus Damage Relationship - Reach 7 . . . . . 2-21
2-12	Single-Occurrence Flood Losses, Existing Conditions 2-22
2-13	Average Annual Benefits and Residual Losses Detention Plan - Top of Dam at Elevation 1014 . . 2-23
2-14	Average Annual Damages - Reach 7 . . . . . 2-24
2-15	Average Annual Flood Losses, Existing Conditions . . 2-26
2-16	Average Annual Benefits, Selected Plan . . . . . 2-27
2-17	Average Annual Residual Losses, Selected Plan . . . 2-28
2-18	Emergency Expenditures, May 1982 Flood . . . . . 2-30
2-19	Average Annual Flood Control Benefits, Selected Plan 2-31

Figures

2- 1	Economic Reaches . . . . . 2-16
------	---------------------------------

## APPENDIX 2

### ECONOMIC AND SOCIAL ANALYSIS

This appendix provides the economic and social analyses conducted in conjunction with the evaluation of flood control measures along Plum Creek in Wichita Falls, Texas. The first section contains the social, economic, and institutional assessment. The second section contains the economic benefit evaluation.

#### SOCIAL, ECONOMIC, AND INSTITUTIONAL ASSESSMENT

The purpose of this section is to describe the social, economic, and institutional conditions of the population affected by the project alternatives under consideration. Those alternatives directly affect the population and economy of the city of Wichita Falls, located in Wichita County, Texas, and specific areas of the city, namely Census Tracts 129, 130, and 131. This area is referred to as the study area. The alternatives also involve the public institutions that serve the city.

#### BASE SOCIAL AND ECONOMIC CONDITIONS

##### Population Characteristics

Table 2-1 displays historical population figures for the study area, the city of Wichita Falls, and Wichita County.

TABLE 2-1

#### HISTORICAL POPULATION FIGURES

	Year			
	1960	1970	1980	1990
Study Area	4,884	7,604	7,628	8,300
City of Wichita Falls	101,724	96,371	94,201	96,259
Wichita County	129,638	126,322	121,082	122,378

Source: U.S. Bureau of Census decennial censuses, with the exception of the 1990 figure for the study area. The study area figure is an estimate based on city of Wichita Falls estimates cited in Growth Trends, March 1990, published by the city of Wichita Falls, Planning Department.

The populations of Wichita County and the city increased slightly between 1980 and 1990, reversing a trend of population decline that began in the 1970s. A major factor in that decline can be attributed to a decrease in military personnel at Sheppard Air Force Base during that period. The 1990 population of Wichita County is smaller than it was in 1960; however, the study area does not show a similar decline. The study area experienced considerable growth during the 1960s and has been relatively stable since then.

### **Economic Characteristics**

The primary industries in the county are services, agriculture, energy production, and light manufacturing. Ranching is the major agricultural activity. Manufacturing, service, financial services, and public administration industries are linked, both directly and indirectly, to agriculture and energy production. The public sector is also an important component of the local economy. Midwestern State University, with an enrollment of about 5,000, and Sheppard Air Force Base, which employs about 3,600 military and civilian personnel, are two of the largest employers in Wichita County.

Table 2-2 displays the 1987 accounting of employed individuals in Wichita County, by industry. The data in this table do not include self-employed persons and persons working in firms with fewer than 10 employees. This table provides an indication of the structure of the local economy and the relative importance of the various industries in terms of employment.

The single largest employing industrial category is government, which includes such activities as administrative, educational, military, and health care services. Services and retail trade are the next two largest industrial categories in terms of employment. Although petroleum exploration and production (mining category) do not directly employ a large percentage of persons in Wichita County, industries providing goods and services for petroleum production make up a substantial number of jobs in Wichita County.

The fluctuation in the energy economy has had an effect on all sectors of the city's economy as well as on the state of Texas. Historically, changes in the staffing of Sheppard Air Force Base have also had direct and indirect effects on employment in Wichita County. Despite slow economic growth, unemployment in Wichita County remains relatively low, ranging from 4.5 to 5% during the late 1980s. The 1988 per capita income for Wichita County was \$14,930 compared to the state figure of \$14,590.

TABLE 2-2

NUMBER OF EMPLOYED PERSONS\*  
WICHITA COUNTY, TEXAS: 1987

Industry	No. of Employees	Percent
Farm	669	1.15
Ag Services, Forestry, Fishing & Other	106	0.18
Mining	2,103	3.62
Contract Construction	1,762	3.03
Manufacturing	7,707	13.25
Transportation & other Public Utilities	2,383	4.10
Wholesale Trade	1,986	3.41
Retail Trade	10,913	18.76
Finance, Insurance, & Real Estate	2,256	3.88
Services	11,098	19.08
Government (BEA)	<u>17,184</u>	29.54
Total	58,167	

\* Does not include self-employed persons or persons working in firms with fewer than 10 employees.

Source: U.S. Army Construction Engineering Research Laboratory Economic Impact Forecasting System database based on U.S. Census, Bureau County Business Patterns, and Bureau of Economic Analysis data.

### Social Ecology

The study area within the city is primarily residential. Based on floodplain inventory data, approximately 650 persons live within the 100-year floodplain. Several major traffic routes cross the study area. Although the area is primarily residential, ten industrial and commercial businesses are also located there.

### Institutional Conditions

Based on the 1990 comprehensive annual financial report for the city, the 1990 total assessed valuation of property in the city was \$180 million. Bond indebtedness was \$45.2 million. This does not include indebtedness of counties, school districts, and other local government entities. The tax levy for the city is 0.6479 per \$100 assessed valuation. Indebtedness commitments are a factor in the city's ability to finance water resource projects. The Financial Capability Analysis (Appendix 7) describes the city's ability to finance a flood control project.



Local agencies recognized by Texas State Statutes as having jurisdiction and revenue-generating authority for water resources development are counties, municipalities, conservation districts, drainage districts, improvements districts, industrial districts, public wholesale water supply districts, and watershed districts.

These entities and their subordinate organizations have broad means of raising revenue. They may charge fees for goods and services, levee special assessment and other types of taxes, and issue bonds. Loans, grants, and gifts from Federal, State, local, and private agencies are also means of revenue generation. Although all these types of entities are not established in the county, they are institutional arrangements established by the State through which water resource projects could be financed.

Private sector and quasi-public entities are other institutional arrangements that could be utilized in the development of water resource projects. Those needing flood control protection may seek to develop water resources to meet their specific needs. Such private sector involvement in water resource development may require some innovative institutional arrangements.

## **FUTURE WITHOUT-PROJECT CONDITIONS**

### **Population Characteristics**

The socio-economic character of the county indicates that population change will be gradual over the next 50 years. Much of the growth in the study area and in Wichita County is contingent upon the status of Sheppard Air Force Base. Historically, changes in the role of the installation have had an effect on the number of people moving into or away from the metropolitan area in response to employment opportunities.

Out-migration and a negative natural increase (number of deaths minus births) could hamper future population growth in the city. These two factors are historical features of the area and are part of future population dynamics.

Table 2-3 displays population projections for the study area, the city of Wichita Falls, and Wichita County based upon 1985 OBERS projections. Based on these projections, the city is expected to continue a slow rate of growth through the year 2040, and Wichita County is expected to exceed 150,000 persons by the year 2040.

TABLE 2-3

PROJECTED POPULATION OF THE STUDY AREA,  
THE CITY OF WICHITA FALLS, AND WICHITA COUNTY  
(2000-2040)

	Year				
	2000	2010	2020	2030	2040
Study Area	9,300	10,000	10,400	10,700	11,000
City of Wichita Falls	104,600	110,300	114,400	117,000	119,600
Wichita County	132,300	139,100	144,100	147,200	150,400

Sources: 1990 Census of Population and Housing and the rate of change projected by the Bureau of Economic Analysis in the 1985 BEA Regional Projections, Vol. 1.; Washington, D.C.; U.S. Government Printing Office. City projections were developed using a shift share.

**Economic Conditions**

Along with population growth, economic growth is expected to increase at a gradual rate over time. However, the overall economic structure of the economy is not expected to change. The agricultural sector is expected to become less labor intensive, but the overall role of agriculture in the local economy will continue to be important. The characteristics of the population indicate that those persons in working age categories will decrease, resulting in lower labor force participation rates. According to OBERS 1985 projections, the labor force participation rate for income change is expected to fall from 55% in the year 2000 to 50% in the year 2040.

Table 2-4 displays the projected income for Wichita County. Income for both the state and county is expected to gradually increase over time with county income levels remaining below state income levels.

TABLE 2-4

PROJECTED PER CAPITA INCOME  
WICHITA COUNTY  
(2000-2040)

	Year				
	2000	2010	2020	2030	2040
Wichita County	16,100	17,000	20,200	24,400	28,300

Source: Projected figures based on rates of income change as reported by the Bureau of Economic Analysis in the 1985 BEA Regional Projections for Wichita County applied to the BEA per capita income estimate reported in Construction Engineering Research Laboratory Economic Impact Forecasting System (Vol. 1.; 1985: Washington, D.C.; U.S. Government Printing Office.

Under the without-project condition, flooding will continue to be a problem having short-term effects on the income of residents of Wichita County and of the city of Wichita Falls. City residents will continue to have to expend tax monies to repair flood-damaged property and to provide emergency services. Firms may be reluctant to expand or move into the county because of continued flooding, consequently affecting income and employment within the county. Flooding of firms will result in temporary loss of employment for those working in businesses located in the Plum Creek floodplain.

**Social Ecology**

Flooding will continue to threaten the quality of life of those living, working, and conducting business in the study area. Flooding in the most threatened areas is expected to continue to adversely affect the quality of life of those living, working, and doing business within that area. Based on the number of residents, there are approximately 650 persons living in areas threatened by a 100-year flood event.

**Institutional Conditions**

Local governments will continue to be faced with providing emergency services related to flooding. Tax revenues from flood-prone areas will be lower because of the lower property values.

## **FUTURE WITH-PROJECT CONDITIONS**

### **Population Characteristics**

Some population growth could be expected to occur in the study area if flood protection measures were in place. The resultant growth would enhance business and employment opportunities; however, with-project conditions are not expected to have a noticeable effect on population growth in Wichita County. Population growth in the study area may be greater than the without-project condition as the decrease in the risk of flooding makes the area a more desirable place to live. The population growth is expected to be similar to the without-project conditions.

### **Economic Conditions**

With-project conditions will reduce the cost of doing business in the city of Wichita Falls and will have an effect on income. Reduced flooding could provide a more conducive environment for business expansions and relocations and result in more employment opportunities. The reduced flooding would decrease the amount of temporary unemployment associated with flooding.

### **Social Ecology**

The overall health, safety, and quality of life of persons living in or conducting business in the study area would be enhanced by the flood protection provided with the project in place. Flood protection would only slightly decrease temporary unemployment resulting from flooded businesses. Although a decrease in unemployment will have an effect on income, the change is not considered significant when compared to the without-project condition. Construction activities will result in an increase in noise and in temporary disruptions to traffic. No families, businesses, or residences will be relocated as a result of the project.

### **Institutional Conditions**

Local governments will provide flood emergency services on a less frequent basis. Tax revenues from previously identified flood-prone areas will be increased somewhat because of an increase in the value of property. Since the local government would be required to cost share in the flood control project, this would place an additional demand on existing financial commitments.

## ECONOMIC BENEFIT EVALUATION

### INITIAL ECONOMIC EVALUATION

The initial economic evaluation of the flood control alternatives focused on a channel plan and three upstream dry detention reservoirs with maximum pool elevations of 1011, 1012, and 1013. Each maximum pool elevation was analyzed with an array of eight spillway sizes. Average annual benefits and residual losses were calculated for each maximum pool elevation and spillway size combination. The average annual benefits and residual losses were compared to show the effectiveness and efficiency of each detention alternative. Tables 2-5 through 2-7 outline the results of the preliminary economic analysis.

### NATIONAL ECONOMIC DEVELOPMENT (NED) PLAN SELECTION

In April 1991, preliminary average annual costs and benefits were compared for the detention reservoir alternatives under consideration. The detention reservoir with top of dam at elevation 1014 and a maximum pool elevation of 1011 had the greatest amount of net benefits. In addition, a detailed economic analysis based on current economic conditions was completed for a channel alternative. Net benefits for these two plans were compared, and the detention reservoir remained the plan with the greatest net benefits. Consequently, the detention reservoir was selected as the NED plan. Economic methodology for each plan was the same and is outlined in the following economic evaluation. Average annual flood reduction benefits and NED benefits were calculated as specified in the Economic and Environmental Principles and Guidelines for Water and Related Land Resources Implementation Studies. Table 2-8 shows the average annual benefits and residual losses for the channel alternative. The methodology for determining the other benefit categories for the channel plan is the same as discussed below for the selected plan.

### FINAL ECONOMIC EVALUATION

The following economic evaluation focuses on the NED plan. The analysis examined the area within the Standard Project Flood (SPF) floodplain along Plum Creek. (The SPF approximates the 500-year event.) The floodplain was divided into ten reaches as shown in Figure 2-1. Reaches were determined by considering:

1. The continuity of water surface profiles,
2. The homogeneity in the patterns of development in floodplain lands, and
3. The isolation of significant potential damage centers from areas of minimal or negligible damage potential.

TABLE 2-5

ANNUAL BENEFITS AND RESIDUAL LOSSES  
 PRELIMINARY PLANS  
 MAX. POOL = 1011, TOP OF DAM = 1014  
 (April 1991 Prices in \$1,000's)

Reach Number	Base Condition (Plan 1)	Expected Annual Damage							
		Plan 2		Plan 3		Plan 4		Plan 5	
		Damage w/Plan	Damage Reduced	Damage w/Plan	Damage Reduced	Damage w/Plan	Damage Reduced	Damage w/Plan	Damage Reduced
1	7.74	1.46	6.28	1.21	6.53	1.10	6.64	0.75	6.99
2	49.08	11.15	37.93	8.06	41.02	7.21	41.87	4.62	44.46
3	60.34	18.94	41.40	12.67	47.67	10.68	49.66	6.66	53.68
4	105.00	4.75	100.25	22.32	82.68	18.77	86.23	11.80	93.20
5	40.87	12.66	28.21	9.48	31.39	8.09	32.78	5.65	35.22
6	46.35	16.67	29.68	13.15	33.20	9.59	36.76	6.39	39.96
7	51.18	23.62	27.56	12.95	38.23	9.12	42.06	8.42	42.76
8	44.94	15.53	29.41	10.31	34.63	10.31	34.63	8.92	36.02
9	59.22	18.09	41.13	13.45	45.77	11.34	47.88	9.49	49.73
10	<u>25.35</u>	<u>14.62</u>	<u>10.73</u>	<u>13.20</u>	<u>12.15</u>	<u>13.96</u>	<u>11.39</u>	<u>22.70</u>	<u>2.65</u>
Total	490.07	137.49	352.58	116.80	373.27	100.17	389.90	85.40	404.67

2-9

- Plan 1 - Existing Condition  
 Plan 2 - Frequency of Spillway Operation = 2  
 Plan 3 - Frequency of Spillway Operation = 5  
 Plan 4 - Frequency of Spillway Operation = 10  
 Plan 5 - Frequency of Spillway Operation = 25  
 Plan 6 - Frequency of Spillway Operation = 50  
 Plan 7 - Frequency of Spillway Operation = 100  
 Plan 8 - Frequency of Spillway Operation = 200

TABLE 2-5 (Continued)

Reach Number	Base Condition (Plan 1)	Expected Annual Damage					
		Plan 6		Plan 7		Plan 8	
		Damage w/Plan	Damage Reduced	Damage w/Plan	Damage Reduced	Damage w/Plan	Damage Reduced
1	7.74	0.70	7.04	0.49	7.25	0.38	7.36
2	49.08	4.19	44.89	2.77	46.31	2.20	46.88
3	60.34	5.65	54.69	3.40	56.94	2.61	57.73
4	105.00	10.06	94.94	6.14	98.86	4.68	100.32
5	40.87	4.57	36.30	4.38	36.49	3.12	37.75
6	46.35	6.58	39.77	5.06	41.29	3.55	42.80
7	51.18	10.60	40.58	5.25	45.93	4.50	46.68
8	44.94	6.53	38.41	5.51	39.43	3.48	41.46
9	59.22	9.56	49.66	8.19	51.03	8.00	51.22
10	<u>25.35</u>	<u>14.82</u>	<u>10.53</u>	<u>23.51</u>	<u>1.84</u>	<u>23.78</u>	<u>1.57</u>
<b>Total</b>	<b>490.07</b>	<b>73.26</b>	<b>416.81</b>	<b>64.70</b>	<b>425.37</b>	<b>56.30</b>	<b>433.77</b>
Plan 1 - Existing Condition							
Plan 2 - Frequency of Spillway Operation = 2							
Plan 3 - Frequency of Spillway Operation = 5							
Plan 4 - Frequency of Spillway Operation = 10							
Plan 5 - Frequency of Spillway Operation = 25							
Plan 6 - Frequency of Spillway Operation = 50							
Plan 7 - Frequency of Spillway Operation = 100							
Plan 8 - Frequency of Spillway Operation = 200							

TABLE 2-6

ANNUAL BENEFITS AND RESIDUAL LOSSES  
 PRELIMINARY PLANS  
 MAX. POOL = 1012, TOP OF DAM = 1015  
 (April 1991 Prices in \$1,000's)

Reach Number	Base Condition (Plan 1)	Expected Annual Damage							
		Plan 2		Plan 3		Plan 4		Plan 5	
		Damage w/Plan	Damage Reduced	Damage w/Plan	Damage Reduced	Damage w/Plan	Damage Reduced	Damage w/Plan	Damage Reduced
1	7.74	1.18	6.56	1.10	6.64	0.86	6.88	0.70	7.04
2	49.08	8.07	41.01	7.38	41.70	6.17	42.91	4.27	44.81
3	60.34	13.17	47.17	11.48	48.86	9.63	50.71	6.01	54.33
4	105.00	23.07	81.93	20.28	84.72	16.65	88.35	10.68	94.32
5	40.87	11.15	29.72	8.35	32.52	6.21	34.66	4.93	35.94
6	46.35	12.97	33.38	10.87	35.48	6.61	39.74	7.79	38.56
7	51.18	13.76	37.42	10.36	40.82	12.12	39.06	6.20	44.98
8	44.94	10.73	34.21	10.13	34.81	8.84	36.10	8.31	36.63
9	59.22	14.91	44.31	14.15	45.07	10.67	48.55	9.43	49.79
10	<u>25.35</u>	<u>12.17</u>	<u>13.18</u>	<u>14.76</u>	<u>10.59</u>	<u>21.98</u>	<u>3.37</u>	<u>23.43</u>	<u>1.92</u>
<b>Total</b>	<b>490.07</b>	<b>121.18</b>	<b>368.89</b>	<b>108.86</b>	<b>381.21</b>	<b>99.74</b>	<b>390.33</b>	<b>81.75</b>	<b>408.32</b>

- Plan 1 - Existing Condition
- Plan 2 - Frequency of Spillway Operation = 2
- Plan 3 - Frequency of Spillway Operation = 5
- Plan 4 - Frequency of Spillway Operation = 10
- Plan 5 - Frequency of Spillway Operation = 25
- Plan 6 - Frequency of Spillway Operation = 50
- Plan 7 - Frequency of Spillway Operation = 100
- Plan 8 - Frequency of Spillway Operation = 200



TABLE 2-6 (Continued)

Reach Number	Base Condition (Plan 1)	Expected Annual Damage					
		Plan 6		Plan 7		Plan 8	
		Damage w/Plan	Damage Reduced	Damage w/Plan	Damage Reduced	Damage w/Plan	Damage Reduced
1	7.74	0.63	7.11	0.44	7.30	0.37	7.37
2	49.08	3.95	45.13	2.55	46.53	2.13	46.95
3	60.34	5.51	54.83	3.15	57.19	2.59	57.75
4	105.00	9.76	95.24	5.66	99.34	4.63	100.37
5	40.87	4.35	36.52	2.97	37.90	3.08	37.79
6	46.35	5.40	40.95	3.92	42.43	3.47	42.88
7	51.18	5.16	46.02	6.01	45.17	4.50	46.68
8	44.94	5.86	39.08	3.61	41.33	3.41	41.53
9	59.22	8.64	50.58	9.26	49.96	7.98	51.24
10	<u>25.35</u>	<u>23.39</u>	<u>1.96</u>	<u>24.21</u>	<u>1.14</u>	<u>23.92</u>	<u>1.43</u>
Total	490.07	72.65	417.42	61.78	428.29	56.08	433.99
Plan 1 - Existing Condition							
Plan 2 - Frequency of Spillway Operation = 2							
Plan 3 - Frequency of Spillway Operation = 5							
Plan 4 - Frequency of Spillway Operation = 10							
Plan 5 - Frequency of Spillway Operation = 25							
Plan 6 - Frequency of Spillway Operation = 50							
Plan 7 - Frequency of Spillway Operation = 100							
Plan 8 - Frequency of Spillway Operation = 200							

TABLE 2-7

ANNUAL BENEFITS AND RESIDUAL LOSSES  
 PRELIMINARY PLANS  
 MAX. POOL = 1013, TOP OF DAM = 1016  
 (April 1991 Prices in \$1,000's)

Reach Number	Base Condition (Plan 1)	Expected Annual Damage							
		Plan 2		Plan 3		Plan 4		Plan 5	
		Damage w/Plan	Damage Reduced	Damage w/Plan	Damage Reduced	Damage w/Plan	Damage Reduced	Damage w/Plan	Damage Reduced
1	7.74	0.93	6.81	0.71	7.03	0.68	7.06	0.65	7.09
2	49.08	6.71	42.37	5.02	44.06	4.42	44.66	3.98	45.10
3	60.34	10.66	49.68	8.22	52.12	6.83	53.51	5.62	54.72
4	105.00	18.69	86.31	14.21	90.79	12.01	92.99	9.95	95.05
5	40.87	5.95	34.92	5.79	35.08	5.35	35.52	4.47	36.40
6	46.35	6.82	39.53	8.39	37.96	7.93	38.42	6.49	39.86
7	51.18	15.18	36.00	9.80	41.38	7.75	43.43	5.44	45.74
8	44.94	8.40	36.54	7.96	36.98	7.93	37.01	6.01	38.93
9	59.22	11.47	47.75	10.08	49.14	9.59	49.63	8.84	50.38
10	<u>25.35</u>	<u>22.80</u>	<u>2.55</u>	<u>23.10</u>	<u>2.25</u>	<u>23.69</u>	<u>1.66</u>	<u>24.85</u>	<u>0.50</u>
Total	490.07	107.61	382.46	93.28	396.79	86.18	403.89	76.30	413.77

- Plan 1 - Existing Condition
- Plan 2 - Frequency of Spillway Operation = 2
- Plan 3 - Frequency of Spillway Operation = 5
- Plan 4 - Frequency of Spillway Operation = 10
- Plan 5 - Frequency of Spillway Operation = 25
- Plan 6 - Frequency of Spillway Operation = 50
- Plan 7 - Frequency of Spillway Operation = 100
- Plan 8 - Frequency of Spillway Operation = 200

TABLE 2-7 (Continued)

Reach Number	Base Condition (Plan 1)	Expected Annual Damage					
		Plan 6		Plan 7		Plan 8	
		Damage w/Plan	Damage Reduced	Damage w/Plan	Damage Reduced	Damage w/Plan	Damage Reduced
1	7.74	0.50	7.24	0.41	7.33	0.36	7.38
2	49.08	3.23	45.85	2.41	46.67	2.09	46.99
3	60.34	4.43	55.91	3.06	57.28	2.58	57.76
4	105.00	8.24	96.76	5.48	99.52	4.61	100.39
5	40.87	4.64	36.23	2.87	38.00	3.03	37.84
6	46.35	5.12	41.23	3.47	42.88	3.42	42.93
7	51.18	6.54	44.64	5.05	46.13	4.46	46.72
8	44.94	5.36	39.58	3.39	41.55	3.38	41.56
9	59.22	8.61	50.61	8.03	51.19	7.99	51.23
10	25.35	23.56	1.79	24.23	1.12	24.08	1.27
<b>Total</b>	<b>490.07</b>	<b>70.23</b>	<b>419.84</b>	<b>58.40</b>	<b>431.67</b>	<b>56.00</b>	<b>434.07</b>
Plan 1 - Existing Condition							
Plan 2 - Frequency of Spillway Operation = 2							
Plan 3 - Frequency of Spillway Operation = 5							
Plan 4 - Frequency of Spillway Operation = 10							
Plan 5 - Frequency of Spillway Operation = 25							
Plan 6 - Frequency of Spillway Operation = 50							
Plan 7 - Frequency of Spillway Operation = 100							
Plan 8 - Frequency of Spillway Operation = 200							

2-14

TABLE 2-8

ANNUAL BENEFITS AND RESIDUAL LOSSES  
CHANNEL PLAN  
(\$1,000)

Reach Number	Base Condition	<u>Expected Annual Damages</u>	
		Damage w/Plan	Damage Reduced
1	8.3	6.8	1.5
2	52.6	45.4	7.2
3	60.3	45.9	14.4
4	99.5	71.8	27.7
5	40.7	15.0	25.7
6	45.6	14.3	31.3
7	61.1	20.4	40.7
8	43.5	15.2	28.3
9	78.2	97.5	-19.3
10	<u>36.9</u>	<u>38.0</u>	<u>-1.1</u>
Total	526.7	370.3	156.4

Note: Negative numbers in Reaches 9 and 10 occurring from split flows in H&H model.

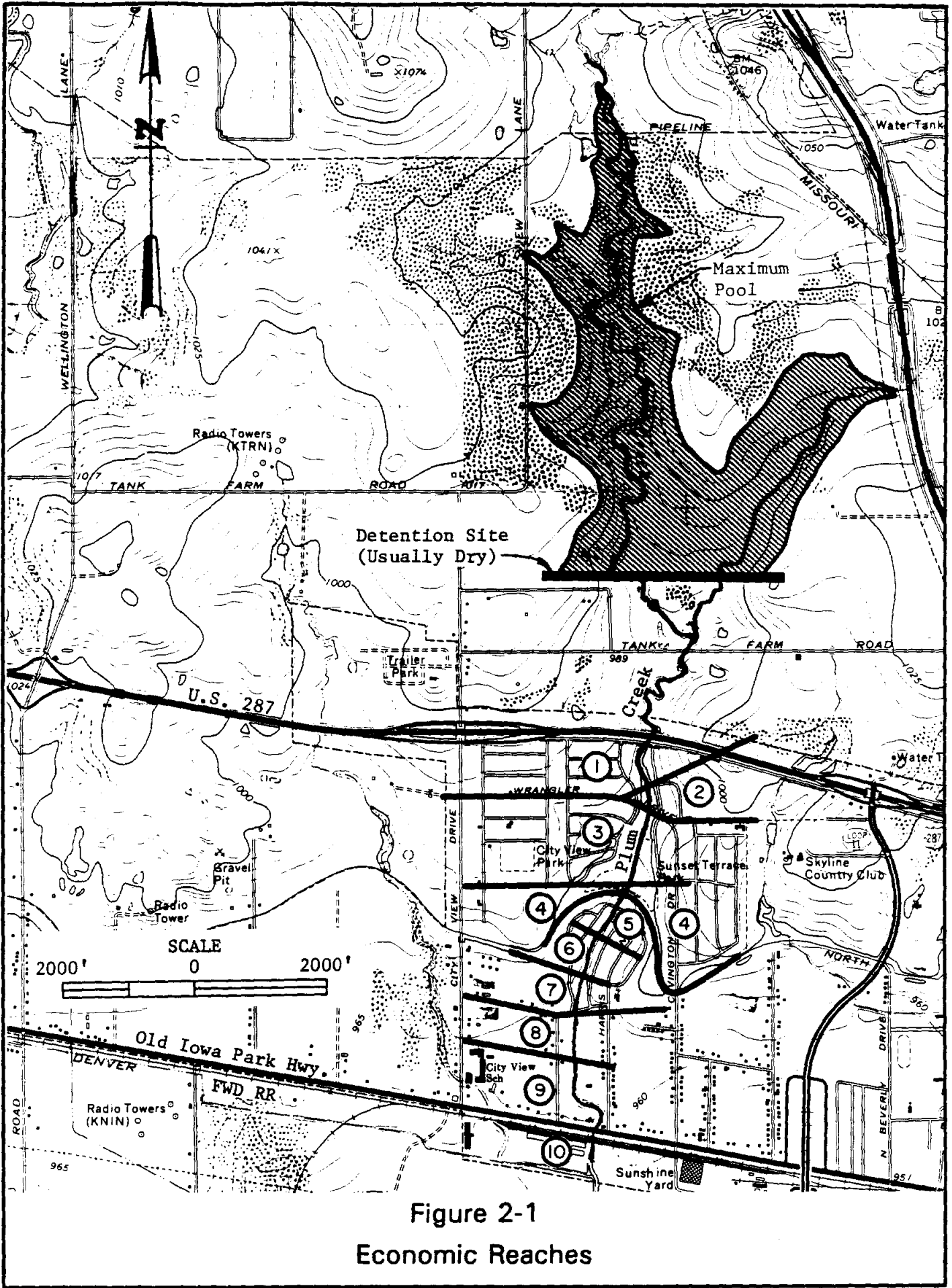

Figure 2-1  
Economic Reaches

## WITHOUT-PROJECT CONDITIONS

### Flood History

Major floods occurred along Plum Creek in 1940, 1941, 1955, and 1957. Lesser floods occur more frequently, averaging about one flood per year. The maximum flood of record occurred on October 29, 1941, and inundated 560 acres of urban and adjacent lands.

### Floodplain Inventory

Methodology. Topographic survey maps with contour intervals of 2 feet were used to determine base and floor elevations of all floodplain structures. The Wichita Falls Appraisal District provided detailed data about structures in the floodplain. The locations of the structures were identified by their parcel classification digits.

Property Valuations. The estimated depreciated replacement value of each structure in the floodplain was determined using procedures found in Marshall Valuation Service, published by Marshall and Swift. Using information from the Wichita County Appraiser's Office and the Marshall and Swift valuation method, the total cost of construction required to replace each structure was calculated. The replacement costs were calculated using square-foot construction costs for elements such as basements, floorings, walls, roofs, heating and air conditioning systems, plumbing, and garages. Table 2-9 is an example of the Marshall and Swift technique for calculating replacement value less depreciation for a typical residential structure in this floodplain.

TABLE 2-9

EXAMPLE OF THE MARSHALL AND SWIFT  
DEPRECIATED REPLACEMENT VALUE METHODOLOGY

Single-Family Residence                      Floor Area: 1,275 square feet  
Effective Age: 14 years                      Quality: Good                      Condition: Good

Style : One Story  
Heating and Cooling: Warmed and Cooled Air  
Exterior Wall : Common Brick  
Roofing : Composition Shingle  
Floor Structure : Wood Subfloor  
Floor Cover : Standard Allowance  
Plumbing : Standard Allowance  
Appliances : Standard Allowance  
Other Features : Single Fireplace

	<u>Units</u>	<u>Cost</u>	<u>Total</u>
Basic Structure Cost	1,275	\$55.17	\$70,316
Attached Garage	450	15.73	7,079
Replacement Cost New	1,275	60.70	77,393
Less Depreciation:			
Physical and Functional	<10.8% of cost>	to yield	<8,358>
Depreciated Cost	1,275	\$54.144	\$69,034

The value of residential contents was estimated to be 50% of the value of residential structures based on interviews with the Flood Insurance Administration and local insurance establishments. An examination of studies conducted by The Institute for Water Resources confirms that the 50% ratio is reasonable. The value of nonresidential structures in this study was calculated in two ways. In some instances, the values of commercial, public, semi-public, and industrial structures were comparable to Marshall and Swift values; therefore, the appraiser's depreciated replacement values could be used in the economic analysis. In other cases, the value of nonresidential structures was calculated using the Marshall Valuation Service's calculator cost form.

January 1992 values of properties within the SPF floodplain for the ten reaches, by structure and contents, are summarized in Table 2-10.

TABLE 2-10

VALUE OF PROPERTIES BY STRUCTURE AND CONTENT  
 PLUM CREEK SPF FLOODPLAIN  
 (\$1,000)

Reach	Residential			Commercial			Industrial			Public			Semi-Public			Total	
	(No)	(Value)	(Value)	(No)	(Value)	(Value)	(No)	(Value)	(Value)	(No)	(Value)	(Value)	(No)	(Value)	(Value)	(No)	(Value)
1	4	130	65	1	49	48	0	0	0	0	0	0	0	0	0	5	292
2	36	1,087	544	0	0	0	0	0	0	0	0	0	0	0	0	36	1,631
3	31	853	427	0	0	0	0	0	0	0	0	0	0	0	0	31	1,280
4	66	2,029	1,015	0	0	0	0	0	0	0	0	0	0	0	0	66	3,044
5	40	886	443	0	0	0	0	0	0	0	0	0	0	0	0	40	1,329
6	59	1,374	687	0	0	0	0	0	0	0	0	0	0	0	0	59	2,061
7	66	1,525	761	0	0	0	0	0	0	1	10	5	1	96	9	68	2,406
8	50	2,172	1,086	0	0	0	0	0	0	0	0	0	0	0	0	50	3,258
9	62	1,355	678	5	228	195	0	0	0	7	2,450	1,602	0	0	0	74	6,508
10	<u>0</u>	<u>0</u>	<u>0</u>	<u>2</u>	<u>584</u>	<u>701</u>	<u>2</u>	<u>1,870</u>	<u>1,115</u>	<u>0</u>	<u>0</u>	<u>0</u>	<u>0</u>	<u>0</u>	<u>0</u>	<u>4</u>	<u>4,270</u>
Total	414	11,411	5,706	8	861	944	2	1,870	1,115	8	2,460	1,607	1	96	9	433	26,079

2-19



Residential. Reaches 4 and 7 contain the largest number of residential properties. The SPF floodplain contains 414 residential properties. Residential structures in the Plum Creek floodplain are valued at \$11,411,000; the value of their contents is estimated to be \$5,706,000.

Commercial. Commercial properties in the Plum Creek floodplain are located in Reaches 1, 9, and 10. These structures consist of an auto repair shop, convenience/grocery stores, a pet shop, a restaurant, a machine shop, a heavy machinery warehouse, and lumber yards. The combined structural value is \$861,000, with contents valued at \$944,000.

Public. Public properties in this floodplain are public school properties and recreational facilities located in Reaches 7 and 9. These properties are valued at \$2,460,000; the value of their contents is estimated to be \$1,607,000.

Semi-Public. A church located in Reach 7 is the only semi-public structure, and it is valued at \$96,000 with contents worth \$9,000.

Industrial. A plastics firm and an industrial lumber facility in Reach 10 are the only industrial structures in the floodplain. Together, the structures are valued at \$1,870,000 with the contents (combined) valued at \$1,115,000.

Elevation-Damage Data. After the values of the structural inventory were tallied, elevation-damage curves were computed by applying the appropriate depth percent of damage relationships in one-foot increments to the values of the affected properties. Incremental damages to all properties comprising damage categories were summed to produce elevation-damage curves. The curves were developed in one-foot increments at the point of zero damages up to the SPF elevation. These calculations were performed using the Structure Inventory for Damage (SID) analysis computer program developed by the Hydrologic Engineering Center. To illustrate, Table 2-11 lists elevation-damage curve information for a representative reach.

TABLE 2-11

STAGE VERSUS DAMAGE RELATIONSHIP - REACH 7  
(\$1,000)

Eleva- tion	Res	Com	Pub	Sem	Ind	Res Con	Com Con	Pub Con	Sem Con	Total
960	.0	.0	.0	.0	.0	.0	.0	.0	.0	.0
963	.0	.0	.0	.0	.0	.0	.0	.0	.0	.0
964	.0	.0	.0	.0	.0	.0	.0	.0	.0	.0
965	4.6	.0	.0	.0	.0	1.8	.0	.0	.0	6.4
966	97.9	.0	.0	.5	.0	44.7	.0	.0	.9	144.0
967	230.8	.0	.0	9.6	.0	211.5	.0	.1	.9	452.9
968	346.2	.0	.0	10.6	.0	358.9	.0	1.3	2.5	719.5
969	438.8	.0	.0	10.6	.0	478.8	.0	2.5	4.7	935.4

Res = Residence

Com = Commercial

Pub = Public

Sem = Semi-public

Ind = Industrial

Rescon = Residential Contents

Comcon = Commercial Contents

Pubcon = Public Contents

Semcon = Semi-public Contents

Single-Occurrence Flood Losses. Table 2-12 outlines the estimated single-occurrence damages of the 1-, 2-, 5-, 10-, 25-, 50-, 100-, 200-year, and SPF events. Damages start at the elevation corresponding to the 5-year event in Reaches 2, 3, 4, 5, 6, 7, and 9. Damages start at the 10-year event in Reaches 1 and 8, and at the 25-year event in Reach 10. Potential single-occurrence damages range from \$388,500 for a 5-year event to \$9,092,700 for an SPF event. The single-occurrence damages are flood damages to structures and contents only.

TABLE 2-12

SINGLE-OCCURRENCE FLOOD LOSSES  
EXISTING CONDITIONS  
(\$1,000's)

Reaches	Flood Losses Per Flood Event								SPF
	1-Year	2-Year	5-Year	10-Year	25-Year	50-Year	100-Year	200-Year	
1	0.0	0.0	0.0	38.3	70.6	98.6	119.3	137.2	151.1
2	0.0	0.0	23.8	262.3	373.8	496.8	607.3	717.1	795.2
3	0.0	0.0	16.2	394.2	427.4	455.4	484.5	514.1	542.0
4	0.0	0.0	19.6	652.6	724.1	775.8	830.0	890.4	938.5
5	0.0	0.0	46.9	53.5	396.6	535.6	588.5	645.8	681.1
6	0.0	0.0	28.6	71.2	466.5	635.4	761.8	860.6	930.6
7	0.0	0.0	97.2	190.3	440.7	594.3	734.7	855.6	922.5
8	0.0	0.0	1.1	27.9	501.9	749.1	959.6	1,075.5	1,159.0
9	0.0	0.0	139.0	351.8	398.2	433.5	462.2	565.7	1,057.2
10	0.0	0.0	0.0	0.0	297.0	821.1	943.5	978.4	1,810.9
<b>Total</b>	0.0	0.0	372.4	2,042.1	4,096.8	5,595.6	6,491.4	7,240.4	8,988.1

Calculation of Average Annual Damages. Estimates of existing average annual damages were computed by combining the elevation-damage data relationship with the elevation-frequency relationship to establish a damage-frequency function. The Expected Annual Flood Damage (EAD) Computation computer program was used to estimate average annual losses under existing conditions based on January 1992 prices. The estimated average annual losses are \$532,300. Table 2-13 presents average annual flood loss estimates for existing conditions and the damages reduced (benefits) and residual damages (losses) for the plan with top of dam at elevation 1014.

TABLE 2-13

AVERAGE ANNUAL BENEFITS AND RESIDUAL LOSSES  
DETENTION PLAN - TOP OF DAM AT ELEVATION 1014  
(\$1,000)

Reach Number	Base Condition	Expected Annual Damages	
		Damage w/Plan	Damage Reduced
1	8.3	1.0	7.3
2	52.6	6.0	46.6
3	60.3	6.6	53.7
4	99.5	11.0	88.5
5	40.7	5.6	35.1
6	45.6	6.2	39.4
7	61.1	8.8	52.3
8	43.5	6.5	37.0
9	78.2	14.6	63.6
10	<u>36.9</u>	<u>10.3</u>	<u>26.6</u>
Total	526.7	76.6	450.1

Table 2-14 outlines the calculation of expected annual damages under existing conditions and with-project conditions for a representative reach, Reach 7.

TABLE 2-14

AVERAGE ANNUAL DAMAGES - REACH 7  
(\$1,000)

Frequency (percent)	Stage Elevation	Res	Pub	Sem	Ind	Rescon	Pubcon	Semcon	Indcon	Total
<u>Existing Conditions - Plum Creek Floodplain</u>										
100.00	960.65	.00	.00	.00	.00	.00	.00	.00	.00	.00
50.00	963.15	.00	.00	.00	.00	.00	.00	.00	.00	.00
20.00	965.66	66.15	.00	.32	.00	30.12	.00	.58	.00	97.17
10.00	966.15	117.84	.00	1.86	.00	69.73	.01	.88	.00	190.32
4.00	966.96	225.53	.00	9.28	.00	204.84	.06	.94	.00	440.65
2.00	967.53	292.01	.00	10.13	.00	289.62	.73	1.78	.00	594.27
1.00	968.07	352.73	.00	10.56	.00	367.27	1.40	2.69	.00	734.65
.50	968.63	404.55	.01	10.59	.00	434.43	2.06	3.92	.00	855.56
.20	968.94	433.24	.01	10.61	.00	471.61	2.43	4.60	.00	922.50
.01	970.00	519.42	.21	11.52	.00	547.24	2.56	6.11	.00	1,087.06
Exp Annual Damage		34.27	.00	.78	.00	25.72	.04	.25	.00	61.05
<u>NED Plan - Top of Dam = 1014; Maximum Pool = 1011, and Top of Flood Pool = 1002</u>										
100.00	960.46	.00	.00	.00	.00	.00	.00	.00	.00	.00
50.00	961.61	.00	.00	.00	.00	.00	.00	.00	.00	.00
20.00	962.42	.00	.00	.00	.00	.00	.00	.00	.00	.00
10.00	963.26	.00	.00	.00	.00	.00	.00	.00	.00	.00
4.00	964.62	2.83	.00	.00	.00	1.13	.00	.03	.00	3.99
2.00	965.88	86.69	.00	.42	.00	39.56	.00	.77	.00	127.44
1.00	966.44	156.39	.00	4.51	.00	118.10	.03	.90	.00	279.93
.50	967.46	283.93	.00	10.07	.00	279.30	.64	1.67	.00	575.61
.20	968.45	387.90	.00	10.58	.00	412.85	1.85	3.52	.00	816.70
.01	970.00	519.42	.21	11.52	.00	547.24	2.56	6.11	.00	1,087.06
Exp Annual Damage		4.74	.00	.10	.00	3.89	.01	.04	.00	8.79

2-24

## WITH-PROJECT CONDITION

### Benefit Evaluation

Flood damage reduction benefits were estimated by evaluating damages with and without the flood control project under existing hydrologic conditions in the basin. Average annual flood losses remaining with the project were deducted from existing condition flood losses to derive average annual flood damage reduction benefits.

Since no plan is 100% effective, residual flood damages are expected to occur with any plan. Table 2-15 shows the estimated average annual flood losses, by reach and damage category, for existing conditions. Table 2-16 displays the average annual flood damage reduction benefits, by reach and damage category, for the selected plan (Top of Dam = Elevation 1014, Maximum Pool = Elevation 1011, and Crest Elevation = Elevation 1002). Table 2-17 shows residual losses, by reach and damage category, for the selected plan.

TABLE 2-15

AVERAGE ANNUAL FLOOD LOSSES  
EXISTING CONDITIONS  
(\$1,000)

Property Classifications	Reaches										Total
	1	2	3	4	5	6	7	8	9	10	
Residential Structures	3.0	27.0	29.9	50.2	21.6	24.0	34.3	22.8	29.3	.0	242.1
Residential Contents	2.7	25.6	30.4	49.3	19.1	21.6	25.7	20.7	24.6	.0	219.7
Commercial Structures	1.1	.0	.0	.0	.0	.0	.0	.0	5.4	.6	7.1
Commercial Contents	1.5	.0	.0	.0	.0	.0	.0	.0	16.3	14.7	32.5
Public Structures	.0	.0	.0	.0	.0	.0	.0	.0	1.0	.0	1.0
Public Contents	.0	.0	.0	.0	.0	.0	.0	.0	1.6	.0	1.6
Semi-Public Structures	.0	.0	.0	.0	.0	.0	.8	.0	.0	.0	.8
Semi-Public Contents	.0	.0	.0	.0	.0	.0	.3	.0	.0	.0	.3
Industrial Structures	.0	.0	.0	.0	.0	.0	.0	.0	.0	9.9	9.9
Industrial Contents	.0	.0	.0	.0	.0	.0	.0	.0	.0	11.7	11.7
<b>Total</b>	<b>8.3</b>	<b>52.6</b>	<b>60.3</b>	<b>99.5</b>	<b>40.7</b>	<b>45.6</b>	<b>61.1</b>	<b>43.5</b>	<b>78.2</b>	<b>36.9</b>	<b>526.7</b>

TABLE 2-16

AVERAGE ANNUAL BENEFITS  
 SELECTED PLAN  
 (\$1,000)

Property Classifications	Reaches										Total
	1	2	3	4	5	6	7	8	9	10	
Residential Structures	2.7	23.9	26.6	44.6	18.6	20.8	29.5	19.5	24.3	.0	210.5
Residential Contents	2.3	22.7	27.1	43.9	16.5	18.6	21.8	17.5	20.7	.0	191.1
Commercial Structures	1.0	.0	.0	.0	.0	.0	.0	.0	4.1	.5	5.6
Commercial Contents	1.3	.0	.0	.0	.0	.0	.0	.0	12.3	10.6	24.2
Public Structures	.0	.0	.0	.0	.0	.0	.0	.0	.9	.0	.9
Public Contents	.0	.0	.0	.0	.0	.0	.0	.0	1.3	.0	1.3
Semi-Public Structures	.0	.0	.0	.0	.0	.0	.8	.0	.0	.0	.8
Semi-Public Contents	.0	.0	.0	.0	.0	.0	.2	.0	.0	.0	.2
Industrial Structures	.0	.0	.0	.0	.0	.0	.0	.0	.0	7.1	7.1
Industrial Contents	.0	.0	.0	.0	.0	.0	.0	.0	.0	8.4	8.4
<b>Total</b>	<b>7.3</b>	<b>46.6</b>	<b>53.7</b>	<b>88.5</b>	<b>35.1</b>	<b>39.4</b>	<b>52.3</b>	<b>37.0</b>	<b>63.6</b>	<b>26.6</b>	<b>450.1</b>



TABLE 2-17

AVERAGE ANNUAL RESIDUAL LOSSES  
SELECTED PLAN  
(\$1,000)

Property Classifications	Reaches										Total
	1	2	3	4	5	6	7	8	9	10	
Residential Structures	.4	3.0	3.3	5.6	3.0	3.2	4.7	3.3	5.0	.0	31.5
Residential Contents	.3	3.0	3.3	5.4	2.6	3.0	3.9	3.2	3.8	.0	28.5
Commercial Structures	.1	.0	.0	.0	.0	.0	.0	.0	1.3	.2	1.6
Commercial Contents	.2	.0	.0	.0	.0	.0	.0	.0	4.0	4.1	8.3
Public Structures	.0	.0	.0	.0	.0	.0	.0	.0	.2	.0	.2
Public Contents	.0	.0	.0	.0	.0	.0	.0	.0	.3	.0	.3
Semi-Public Structures	.0	.0	.0	.0	.0	.0	.1	.0	.0	.0	.1
Semi-Public Contents	.0	.0	.0	.0	.0	.0	.1	.0	.0	.0	.1
Industrial Structures	.0	.0	.0	.0	.0	.0	.0	.0	.0	2.8	2.8
Industrial Contents	.0	.0	.0	.0	.0	.0	.0	.0	.0	3.2	3.2
<b>Total</b>	<b>1.0</b>	<b>6.0</b>	<b>6.6</b>	<b>11.0</b>	<b>5.6</b>	<b>6.2</b>	<b>8.8</b>	<b>6.5</b>	<b>14.6</b>	<b>10.3</b>	<b>76.6</b>

## Emergency Cost Benefits

Flood events create a need to provide emergency services to victims. The cost of those services is paid by Federal, State, local, and private entities. The reduction in flooding provided by an alternative results in a reduction of the costs associated with delivering emergency services. The reduction in emergency services costs can be accrued to the NED benefits.

During the May 1982 flood, which was centered on Holliday and McGrath Creeks, it was estimated that \$1,623,000 was spent providing emergency services to flood victims in Wichita Falls. Those emergency services included food, temporary housing, unemployment assistance, and other forms of assistance. The cost of the emergency services provided during the May 1982 flood is \$2,222,100 in 1991 dollars. (This figure does not include some unaccounted for emergency expenditures.) The data on expenditures for emergency services during the 1982 flood in Wichita Falls were used to estimate potential emergency expenditures in the Plum Creek floodplain.

Data from the 1982 flood were used to calculate the amount of emergency costs that would be reduced by the selected flood control plan under consideration. Disaster assistance is linked to whether flood waters enter victims' homes. Consequently, the estimated emergency costs associated with the selected alternative are based on the number of structures that are flooded under specific flood events.

Table 2-18 displays the number of households flooded in 1982, the types of services received, the number of victims receiving services, and the amount of money spent on each type of service. The expenditures were updated to January 1992 costs. The last column of the table is the cost of providing emergency services for all flooded houses.

TABLE 2-18

EMERGENCY EXPENDITURES  
MAY 1982 FLOOD  
(January 1992 Costs)

	No. of Houses Flooded	No. of Victims Assisted	Percentage of total Victims Receiving Assistance	Money Spent	Money Spent Per Victim	Money Spent Per All House- holds
Red Cross	1,830	605	33.1	624,491	1,032	341
FEMA-Temporary Housing	1,830	340	18.6	98,493	290	54
Department of Human Services	1,830	304	16.6	1,263,476	4,156	690
Department of Labor	1,830	25	1.4	16,440	658	9
City of Wichita Falls	1,830			219,200		120
Total						1,214

Source: U.S. Army Corps of Engineers, Tulsa District flood damage assessment data.

The estimated value per household flooded for providing these emergency services is \$1,214. This figure is multiplied by the estimated number of structures flooded for each flood event. For example, if ten structures are flooded in the 10-year event, the emergency cost value is estimated to be \$12,140. This computation is made for each flood event interval to obtain a stage-damage relationship. The stage-damage curve is integrated to obtain the average annual equivalent for emergency cost. The NED plan would prevent \$43,900 in emergency costs annually.

#### Flood Damage to Utilities

Post-flood studies conducted in June 1979 have shown that damages to utilities, including electric and telephone transmission systems and water and gas services pipelines, occur as a result of flooding. Information on damages to utilities comes from city and county governments and from various utility companies. In 1979, utility damages averaged about \$77 per structure in the floodplain. Updated to January 1992 price levels, utility damages were about \$123 per structure. Stage-damage relationships were based on this value. The average annual benefit of reducing flood damages to utilities for the NED Plan was estimated at \$4,500.

## Summary of Flood Control Benefits

Table 2-19 summarizes the flood control benefits for the selected plan.

TABLE 2-19

AVERAGE ANNUAL FLOOD CONTROL BENEFITS  
SELECTED PLAN  
(\$1,000)

Category	Benefits
Inundation	450.1
Emergency	43.9
Utilities	<u>4.5</u>
Total	498.5

# APPENDIX 3 - REAL ESTATE SUPPLEMENT

1  
2  
3  
4  
5  
6  
7  
8  
9  
10  
11  
12  
13  
14  
15  
16  
17  
18  
19  
20  
21  
22  
23  
24  
25  
26  
27  
28  
29  
30  
31  
32  
33  
34  
35  
36  
37  
38  
39  
40  
41  
42  
43  
44  
45  
46  
47  
48  
49  
50

### APPENDIX 3

#### REAL ESTATE SUPPLEMENT

This supplement addresses the real estate requirements for the Plum Creek local flood protection feasibility study in Wichita Falls, Texas. The reconnaissance report was approved in February 1989 by the Commander, Southwestern Division. The selected plan consists of a dry detention area, earthen dam, and emergency spillway. A concrete-lined drainage channel with a 10-foot bottom width will connect the two arms of Plum Creek just north of the embankment. The plan will also require the construction of an access road leading to the project area.

The proposed project is located north and west of the city limits of Wichita Falls, and just northwest of the intersection of U.S. Highway 281 (Interstate 44) and U.S. Highway 287. The immediate vicinity of the project is undeveloped low-lying land. Current land use is for livestock pasture. Vegetative cover consists of grasses with scattered mesquite and wild plum thicket. Plum Creek is an intermittent, seasonal stream which flows south through the project area. The area where the access road is to be located is level, dry cropland.

The project will require the acquisition of 76.4 acres in fee. Of the total fee acquisition, 52.4 acres are needed for the damsite, drainage channel, and spillway, and 24 acres are needed for a wildlife mitigation area.

Approximately 306 acres of flowage easement will be required over lands up to elevation 1011 National Geodetic Vertical Datum (NGVD) for the detention area. An additional flowage area consisting of about 7.8 acres will be needed immediately downstream of the spillway to allow for potential discharge.

A borrow easement estate will be required over approximately 51.5 acres of the detention area where excavated material will be obtained for construction of the embankment.

An access road requiring 1.3 acres of perpetual road easement is proposed to connect the project to public roads. The access road will extend from the west end of the damsite area to the southeast corner of the intersection of Tank Farm Road and City View Lane on the west side of the project.

Temporary work area easements may be required for the project; however, none have been identified at this time.

No additional lands will be required for the relocation of utilities or facilities.

A summary of the acreage and estates needed for the project is as follows:

Fee for damsite, spillway, and drainage channel -  
52.4 acres

Fee for wildlife mitigation - 24 acres

Flowage Easement for detention area and below  
spillway - 262.5 acres

Flowage/Borrow Easement for detention and borrow  
area - 51.5 acres

Perpetual Road Easement for access road - 1.3 acres

The general area of the project has some potential for oil and gas development. The value of minerals has been determined and is included in the fee value cited in this report. It is recommended that mineral rights in easement areas be subordinated to the prior right of the Government to regulate their development. The value of mineral subordination is included in the easement values cited in this report.

There is no Federally-owned land in the vicinity suitable for project construction. No lands which were acquired with Federal funds are involved in the project.

The local sponsor has no ownership interest in any of the lands proposed for the project.

Approximately 16 ownerships will be affected by the project; however, no residences, farms, or businesses will be displaced. No relocation costs related to Public Law 91-646 are anticipated.

The local sponsor has previously engaged in cost-sharing local flood control projects with the Government. Past performance shows the sponsor to be knowledgeable and competent in land acquisition. The local sponsor has the ability to acquire land by right of eminent domain, should it be necessary.

There is no known opposition among landowners concerning the project.

Land values for this report are based on a gross appraisal dated September 3, 1991, prepared by Mr. Dan L. Wigington, MAI, of Lawton, Oklahoma. Mineral values are based on a gross mineral appraisal prepared by the Tulsa District Office appraisal staff and dated August 1991.

REAL ESTATE COST ESTIMATE SUMMARY

01	Lands and Damages	<u>Non-Fed</u>	<u>Fed</u>
M.3	Fee - Damsite, spillway, drainage channel, 52.4 acres	\$ 19,126	\$ 0
M.3	Fee - Mitigation, 24 acres	\$ 8,760	\$ 0
M.3	Road Easement, 1.3 acres	\$ 650	\$ 0
M.3	Flowage Easement, 262.5 acres	\$ 77,175	\$ 0
M.3	Flowage/Borrow Easement, 51.5 acres	\$ 16,738	\$ 0
M.3	Temporary Work Area Easement, ----	\$ -----	\$ 0
M.3	Improvements	\$ 0	\$ 0
M.3	Severance	\$ 23,319	\$ 0
M.4	Relocation Assistance	\$ 0	\$ 0
	Subtotal	\$145,768	\$ 0
D.1	Administrative	\$ 83,200	\$28,800
M.8	Contingencies	\$ 57,244	\$ 7,200
	Subtotal	<u>\$286,212</u>	<u>\$36,000</u>
	TOTAL LANDS AND DAMAGES	\$322,212	
		(R) \$323,000	



# APPENDIX 4 - GEOLOGY AND SOILS

**APPENDIX 4**  
**GEOLOGY AND SOILS**

**TABLE OF CONTENTS**

	<b><u>Page</u></b>
GENERAL . . . . .	4- 1
GENERAL GEOLOGY AND TOPOGRAPHY . . . . .	4- 1
Physiography and Topography . . . . .	4- 1
Stratigraphy . . . . .	4- 1
FOUNDATION . . . . .	4- 2
General . . . . .	4- 2
Overburden . . . . .	4- 2
Bedrock . . . . .	4- 2
Explorations . . . . .	4- 3
Laboratory Tests . . . . .	4- 3
Seepage Control . . . . .	4- 4
Settlement . . . . .	4- 4
EMBANKMENT MATERIALS . . . . .	4- 4
Required Excavation . . . . .	4- 4
Borrow Explorations and Tests . . . . .	4- 5
Description of Borrow Materials . . . . .	4- 6
EMBANKMENT DESIGN . . . . .	4- 6
General . . . . .	4- 6
Typical Sections . . . . .	4- 6
Embankment Stability . . . . .	4- 6
Seepage Controls . . . . .	4- 7
Protection Stone . . . . .	4- 8
Seismic Design . . . . .	4- 9
SPELLWAY SLOPE PROTECTION . . . . .	4- 9
CONSTRUCTION CONSIDERATIONS . . . . .	4- 9
Outlet Structure Foundation . . . . .	4- 9
Channel Cleanup . . . . .	4- 9
Embankment Placement Controls . . . . .	4-10
AVAILABILITY OF CONSTRUCTION MATERIALS . . . . .	4-10
Borrow . . . . .	4-10
Required Excavation . . . . .	4-10
Filter Sand . . . . .	4-10
Protection Stone . . . . .	4-10

TABLE OF CONTENTS (Continued)

	<u>Page</u>
<u>Tables</u>	
4-1 Summary of Foundation Materials . . . . .	4- 4
4-2 Summary of Borrow Area Soils . . . . .	4- 5
4-3 Embankment and Foundation Design Strengths . . . . .	4- 7
4-4 Safety Factors . . . . .	4- 7

List of Drawings

98/1 Plan of Exploration and Geologic Sections A-A and B-B . . . . .	4-11
98/2 Profile Along Dam Axis . . . . .	4-12
98/3 Borrow Area Geologic Cross Sections C-C and D-D . . . . .	4-13
98/4 Borrow Area Geologic Cross Sections E-E, F-F, G-G, and H-H . . . . .	4-14
98/5 Embankment and Foundation Design Strengths . . . . .	4-15
98/6 Stability Analysis - End of Construction and Sudden Drawdown Cases . . . . .	4-16
98/7 Stability Analysis - Steady Seepage and Partial Pool Cases . . . . .	4-17

Appendices

A Geologic Logs	
B SWDED-GL Report No. 15296 - Foundation Material	
C SWDED-GL Report No. 15299 - Borrow Material	

## APPENDIX 4

### GEOLOGY AND SOILS

#### GENERAL

The geology, geotechnical investigations, and design of the dam are discussed in this section. The flood control structure will be located on Plum Creek, which is northwest of the downtown area of Wichita Falls, Texas. The embankment location is shown in plan on Drawing 98/1. The drainage area above the damsite is approximately 4.08 square miles, with a maximum local relief of approximately 45 feet. Field exploration and laboratory testing programs were developed to satisfy design requirements.

#### GENERAL GEOLOGY AND TOPOGRAPHY

##### Physiography and Topography

The Plum Creek area northwest of the intersection of Interstate 44 and U.S. Highway 287 near Wichita Falls is located in the Red Bed Plains division of the Central Lowlands Physiographic Province. This section of the province is characterized by gentle, low rolling hills sometimes separated by large, flat areas of little relief. Surface water runoff exits from the south and enters Plum Creek. Plum Creek eventually enters the Wichita River west of Wichita Falls.

##### Stratigraphy

The Plum Creek area is underlain by residuum and bedrock of the Permian-aged Petrolia Formation of the Paleozoic era, which exceeds 350 feet in thickness. Near the end of the late Paleozoic era, the epicontinental seas gradually withdrew, and evaporite and red bed sequences developed in the Permian basins of New Mexico and west Texas. The Petrolia Formation (formerly the Wichita Group) consists chiefly of reddish-brown shale and mudstone with lesser amounts of sandstone, conglomerate, and limestone. The shale and mudstone consists of crudely stratified silts and clays commonly with calcareous nodules and occasional plant and animal fossils. Sandstone occurs as red to yellowish-brown, thinly-bedded layers and thicker sequences representing channel fill deposits. Sandstone members range in thickness from 3 to 25 feet and generally occupy topographically high areas of the otherwise gently rolling terrain. The Petrolia Formation is typical of other Permian-aged deltaic deposits found elsewhere in north-central Texas, since the depositional environment consists of a complex array of fluvial, lagoonal, and floodplain deposits. The resultant stratigraphy consists of discontinuous sands interbedded with extensive deposits of silt and clay.

## FOUNDATION

### General

The embankment is approximately 3,100 feet in length with a maximum height of 28.8 feet above the Plum Creek channel and an average height of 25 feet across the floodplain. The terrain at the right abutment slopes gently on average slope of about 1 vertical (V) to 40 horizontal (H) from the beginning of the embankment until intersecting the floodplain at about station 16+00. The terrain at the left abutment also slopes gently on average slope of about 1V to 20H from the beginning of the embankment until intersecting the floodplain at approximately station 34+00. The floodplain is relatively flat.

### Overburden

Overburden at the site ranges in thickness from 1.0 feet in holes no. PT-11 and PT-12 (located in the left abutment spillway) to 15.5 feet in hole no. PT-6 (located near the mid-point of the valley section). The foundation soil at the site is primarily a lean clay. However, lenses of a clayey sand are encountered in borings no. PT-2, PT-3, PT-4, PT-6, PT-13, and PT-15. These lenses range in thickness from approximately 1 foot to 8 feet. A foundation profile showing the soil classification information, approximate water table elevations, and approximate top of rock are shown on Drawings 98/1 and 98/2.

**Floodplain.** The depth of the overburden across the floodplain ranges from 8.1 to 15.5 feet. The foundation soils are, as mentioned previously, mostly lean clays. Lenses of a clayey sand are present in only two borings within the floodplain, PT-4 and PT-6. The water table within the floodplain was encountered at an average depth of 21.5 feet.

**Abutments.** The left abutment rises at an average slope of about 1V to 20H to a height of approximately 35 feet above the floodplain. The overburden on the left abutment consists of a 1- to 3-foot layer of lean clay. The right abutment rises on an average slope of about 1V to 40H. The overburden at the right abutment consists of clayey sand and lean clay with a thickness of approximately 5 feet.

### Bedrock

The bedrock beneath the entire site consists of interbedded sandstone and shale. The sandstone is primarily poorly cemented and fine grained with occasional shale bedding seams. The shale is reddish-brown and primarily soft, with occasional silty and limestone pockets scattered throughout. Bedrock in the left abutment and spillway consists of a poorly cemented fine sandstone underlain by shale. Bedrock in the right abutment is a soft shale.

A detailed description of the foundation rock is contained in Appendix A, Geologic Logs, and shown in section on Drawings 98/1 and 98/2.

### **Explorations**

Foundation explorations consisted of 15 borings drilled at the locations shown on Drawing 98/1. Nine of the borings were located along the embankment foundation alignment, three within the spillway location, and three along a preliminary outlet channel alignment. Undisturbed overburden samples were obtained using a Denison sampler. A 6-inch auger was used to obtain disturbed foundation samples. The underlying bedrock was cored using NX size diamond bits.

### **Laboratory Tests**

All of the disturbed overburden samples were analyzed for grain size distribution and water content. Approximately 50% of the samples were analyzed for Atterberg Limits. Atterberg Limit test results were used to aid in the visual classification of the remaining samples. Visual classification was done by experienced Southwestern Division Laboratory personnel. The undisturbed Denison barrel samples underwent tests to determine grain size analyses, water content, Atterberg Limits, and consolidation and shear strength characteristics of the foundation materials. Unconfined compression tests were run on selected rock core samples. Results of all the foundation tests are presented in SWDED-GL Report Number 15296 (see Appendix B). The visual classification, results of the Atterberg Limits, and grain distribution analyses are shown in summary in Table 4-1. The laboratory results of the strength tests are presented graphically on Drawing 98/5.

TABLE 4-1

## SUMMARY OF FOUNDATION MATERIALS

Class	Number of Samples	Samples Tested for Liquid Limit	Liquid Limit			Samples Tested for Percent Fines	Percent Fines			Percent of Total
			Min	Max	Avg		Min	Max	Avg	
CL	37	21	23	42	30.9	36	51	92	66.9	37
CH	4	2	54	55	54.5	4	67	90	75	4
SC	14	3	21	28	24.3	14	21	46	30.9	14
SH *	20	9	31	55	36.2	11	61	99	91	20
SS *	22	4	29	44	33.5	14	23	76	47.9	22
GC	2	0	--	--	----	2	14	33	23.5	2
TOTAL	99									

\* Rock materials subjected to soil tests.

### Seepage Control

The reservoir will be dry during normal operations. Through seepage is not expected to develop through the embankment foundation since the maximum pool duration is relatively short (7 to 10 days), and the foundation soils are relatively impervious.

### Settlement

A consolidation test was performed on a representative undisturbed foundation sample from boring PT-5. Due to relatively high preconsolidation pressures, the e-log p curves were adjusted by the procedures presented in Engineer Manual (EM) 1110-2-1904, subject: "Soil Mechanics Design - Settlement Analysis," dated January 1953. The maximum computed foundation settlement is 2 inches.

### EMBANKMENT MATERIALS

#### Required Excavation

Materials from required excavation will consist of both soil and rock. Required excavations include the outlet works, inlet and outlet channels, spillway, and inspection trench. Soil materials from these excavations are similar to the foundation soils described in the paragraph, Overburden, on page 4-2. The rock materials consist of soft to moderately hard shale and sandstone.

Excavation may require ripping, but blasting should not be necessary.

### Borrow Explorations and Tests

Borrow material for construction of the embankment is located upstream of the embankment as shown on Drawing 98/1. A total of 21 test pits were excavated within the upstream borrow area to determine material characteristics. A sufficient quantity of borrow material for construction of the embankment has been located within this area. Selected composite samples of borrow material were taken at two representative locations, TP-4 and TP-20. The composite samples were tested for shear strength at moisture contents ranging from 2% below to 2% above optimum. Results of all classification, shear strength, and moisture-density relationship tests for the borrow area soil samples are presented in SWDED-GL Report Number 15299 (see Appendix C). Results of all classifications and water table depths are shown in section on Drawings 98/3 and 98/4. The results of the grain size distribution and Atterberg Limits are summarized by classification on Table 4-2. The results of the shear strength tests are shown graphically on Drawing 98/5.

TABLE 4-2

### SUMMARY OF BORROW AREA SOILS

Class	Number of Samples	Samples Tested for Liquid Limit	Liquid Limit			Samples Tested for Percent Fines	Percent Fines			Percent of Total
			Min	Max	Avg		Min	Max	Avg	
CL	56	24	21	40	28.8	56	50	83	63.8	49.6
CH	1	--	--	--	----	1	77	77	77.0	0.9
SC	11	5	19	27	23.2	11	33	49	46.7	9.7
SH	14	8	24	51	35.4	14	33	98	71.2	12.4
GC	1	1	22	22	22.0	1	15	15	15.0	0.9
SM	15	--	--	--	----	15	19	48	37.5	13.3
ML	14	1	20	20	20.0	14	50	75	61.4	12.4
SP	1	--	--	--	----	1	11	11	11.0	0.9
TOTAL	113									



## **Description of Borrow Materials**

The borrow soils consist primarily of lean clay with lesser quantities of clayey and silty sand and sand and silt materials. Laboratory test results of the borrow samples are presented in SWDED-GL Report No. 15299 (see Appendix C) and are presented in section on Drawings 98/3 and 98/4.

## **EMBANKMENT DESIGN**

### **General**

The earthfill embankment is approximately 3,100 feet in length with a maximum height of 28.8 feet above the Plum Creek channel and with an average height of 24 feet across the floodplain. Releases will be made continuously through an uncontrolled outlet pipe at elevation 986.9 and through an uncontrolled spillway at elevation 1002.0.

### **Typical Sections**

The typical embankment section is shown on Drawing 12/3 in Appendix 5. The embankment slopes are 1 vertical to 3 horizontal which satisfy stability requirements and will permit mowing equipment to operate safely. The embankment will be constructed of materials obtained from the required excavation and upstream borrow area. The zoned embankment is comprised of an upstream impervious shell and a downstream random zone. The impervious fill will consist of clays (CL and CH), while the random zone will consist of silty and clayey sand, silt, sand, and clay materials. A 5-foot-deep inspection trench will be constructed along the centerline to locate abandoned pipes, debris, etc. The outer slopes will be protected by an 8-inch layer of suitable soil covered with grass.

### **Embankment Stability**

**Shear Strengths.** Results of triaxial (Q and R) and direct shear (S) tests on the borrow soils and foundation materials are contained in SWDED-GL Reports 15299 and 15296, respectively, and are plotted graphically as principal stress diagrams on Drawing 98/5. Composite borrow materials were remolded to -2, 0, and +2 percentage points of optimum prior to shear strength testing. Design strengths for the embankment and foundation material are shown in Table 4-3.

TABLE 4-3

## EMBANKMENT AND FOUNDATION DESIGN STRENGTHS

	Q		R		S	
	C (tsf)	Phi	C (tsf)	Phi	C (tsf)	Phi
Embankment	0.9	0	0.5	14	0	30
Foundation	1.2	0	0.3	14	0	27

**Procedures and Methods of Analysis.** The WES program UTEXAS2, as presented in Instruction Report GL-87-1 dated August 1987, was used for stability calculations. Stability of the embankment was determined for the conditions of sudden drawdown, end of construction, steady seepage, and partial pool by the Simplified Bishop method.

**Results.** Results of the stability analyses are shown on Drawings 98/6 and 98/7 and in Table 4-4. The required safety factors for each of the cases analyzed are listed in Table 4-4.

TABLE 4-4

## SAFETY FACTORS

Case	Safety Factor	
	Computed	Required
End of Construction Upstream and Downstream Slope	5.07	1.3
Partial Pool at Elevation 1000.0	1.78	1.5
Sudden Drawdown	1.60	1.0
Steady Seepage	2.86	1.5

**Seepage Controls**

A 24-inch layer of filter sand will be placed along the downstream portion of the outlet pipe, as shown on Drawing 12/4 in Appendix 5, to minimize the potential for piping along the outlet pipe. Filter sand shall have the following gradation:

Sieve Size	Percent by Weight Passing
3/8"	100
#4	95-100
#16	45-80
#50	10-30
#100	0-5

**Protection Stone**

Stone protection will not be required to protect the upstream embankment slopes against wave action. However, it will be required immediately downstream of the outlet pipe, as shown on Drawing 12/4 in Appendix 5. The stone protection will be an 18-inch layer of riprap underlaid with 9 inches of bedding and filter cloth. Gradations for the riprap and bedding are as follows:

18-Inch Riprap

Riprap Thickness (Inches)	Maximum Size (Pounds)	90 Percent Size (1) (Pounds)	Average Size (2) (Pounds)	8 Percent Size (3) (Pounds)
18	283	120 - 240	60-100	20

- (1) Defined as that size such that 90% of the stone, by weight, is smaller and 10% is larger.
- (2) Defined as that size such that 50% of the total riprap stone, by weight, is larger and 50% is smaller.
- (3) Not more than 8% of the riprap, by weight, shall consist of pieces weighing less than the weights shown for the applicable riprap thickness.

TABLE 4-3

## EMBANKMENT AND FOUNDATION DESIGN STRENGTHS

	Q		R		S	
	C (tsf)	Phi	C (tsf)	Phi	C (tsf)	Phi
Embankment	0.9	0	0.5	14	0	30
Foundation	1.2	0	0.3	14	0	27

**Procedures and Methods of Analysis.** The WES program UTEXAS2, as presented in Instruction Report GL-87-1 dated August 1987, was used for stability calculations. Stability of the embankment was determined for the conditions of sudden drawdown, end of construction, steady seepage, and partial pool by the Simplified Bishop method.

**Results.** Results of the stability analyses are shown on Drawings 98/6 and 98/7 and in Table 4-4. The required safety factors for each of the cases analyzed are listed in Table 4-4.

TABLE 4-4

## SAFETY FACTORS

Case	Safety Factor	
	Computed	Required
End of Construction Upstream and Downstream Slope	5.07	1.3
Partial Pool at Elevation 1000.0	1.78	1.5
Sudden Drawdown	1.60	1.0
Steady Seepage	2.86	1.5

**Seepage Controls**

A 24-inch layer of filter sand will be placed along the downstream portion of the outlet pipe, as shown on Drawing 12/4 in Appendix 5, to minimize the potential for piping along the outlet pipe. Filter sand shall have the following gradation:

Sieve Size	Percent by Weight Passing
3/8"	100
#4	95-100
#16	45-80
#50	10-30
#100	0-5

### Protection Stone

Stone protection will not be required to protect the upstream embankment slopes against wave action. However, it will be required immediately downstream of the outlet pipe, as shown on Drawing 12/4 in Appendix 5. The stone protection will be an 18-inch layer of riprap underlaid with 9 inches of bedding and filter cloth. Gradations for the riprap and bedding are as follows:

#### 18-Inch Riprap

Riprap Thickness (Inches)	Maximum Size (Pounds)	90 Percent Size (1) (Pounds)	Average Size (2) (Pounds)	8 Percent Size (3) (Pounds)
18	283	120 - 240	60-100	20

- (1) Defined as that size such that 90% of the stone, by weight, is smaller and 10% is larger.
- (2) Defined as that size such that 50% of the total riprap stone, by weight, is larger and 50% is smaller.
- (3) Not more than 8% of the riprap, by weight, shall consist of pieces weighing less than the weights shown for the applicable riprap thickness.

### 9-Inch Bedding

Sieve Size	Percent by Weight Passing
6"	100
4"	85-100
2"	60-80
1"	35-60
3/8"	10-35
No. 4	0-15

#### **Seismic Design**

The damsite is located within Seismic Zone 1; therefore, seismic stability is not a concern.

#### **SPILLWAY SLOPE PROTECTION**

Stone protection will not be required in the spillway to provide erosion protection for velocities up to the 100-year event. The 100-year spillway velocity (critical velocity at the crest) is 6.5 feet per second. A grass providing a well-knit cover (bermuda grass or equivalent) will be required on the spillway invert and side slopes.

#### **CONSTRUCTION CONSIDERATIONS**

##### **Outlet Structure Foundation**

The outlet structure will be constructed normal to the axis at station 15+30 where exploration results indicate the founding material will be shale. If weak and/or unstable material is encountered at the proposed outlet structure location, the undesirable material shall be removed and backfilled with clay soil compacted to 95% of maximum laboratory dry density.

##### **Channel Cleanup**

The creek channel within the limits of the embankment will be cleaned out to the depth necessary to remove unsuitable material. The creek banks, within the limits of the embankment, will be laid back on a 1V to 5H slope in overburden before fill placement is made.

## **Embankment Placement Controls**

**Moisture.** The placement moisture content range for random and impervious fills shall be from 2% dry to 2% wet of optimum. No tolerance will be permitted outside the specified range. Random and impervious field moisture will be controlled by the rapid method of construction. Filter sand shall be saturated prior to compaction.

**Compaction.** Impervious and random fill and filter sand shall be compacted to 95% of maximum laboratory dry density. Random and impervious materials shall be spread in an 8-inch loose thickness prior to compacting with a tamping roller at the specified moisture content. Filter sand shall be spread in a 12-inch layer prior to compacting with a vibratory roller. In confined areas and above the outlet pipe, filter sand shall be placed in a 6-inch loose layer prior to compacting with a vibratory plate compactor.

## **AVAILABILITY OF CONSTRUCTION MATERIALS**

### **Borrow**

Random and impervious materials for the embankment will be obtained from the upstream borrow area and from the required excavation. Some selective excavation may be required to obtain suitable impervious material. A sufficient quantity of material above the water table is available from the borrow areas to construct the embankment.

### **Required Excavation**

Suitable materials from the required excavations will be used for construction of the embankment. Unsuitable material from required excavation may be wasted along the upstream toe.

### **Filter Sand**

Material suitable for filter sand is available commercially from the E&A Materials, Inc., plant, located 10 miles south of Temple, Oklahoma, a haul distance of approximately 50 miles. Acceptable material may be available from undeveloped or more local sources.

### **Protection Stone**

The nearest known source of stone is a quarry located near Richards Spur, Oklahoma, a haul distance of approximately 58 miles.

**APPENDIX A**  
**GEOLOGIC LOGS**



<b>DRILLING LOG</b>		DIVISION SOUTHWEST	INSTALLATION WICHITA 6, TX	SHEET 1
1. PROJECT PLUM CREEK		10. SIZE AND TYPE OF BIT AUGER/CORE		
2. LOCATION (Coordinates or Station) 835091.30 1682758.20		11. DATUM FOR ELEVATION SHOWN (BM or MSL) MSL		
3. DRILLING AGENCY USCE-FT. WORTH		12. MANUFACTURER'S DESIGNATION OF DRILL FALLING 1500		
4. HOLE NO. (As shown on drawing title and file number) PT-2		13. OVERBURDEN SAMPLES	DISTURBED 4	UNDISTURBED 0
5. NAME OF DRILLER WILLIAMS		14. TOTAL NUMBER CORE BOXES 0		
6. DIRECTION OF HOLE <input checked="" type="checkbox"/> VERTICAL <input type="checkbox"/> INCLINED _____ DEG. FROM VERT.		15. ELEVATION GROUND WATER AFTER 24HR-- 26'		
7. THICKNESS OF OVERBURDEN 5.1		16. DATE HOLE	STARTED 02/08/91	COMPLETED 02/11/91
8. DEPTH DRILLED INTO ROCK 24.9		17. ELEVATION TOP OF HOLE 1002.4		
9. TOTAL DEPTH OF HOLE 30.0		18. TOTAL CORE RECOVERY FOR BORING 99.0 %		
ROBERT McVEY				

ELEVATION a	DEPTH b	LEGEND c	CLASSIFICATION OF MATERIALS (Description) d	% CORE RECOVERY e	BOX OR SAMPLE NO. f	REMARKS (Drilling time, water loss, depth of weathering, etc., if significant) g
1001.2	0.0		CLAY SAND (SC) (0.0 - 1.2) DARK REDDISH BROWN, MOIST, ROOTS		JAR A	TYPE ZONE AUGER 0.0- 9.0 CORE 9.0- 30.0  SAMPLE DEPTH JAR A 0.0- 1.2 JAR B 1.2- 4.5 JAR C 4.5- 5.1 JAR D 5.1- 8.5 JAR E 8.5- 10.0 CTN 1 12.1- 13.0 CTN 2 20.2- 21.1 CTN 3 25.7- 26.6 CTN 4 29.1- 29.8
	4.5		LEAN CLAY (CL) (1.2 - 5.1) SANDY, LIGHT YELLOWISH RED TO BROWN, MOIST, ROOTS, SCATTERED GRAVEL AFTER 4.5 FT		JAR B	
997.3	8.0		SHALE (SH) (5.1 - 12.1) BADLY WEATHERED TO A HARD CLAY CONSISTENCY, SLIGHTLY MOIST, RED, SILTY, BLACK NODULES		JAR C	
	12.0		SHALE (SH) (12.1 - 20.2) REDDISH BROWN, MOIST, SOFT (RX CLASS), FRACTURED, SCATTERED LIMESTONE POCKETS		JAR D	
980.3	16.0		SHALE (SH) (20.2 - 25.7) DARK REDDISH BROWN, MOIST, SOFT (RX CLASS), SANDY SILT POCKETS TO 1/2" SCATTERED THROUGHOUT		JAR E	
982.2	20.0		SHALE (SH) (25.7 - 29.1) DARK REDDISH BROWN, DAMP, SOFT (RX CLASS), SANDY SILT POCKETS TO 1/4"		CTN 1	
976.7	24.0		SANDSTONE (SS) (29.1 - 30.0) DARK REDDISH BROWN, MOIST, SOFT (RX CLASS), FINE SHALE BEDDINGS THROUGHOUT, POCKETS OF SILTY SAND		CTN 2	
973.3	28.0		BOTTOM OF HOLE		CTN 3	
972.4	32.0				CTN 4	
	36.0					
	40.0					

DRILLING LOG		DIVISION SOUTHWEST		INSTALLATION WICHITA 6, TX		SHEET OF 1 SHEETS	
1. PROJECT PLUM CREEK				10. SIZE AND TYPE OF BIT AUGER/CORE			
2. LOCATION (Coordinates or Station) 835015.40 1682943.20				11. DATUM FOR ELEVATION SHOWN (TBM or MSL) MSL			
3. DRILLING AGENCY USCE—FT. WORTH				12. MANUFACTURER'S DESIGNATION OF DRILL FAILING 1500			
4. HOLE NO. (As shown on drawing title and file number) PT-3				13. OVERBURDEN SAMPLES		DISTURBED 4	UNDISTURBED 0
5. NAME OF DRILLER WILLIAMS				14. TOTAL NUMBER CORE BOXES 0			
6. DIRECTION OF HOLE <input checked="" type="checkbox"/> VERTICAL <input type="checkbox"/> INCLINED _____ DEG. FROM VERT.				15. ELEVATION GROUND WATER **			
7. THICKNESS OF OVERBURDEN 5.3				16. DATE HOLE		STARTED 02/07/91	COMPLETED 02/08/91
8. DEPTH DRILLED INTO ROCK 19.7				17. ELEVATION TOP OF HOLE 996.8			
9. TOTAL DEPTH OF HOLE 25.0				18. TOTAL CORE RECOVERY FOR BORING 100.0 %			
ROBERT McVEY							
ELEVATION a	DEPTH b	LEGEND c	CLASSIFICATION OF MATERIALS (Description) d	% CORE RECOVERY e	BOX OR SAMPLE NO. f	REMARKS (Drilling time, water loss, depth of weathering, etc., if significant) g	
994.7			CLAY SAND (SC) (0.0 - 1.5) MOIST, SOME ROOTS		JAR A	** HOLE BAILED TO 23'. 72 HR CHECK AT 24' TO BOTTOM AND 21.5' TO WATER LEVEL.	
	3		LEAN CLAY (CL) (1.5 - 5.3) SANDY, MOIST, FEW ROOTS		JAR B	TYPE ZONE AUGER 0.0- 10.0 CORE 10.0- 25.0	
990.9			SHALE (SH) (5.3 - 21.6) POOR STRUCTURE UNTILL 10', MASSIVE, FRIABLE, BLOCKY STRUCTURE, SLIGHTLY MOIST, RED SAND/SILT SEAMS, VERY HARD AND WELL CEMENTED DOLOMITE SEAM 11.6' TO 11.7'		JAR C	SAMPLE DEPTH JAR A 0.0- 1.6 JAR B 1.6- 3.8 JAR C 3.8- 5.3 JAR D 5.3- 10.0 CTN 1 13.1- 14.0 CTN 2 22.1- 22.0	
	6				JAR D		
	9						
	12						
	15						
	18			100.0	CTN 1		
	21						
974.6			SANDSTONE (SS) (21.6 - 25.0) FINE GRAINED, MASSIVE, LIGHT OLIVE AND RED, SILTY, SOFT (RX CLASS)		CTN 2		
	24						
971.8							
	27		BOTTOM OF HOLE				
	30						

PROJECT  
PLUM CREEK

HOLE NO.  
PT-3

<b>DRILLING LOG</b>		DIVISION SOUTHWEST	INSTALLATION WICHITA 6, TX	SHEET 1
1. PROJECT PLUM CREEK		OF 1 SHEETS		
2. LOCATION 834939.50 1683128.50		10. SIZE AND TYPE OF BIT AUGER/CORE		
3. DRILLING AGENCY USCE-FT. WORTH		11. DATUM FOR ELEVATION SHOWN (NBM or MSL) MSL		
4. HOLE NO. (As shown on drawing title and file number) PT-4		12. MANUFACTURER'S DESIGNATION OF DRILL FAILING 1500		
5. NAME OF DRILLER WILLIAMS		13. OVERBURDEN SAMPLES DISTURBED 5 UNDISTURBED 0		
6. DIRECTION OF HOLE <input checked="" type="checkbox"/> VERTICAL <input type="checkbox"/> INCLINED _____ DEG. FROM VERT.		14. TOTAL NUMBER CORE BOXES 0		
7. THICKNESS OF OVERBURDEN 8.1		15. ELEVATION GROUND WATER AFTER 18HR-20.5		
8. DEPTH DRILLED INTO ROCK 16.9		16. DATE HOLE STARTED 02/06/91 COMPLETED 02/08/91		
9. TOTAL DEPTH OF HOLE 25.0		17. ELEVATION TOP OF HOLE 989.6		
		18. TOTAL CORE RECOVERY FOR BORING 88.0 %		
ROBERT McVEY				

ELEVATION	DEPTH	LEGEND	CLASSIFICATION OF MATERIALS (Description)	% CORE RECOVERY	BOX OR SAMPLE NO.	REMARKS (Drilling time, water loss, depth of weathering, etc., if applicable)
988.4	0.0		CLAY SAND (SC) (0.0 - 1.2) DARK YELLOWISH BROWN, MOIST, SOME ROOTS		JAR A	TYPE ZONE AUGER 0.0- 10.0 CORE 10.0- 25.0  SAMPLE DEPTH JAR A 0.0- 1.2 JAR B 1.2- 2.0 JAR C 2.0- 7.0 JAR D 7.0- 8.1 JAR E 8.1- 9.0 CTN 1 11.1- 12.0 CTN 2 14.2- 15.1 CTN 3 23.2- 24.2
987.8	1.2		LEAN CLAY (CL) (1.2 - 2.0) WITH SAND, LIGHT YELLOWISH RED MOIST, CALCAREOUS		JAR B	
	2.0		CLAY SAND (SC) (2.0 - 8.1) MOIST, CALCAREOUS, GRAVEL TO 3/4"		JAR C	
981.5	8.1		SHALE (SH) (8.1 - 11.1) RED AND LIGHT OLIVE, NO APPARENT WEATHERING, SOFT (RX CLASS)		JAR D	
978.5	11.1		SHALE (SH) (11.1 - 14.2) DARK REDDISH BROWN, MOIST, SOFT (RX CLASS), SMALL AMOUNT OF LIMESTONE SCATERED THROUGHOUT		JAR E	
968.8	14.2		SANDSTONE (SS) (14.2 - 23.2) MOIST, SOFT (RX CLASS), FINE SHALE BEDDING SEAMS THROUGHOUT 15.2 - 24.6 SOFT CLAY-SHALE SEAM AT 15.5', SILTY, WEAK TO NON CEMENTED 16.3 - 17.7 23.2 - 25.0 SHALE IN BEDDING SEAMS, GRAY- GREEN AND REDDISH BROWN	88.0	CTN 1	
	15.2				CTN 2	
	18					
	21					
	24				CTN 3	
964.8	25.0		BOTTOM OF HOLE			

<b>DRILLING LOG</b>		DIVISION SOUTHWEST	INSTALLATION WICHITA 6, TX	SHEET 1
1. PROJECT PLUM CREEK			10. SIZE AND TYPE OF BIT AUGER/CORE	
2. LOCATION (Coordinates or Station) 834787.80 1683498.60			11. DATUM FOR ELEVATION SHOWN (BM or MSL) MSL	
3. DRILLING AGENCY USCE-FT. WORTH			12. MANUFACTURER'S DESIGNATION OF DRILL FALLING 1500	
4. HOLE NO. (As shown on drawing title and the number) PT-5		13. OVERBURDEN SAMPLES DISTURBED 1    UNDISTURBED 5		
5. NAME OF DRILLER WILLIAMS			14. TOTAL NUMBER CORE BOXES 0	
6. DIRECTION OF HOLE <input checked="" type="checkbox"/> VERTICAL <input type="checkbox"/> INCLINED _____ DEG. FROM VERT.			15. ELEVATION GROUND WATER AFTER 18HR-23'	
7. THICKNESS OF OVERBURDEN 10.0			16. DATE HOLE STARTED 02/05/91    COMPLETED 02/05/91	
8. DEPTH DRILLED INTO ROCK 15.0			17. ELEVATION TOP OF HOLE 890.0	
9. TOTAL DEPTH OF HOLE 25.0			18. TOTAL CORE RECOVERY FOR BORING 99.0 %	
ROBERT McVEY				

ELEVATION a	DEPTH b	LEGEND c	CLASSIFICATION OF MATERIALS (Description) d	% CORE RECOVERY e	BOX OR SAMPLE NO. f	REMARKS (Drilling time, water loss, depth of weathering, etc., if significant) g
988.0			LEAN CLAY (CL) (0.0 - 2.0) DARK BROWNISH RED, MOIST		JAR A	SURFACE SILT WAS DOZED OFF.
987.1	3		LEAN CLAY (CL) (2.0 - 2.9) MOIST, VERY STIFF, PENE=3.25, 1/2" DIAMETER TREE ROOT		DB 1	TYPE ZONE AUGER 0.0- 2.0 DENISON 2.0- 12.0 CORE 12.0- 25.0
984.0	6		LEAN CLAY (CL) (2.9 - 6.0) SANDY, BROWN, HARD, PENE>4, MOIST, CALCAREOUS, FEW CALCAREOUS NODULES TO 1/2" SCATTERED		DB 2	SAMPLE DEPTH JAR A 0.0- 2.0 DB 1 2.0- 4.0 DB 2 4.0- 6.0 DB 3 6.0- 8.0 DB 4 8.0- 10.0 DB 5 10.0- 12.0 CTN 1 12.6- 13.5 CTN 2 22.4- 23.3
980.0	9		LEAN CLAY (CL) (6.0 - 10.0) WITH SAND, MOIST, VERY STIFF, LPENE=2.75-3.25, CALCAREOUS, SCATTERED CALCAREOUS NODULES, VERY SANDY IN BOTTOM 0.8' SCATTERED VERY SOFT SANDSTONE NODULES, SHALY IN BOTTOM 1.0'		DB 3	
					DB 4	
970.4	12		SHALE (SH) (10.0 - 12.6) DARK RED, MOIST, HARD, PENE>4, SOFT (RX CLASS), SCATTERED SILT POCKETS, SANDY IN TOP 0.2'		DB 5	
					CTN 1	
	15		SHALE (SH) (12.6 - 22.4) MOIST, SOFT (RX CLASS), HIGHLY FRACTURED 12.4 - 14.0 LIGHT OLIVE SEAM AT 13.1' TO 13.2', SILTY			
	18					
	21					
967.6	24		SANDSTONE (SS) (22.4 - 25.0) MOIST, SOFT (RX CLASS), SILTY, SHALE SEAMS, OPEN FRACTURE 21.4' TO 21.9', VERY SOFT AND NON CEMENTED FROM 21.9' TO 22.4'		CTN 2	
965.0						
	27		BOTTOM OF HOLE			
	30					

DRILLING LOG		DIVISION SOUTHWEST	INSTALLATION WICHITA 6, TX	SHEET 1
1. PROJECT PLUM CREEK			10. SIZE AND TYPE OF BIT AUGER/CORE	
2. LOCATION (Coordinates or Station) 834836.10 1683868.70			11. DATUM FOR ELEVATION SHOWN (TBM or MSL) MSL	
3. DRILLING AGENCY USCE-FT. WORTH			12. MANUFACTURER'S DESIGNATION OF DRILL FAILING 1500	
4. HOLE NO. (As shown on drawing title and file number) PT-6			13. OVERBURDEN SAMPLES DISTURBED 8 UNDISTURBED 0	
5. NAME OF DRILLER WILLIAMS			14. TOTAL NUMBER CORE BOXES 0	
6. DIRECTION OF HOLE <input checked="" type="checkbox"/> VERTICAL <input type="checkbox"/> INCLINED _____ DEG. FROM VERT.			15. ELEVATION GROUND WATER AFTER 24HR-23.4	
7. THICKNESS OF OVERBURDEN 15.5			16. DATE HOLE STARTED 01/15/91 COMPLETED 02/06/91	
8. DEPTH DRILLED INTO ROCK 9.5			17. ELEVATION TOP OF HOLE 992.4	
9. TOTAL DEPTH OF HOLE 25.0			18. TOTAL CORE RECOVERY FOR BORING 100.0 %	
ROBERT McVEY				

ELEVATION	DEPTH	LEGEND	CLASSIFICATION OF MATERIALS (Description)	% CORE RECOVERY	BOX OR SAMPLE NO.	REMARKS (Drilling time, water loss, depth of weathering, etc., if significant)
a	b	c	d	e	f	g
991.6			LEAN CLAY (CL) (0.0 - 0.8) DARK BROWNISH RED, MOIST, SOME ROOTS		JAR A	MOST RECOVERY TOO FRAGMENTED TO SAMPLE.
	3		LEAN CLAY (CL) (0.8 - 3.8) WITH SAND, LIGHT BROWNISH RED, MOIST, ROOTS 2.5 - 3.8 CALCAREOUS		JAR B	
988.6			FAT CLAY (CH) (3.8 - 7.0) WITH SAND, LIGHT YELLOWISH OLIVE WITH RED, MOIST		JAR C	TYPE ZONE AUGER 0.0- 16.0 AUGER 16.0- 16.5 CORE 16.5- 25.0
985.4			CLAY SAND (SC) (7.0 - 11.5) MOIST, CALCAREOUS		JAR D	SAMPLE DEPTH JAR A 0.0- 0.8 JAR B 0.8- 2.5 JAR C 2.5- 3.8 JAR D 3.8- 7.0 JAR E 7.0- 11.5 JAR F 11.5- 13.0 JAR G 13.0- 15.0 JAR H 15.0- 15.5 CTN 1 22.7- 23.5
980.9			CLAY SAND (SC) (11.5 - 15.0) LIGHT YELLOWISH RED, MOIST		JAR E	
977.4			CLAY SAND (SC) (15.0 - 15.5) WITH GRAVEL, DARK RED, MOIST, CALCAREOUS, GRAVEL TO 3/8"		JAR F	
976.9			SANDSTONE (SS) (15.5 - 25.0) FINE/MEDIUM GRAINED, THIN SHALE SEAMS SCATTERED, SOFT (RX CLASS), UNWEATHERED, NON TO WEAK CEMENTATION, HARD AND WELL CEMENTED SEAM FROM 23.5' TO 24.4'	100.0	JAR G	
	18				JAR H	
	21					
	24				CTN 1	
967.4			BOTTOM OF HOLE			
	27					
	30					



DRILLING LOG		DIVISION SOUTHWEST	INSTALLATION WICHITA 6, TX	SHEET 1
1. PROJECT PLUM CREEK		10. SIZE AND TYPE OF BIT AUGER/CORE		
2. LOCATION (Coordinates or Station) 834485.00 1684237.20		11. DATUM FOR ELEVATION SHOWN (TBM or MSL) MSL		
3. DRILLING AGENCY USCE-FT. WORTH		12. MANUFACTURER'S DESIGNATION OF DRILL FALLING 1500		
4. HOLE NO. (As shown on drawing title and file number) PT-7		13. OVERBURDEN SAMPLES	DISTURBED 5	UNDISTURBED 0
5. NAME OF DRILLER WILLIAMS		14. TOTAL NUMBER CORE BOXES 0		
6. DIRECTION OF HOLE <input checked="" type="checkbox"/> VERTICAL <input type="checkbox"/> INCLINED _____ DEG. FROM VERT.		15. ELEVATION GROUND WATER AFTER 18HR - 21'		
7. THICKNESS OF OVERBURDEN 7.5		16. DATE HOLE	STARTED 02/04/91	COMPLETED 02/04/91
8. DEPTH DRILLED INTO ROCK 17.7		17. ELEVATION TOP OF HOLE 991.1		
9. TOTAL DEPTH OF HOLE 25.2		18. TOTAL CORE RECOVERY FOR BORING 100.0 %		
ROBERT McVEY				

ELEVATION	DEPTH	LEGEND	CLASSIFICATION OF MATERIALS (Description)	% CORE RECOVERY	BOX OR SAMPLE NO.	REMARKS (Drilling time, water loss, depth of weathering, etc., if significant)
a	b	c	d	e	f	g
987.6	3		LEAN CLAY (CL) (0.0 - 3.4) SANDY, DARK BROWNISH RED, MOIST, MANY ROOTS TOP 1.2'	100.0	JAR A	TYPE ZONE AUGER 0.0- 7.0 CORE 7.0- 25.2  SAMPLE DEPTH JAR A 0.0- 1.2 JAR B 1.2- 3.4 JAR C 3.4- 4.8 JAR D 4.8- 7.5 JAR E 10.0- 10.2 CTN 1 12.6- 13.5 CTN 2 21.3- 22.2 CTN 3 23.4- 24.3
983.5	6		LEAN CLAY (CL) (3.4 - 7.5) SANDY, LIGHT YELLOWISH RED, MOIST, CALCAREOUS		JAR B	
978.3	9		SHALE (SH) (7.5 - 14.7) BADLY WEATHERED TO A VERY STIFF/HARD CLAY CONSISTENCY UNTIL 12.6', THEN NO APPARENT WEATHERING, SLIGHTLY MOIST, MASSIVE TO COARSELY BEDDED, VERY SILTY AND SANDY SEAMS		JAR C	
974.6	12		SANDSTONE (SS) (14.7 - 16.4) FINE GRAINED, X-BEDDED, RED, SOFT (RX CLASS), WEAKLY CEMENTED, VERY SILTY		JAR D	
967.8	15		SHALE (SH) (16.4 - 23.2) UNWEATHERED, SOFT (RX CLASS), VERY SILTY AND SANDY, MASSIVE TO THIN BEDDED	JAR E		
965.9	18		SANDSTONE (SS) (23.2 - 25.2) FINE, LIGHT OLIVE WITH RED, WEAK TO MODERATE CEMENT, SILTY, X-BEDDED, SOFT (RX CLASS), SHALE SEAM 24.7' TO 24.9'	CTN 1		
	21			CTN 2		
	24			CTN 3		
	27		BOTTOM OF HOLE			
	30					

<b>DRILLING LOG</b>		DIVISION SOUTHWEST	INSTALLATION WICHITA 6, TX	SHEET 1 OF 1 SHEETS
1. PROJECT PLUM CREEK		10. SIZE AND TYPE OF BIT AUGER/CORE		
2. LOCATION (Coordinates or Station) 834338.10 1684595.80		11. DATUM FOR ELEVATION SHOWN (TBM or MSL) MSL		
3. DRILLING AGENCY USCE-FT. WORTH		12. MANUFACTURER'S DESIGNATION OF DRILL FAILING 1500		
4. HOLE NO. (As shown on drawing title and file number) PT-8		13. OVERBURDEN SAMPLES DISTURBED 1 UNDISTURBED 5		
5. NAME OF DRILLER WILLIAMS		14. TOTAL NUMBER CORE BOXES 0		
6. DIRECTION OF HOLE <input checked="" type="checkbox"/> VERTICAL <input type="checkbox"/> INCLINED _____ DEG. FROM VERT.		15. ELEVATION GROUND WATER ***		
7. THICKNESS OF OVERBURDEN 10.0		16. DATE HOLE STARTED 01/31/91 COMPLETED 01/31/91		
8. DEPTH DRILLED INTO ROCK 15.0		17. ELEVATION TOP OF HOLE 986.5		
9. TOTAL DEPTH OF HOLE 25.0		18. TOTAL CORE RECOVERY FOR BORING 90.0 %		
ROBERT McVEY				

ELEVATION	DEPTH	LEGEND	CLASSIFICATION OF MATERIALS (Description)	% CORE RECOVERY	BOX OR SAMPLE NO.	REMARKS (Drilling time, water loss, depth of overburden, etc., if significant)
984.5			LEAN CLAY (CL) (0.0 - 2.0) SANDY, DARK BROWNISH RED, MOIST, ROOTS		JAR A	see 72 HR CHECK AT 11.8' AND CAVED TO 23'. HOLE OFFSET 5' SOUTH FOR PRESSURE TEST. UNABLE TO SEAT PACKER.  TYPE ZONE AUGER 0.0- 2.0 DENISON 2.0- 12.0 CORE 12.0- 25.0  SAMPLE DEPTH JAR A 0.0- 2.0 DB 1 2.0- 4.0 DB 2 4.0- 6.0 DB 3 6.0- 8.0 DB 4 8.0- 10.0 DB 5 10.0- 12.0 CTN 1 14.2- 15.0 CTN 2 19.3- 20.2
982.5	3		LEAN CLAY (CL) (2.0 - 4.0) SANDY, REDDISH BROWN, MOIST, VERY STIFF, PENE=2.75, CALCAREOUS, SCATTERED SAND POCKETS, TOP 0.2' IS VERY SOFT WITH ROOTS THROUGHOUT		DB 1	
980.5	6		LEAN CLAY (CL) (4.0 - 6.0) SANDY, REDDISH BROWN, MOIST, VERY STIFF, PENE=3.75, CALCAREOUS, SEAMS AND LENSES, ROOTS IN TOP 0.4'		DB 2	
978.5			LEAN CLAY (CL) (6.0 - 8.0) SANDY, BROWN, MOIST, HARD, PENE=4, CALCAREOUS		DB 3	
976.5	8		LEAN CLAY (CL) (8.0 - 10.0) SANDY, BROWN, MOIST, HARD, PENE=4, SCATTERED CALCAREOUS NODULES		DB 4	
972.3	12		SANDSTONE (SS) (10.0 - 14.2) DARK RED AND OLIVE YELLOW, VERY MOIST, SOFT, PENE=1.5, ALTERNATING LAYERS OF SOFT SANDSTONE AND SAND, SOME SHALE		DB 5	
	15		SANDSTONE (SS) (14.2 - 25.0) LIGHT OLIVE BROWN AND GRAY- GREEN, MOIST, SOFT (RX CLASS),		CTN 1	
	18			90.0		
	21				CTN 2	
	24					
961.5						
	27		BOTTOM OF HOLE			
	30					

<b>DRILLING LOG</b>		DIVISION SOUTHWEST	INSTALLATION WICHITA 6, TX	SHEET 1
1. PROJECT PLUM CREK		10. SIZE AND TYPE OF BIT AUGER/CORE		
2. LOCATION (Coordinates or Station) 834256.80 1684794.00		11. DATUM FOR ELEVATION SHOWN (TBM or MSL) MSL		
3. DRILLING AGENCY USCE--FT. WORTH		12. MANUFACTURER'S DESIGNATION OF DRILL FAILING 1500		
4. HOLE NO. (As shown on drawing title and file number) PT-9		13. OVERBURDEN SAMPLES	DISTURBED 3	UNDISTURBED 0
5. NAME OF DRILLER WILLIAMS		14. TOTAL NUMBER CORE BOXES 0		
6. DIRECTION OF HOLE <input checked="" type="checkbox"/> VERTICAL <input type="checkbox"/> INCLINED _____ DEG. FROM VERT.		15. ELEVATION GROUND WATER AFTER 24HR 15.3		
7. THICKNESS OF OVERBURDEN 7.8		18. DATE HOLE	STARTED 01/28/91	COMPLETED 01/28/91
8. DEPTH DRILLED INTO ROCK 17.9		17. ELEVATION TOP OF HOLE 991.2		
9. TOTAL DEPTH OF HOLE 25.7		18. TOTAL CORE RECOVERY FOR BORING 84.0 %		
ROBERT McVEY				

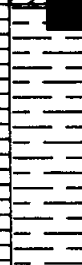
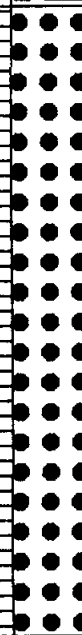
ELEVATION	DEPTH	LEGEND	CLASSIFICATION OF MATERIALS (Description)	% CORE RECOVERY	BOX OR SAMPLE NO.	REMARKS (Drilling time, water loss, depth of weathering, etc., if significant)
a	b	c	d	e	f	g
	0		LEAN CLAY (CL) (0.0 - 7.8) SANDY, LIGHT YELLOWISH RED, MOIST, SOME ROOTS 1.7 - 6.6 CALCAREOUS		JAR A	HOLE OFFSET 5' NORTH FROM SURVEY STAKE.
	3				JAR B	TYPE ZONE AUGER 0.0- 5.0 CORE 5.0- 25.7
	6				JAR C	SAMPLE DEPTH JAR A 0.0- 1.7 JAR B 1.7- 2.4 JAR C 2.4- 6.6 CTN 1 7.8- 8.8 CTN 2 13.1- 14.0 CTN 3 21.4- 22.0
983.4	7.8		SHALE (SH) (7.8 - 13.1) REDDISH BROWN, MOIST, HARD, PENE-4, SOFT (RX CLASS), SILTY SAND SEAM AT 8.1', SANDSTONE IN BOTTOM 0.4'		CTN 1	
	12					
978.1	13.1		SANDSTONE (SS) (13.1 - 25.7) LIGHT OLIVE BROWN, MOIST, SOFT (RX CLASS)	84.0	CTN 2	
	15					
	18					
	21					
	24				CTN 3	
965.5	25.7		BOTTOM OF HOLE			
	27					
	30					



<b>DRILLING LOG</b>		DIVISION <b>SOUTHWEST</b>		INSTALLATION <b>WICHITA 6, TX</b>		SHEET <b>1</b> OF 1 SHEETS	
1. PROJECT <b>PLUM CREEK</b>				10. SIZE AND TYPE OF BIT <b>AUGER/CORE</b>			
2. LOCATION (Coordinates or Station) <b>834143.00 1685071.50</b>				11. DATUM FOR ELEVATION SHOWN (TBM or MSL) <b>MSL</b>			
3. DRILLING AGENCY <b>USCE-FT. WORTH</b>				12. MANUFACTURER'S DESIGNATION OF DRILL <b>FALLING 1500</b>			
4. HOLE NO. (As shown on drawing title and file number) <b>PT-10</b>				13. OVERBURDEN SAMPLES		DISTURBED <b>2</b> UNDISTURBED <b>0</b>	
5. NAME OF DRILLER <b>WILLIAMS</b>				14. TOTAL NUMBER CORE BOXES <b>0</b>			
6. DIRECTION OF HOLE <input checked="" type="checkbox"/> VERTICAL <input type="checkbox"/> INCLINED _____ DEG. FROM VERT.				15. ELEVATION GROUND WATER <b>***</b>		18. DATE HOLE STARTED <b>01/17/91</b> COMPLETED <b>01/17/91</b>	
7. THICKNESS OF OVERBURDEN <b>3.0</b>				17. ELEVATION TOP OF HOLE <b>1004.6</b>			
8. DEPTH DRILLED INTO ROCK <b>27.0</b>				18. TOTAL CORE RECOVERY FOR BORING <b>95.0 %</b>			
9. TOTAL DEPTH OF HOLE <b>30.0</b>				<b>ROBERT McVEY</b>			

ELEVATION g	DEPTH b	LEGEND c	CLASSIFICATION OF MATERIALS (Description) d	% CORE RECOVERY e	BOX OR SAMPLE NO. f	REMARKS (Drilling time, water loss, depth of weathering, etc. if significant) g
1001.8			LEAN CLAY (CL) (0.0 - 3.0) SANDY, LIGHT YELLOWISH RED, MOIST, CALCAREOUS, SOME ROOTS		JAR A	IT RAINED THE 17TH AND 18TH--POSSIBLY SOME SURFACE RUNOFF. *** 72 HR CHECK--12.5'  TYPE ZONE AUGER 0.0- 5.5 CORE 5.5- 30.0  SAMPLE DEPTH JAR A 0.0- 3.0 JAR B 3.0- 5.5 CTN 1 6.4- 7.3 CTN 2 13.1- 14.0 CTN 3 20.2- 21.1 CTN 4 22.5- 23.3
	4		SHALE (SH) (3.0 - 21.2) NO APPARENT WEATHERING, DRY, MASSIVE, BLOCKY STRUCTURE, SOFT (RX CLASS), DENTRITIC STAINS THROUGHOUT, HEALED FRACTURE AT 7.5' TO 9.0', SANDY/SILTY AFTER 20'		JAR B	
	8				CTN 1	
	12				CTN 2	
	16					
	20			95.0		
983.4			SANDSTONE (SS) (21.2 - 30.0) ARGILLACEOUS, DARK RED, MOIST, SOFT (RX CLASS), SILTY SAND LENSES IN BOTTOM		CTN 3	
	24				CTN 4	
	28					
974.6			BOTTOM OF HOLE			
	32					
	36					
	40					

<b>DRILLING LOG</b>		DIVISION SOUTHWEST	INSTALLATION WICHITA 6, TX	SHEET 1
1. PROJECT PLUM CREEK		10. SIZE AND TYPE OF BIT AUGER/CORE		
2. LOCATION (Coordinates or Station) 834029.30 1685349.10		11. DATUM FOR ELEVATION SHOWN (TBM or MSL) MSL		
3. DRILLING AGENCY USCE--FT. WORTH		12. MANUFACTURER'S DESIGNATION OF DRILL FAILING 1500		
4. HOLE NO. (As shown on drawing title and the number) PT-11		13. OVERBURDEN SAMPLES	DISTURBED 2	UNDISTURBED 0
5. NAME OF DRILLER WILLIAMS		14. TOTAL NUMBER CORE BOXES 3		
6. DIRECTION OF HOLE <input checked="" type="checkbox"/> VERTICAL <input type="checkbox"/> INCLINED _____ DEG. FROM VERT.		15. ELEVATION GROUND WATER AFTER 18HR-- 18'		
7. THICKNESS OF OVERBURDEN 1.0		16. DATE HOLE	STARTED 01/23/91	COMPLETED 01/23/91
8. DEPTH DRILLED INTO ROCK 24.0		17. ELEVATION TOP OF HOLE 1020.7		
9. TOTAL DEPTH OF HOLE 25.0		18. TOTAL CORE RECOVERY FOR BORING 79.0 %		
ROBERT McVEY				

ELEVATION a	DEPTH b	LEGEND c	CLASSIFICATION OF MATERIALS (Description) d	% CORE RECOVERY e	BOX OR SAMPLE NO. f	REMARKS (Drilling time, water loss, depth of weathering, etc., if significant) g
1019.7			LEAN CLAY (CL) (0.0 - 1.0) HIGH PLACTICITY, SOFT, MOIST, DARK BROWN, VERY GRAVELLY		JAR A	RECOVERED CORE WAS BADLY FRAGMENTED AND FELL APART RAPIDLY WITH HANDLING.  TYPE            ZONE AUGER            0.0- 5.5 CORE            5.5- 25.0  SAMPLE        DEPTH JAR A        0.0- 1.0 JAR B        1.0- 5.5 BOX 1        5.5- 13.0 BOX 2        13.0- 17.0 BOX 3        18.5- 23.4
	3		SANDSTONE (SS) (1.0 - 5.5) FINE GRAINED, NONCEMENTED, FINE TO COARSE BEDDED, SLIGHTLY MOIST TO DRY, RED WITH WHITE ZONES, SILTY, CLAY SEAMS		JAR B	
1015.2	6		SANDSTONE (SS) (5.5 - 11.5) REDDISH BROWN, DRY, MODERATELY HARD (RX CLASS), THIN BEDDING SEAMS, THIN SHALE SEAMS		BOX 1	
1009.2	12		SHALE (SH) (11.5 - 25.0) BADLY WEATHERED TO A HIGH PLASTIC STIFF/VERY STIFF CLAY CONSISTENCY UNTIL 13.5', THEN AN UNWEATHERED MASSIVE UNIT, GOOD BLOCKY STRUCTURE, SOFT (RX CLASS)	79.0	BOX 2	
	15					
	18					
	21				BOX 3	
	24					
995.7			BOTTOM OF HOLE			
	27					
	30					

DRILLING LOG		DIVISION	SOUTHWEST	INSTALLATION	WICHITA 6, TX	SHEET	1
1. PROJECT		PLUM CREEK		10. SIZE AND TYPE OF BIT		AUGER/CORE	
2. LOCATION (Coordinates or Station)		834240.10 1685333.40		11. DATUM FOR ELEVATION SHOWN (TBM or MSL)		MSL	
3. DRILLING AGENCY		USCE--FT. WORTH		12. MANUFACTURER'S DESIGNATION OF DRILL			
4. HOLE NO. (As shown on drawing title and its number)		PT-12		13. OVERBURDEN SAMPLES		DISTURBED	2
5. NAME OF DRILLER		WILLIAMS		14. TOTAL NUMBER CORE BOXES		0	
6. DIRECTION OF HOLE <input checked="" type="checkbox"/> VERTICAL <input type="checkbox"/> INCLINED _____ DEG. FROM VERT.				15. ELEVATION GROUND WATER AFTER 72HR 15'			
7. THICKNESS OF OVERBURDEN		1.0		16. DATE HOLE		STARTED	01/25/91
8. DEPTH DRILLED INTO ROCK		19.2		17. ELEVATION TOP OF HOLE		1021.5	
9. TOTAL DEPTH OF HOLE		20.2		18. TOTAL CORE RECOVERY FOR BORING		98.0 %	
ROBERT McVEY							







ELEVATION	DEPTH	LEGEND	CLASSIFICATION OF MATERIALS (Description)	% CORE RECOVERY	BOX OR SAMPLE NO.	REMARKS (Drilling time, water loss, depth of weathering, etc., if significant)
a	b	c	d	e	f	g
1020.5			LEAN CLAY (CL) (0.0 - 1.0) SANDY, DARK REDDISH BROWN, MOIST, SOME ROOTS		JAR A	TYPE AUGER CORE
	3		SANDSTONE (SS) (1.0 - 10.4) NO APPARENT WEATHERING, FINE GRAINED, SLIGHTLY MOIST, RED AND LIGHT OLIVE WITH BLACK DENDRITIC STAINS THROUGHOUT, MOSTLY WEAKLY CEMENTED, SOFT TO MOD. HARD (ROCK CLASS)		JAR B	ZONE 0.0- 5.0
	6					SAMPLE DEPTH
	9				BOX 1	JAR A 0.0- 1.0
	12		SHALE (SH) (10.4 - 20.2) WEATHERED, LIGHT OLIVE BROWN, MOIST, SOFT (RX CLASS), CALCAREOUS 14.1-14.3 OPEN FRAC. W/ SLICKS 16.5-16.8 OPEN FRAC. W/ SLICKS	98.0	BOX 2	JAR B 1.0- 5.0
	15				BOX 3	BOX 1 5.0- 9.0
	18				BOX 4	BOX 2 9.3- 14.3
1001.3	21		BOTTOM OF HOLE			BOX 3 14.3- 17.4
	24					BOX 4 17.4- 20.2
	27					
	30					

DRILLING LOG		DIVISION		SOUTHWEST		INSTALLATION		WICHITA 6, TX		SHEET 1 OF 1 SHEETS	
1. PROJECT PLUM CREEK						10. SIZE AND TYPE OF BIT AUGER/CORE					
2. LOCATION (Coordinate or Station) 833847.80 1885264.00						11. DATUM FOR ELEVATION SHOWN (TBM or MSL) MSL					
3. DRILLING AGENCY USCE-FT. WORTH						12. MANUFACTURER'S DESIGNATION OF DRILL FAILING 1500					
4. HOLE NO. (As shown on drawing title and file number) PT-13						13. OVERBURDEN SAMPLES		DISTURBED 3		UNDISTURBED 0	
5. NAME OF DRILLER WILLIAMS						14. TOTAL NUMBER CORE BOXES 0					
6. DIRECTION OF HOLE <input checked="" type="checkbox"/> VERTICAL <input type="checkbox"/> INCLINED _____ DEG. FROM VERT.						15. ELEVATION GROUND WATER DRY HOLE		16. DATE HOLE STARTED 01/16/91 COMPLETED 01/16/91			
7. THICKNESS OF OVERBURDEN 3.3						17. ELEVATION TOP OF HOLE 1008.9					
8. DEPTH DRILLED INTO ROCK 11.7						18. TOTAL CORE RECOVERY FOR BORING 92.0 %					
9. TOTAL DEPTH OF HOLE 15.0						ROBERT McVEY					
ELEVATION	DEPTH	LEGEND	CLASSIFICATION OF MATERIALS (Description)	% CORE RECOVERY	BOX OR SAMPLE NO.	REMARKS (Drilling time, water loss, depth of weathering, etc., if significant)					
1007.5			CLAY SAND (SC) (0.0 - 1.4) DARK BROWNISH RED, MOIST		JAR A	TYPE ZONE AUGER 0.0- 6.0 CORE 6.0- 15.0					
1005.8	2		FAT CLAY (CH) (1.4 - 3.3) SANDY, LIGHT YELLOWISH BROWN, MOIST		JAR B	SAMPLE DEPTH JAR A 0.0- 1.4 JAR B 1.4- 3.3 JAR C 3.3- 6.0 CTN 1 9.7- 10.6					
	4		SHALE (SH) (3.3 - 9.7) BADLY WEATHERED TO A HARD CLAY CONSISTENCY, DRY, RED WITH OLIVE ZONES, A FEW BLACK CARBON SPHERES, REMNANT BLOCKY STRUCTURE		JAR C						
973.3	10		SHALE (SH) (9.7 - 15.0) DARK RED, MOIST, SOFT (RX CLASS), GRAY-GREEN SAND POCKETS TO 3/4", HIGHLY FRACTURED, SLICKENSIDED, PLANT ROOTS AND DENTRIC STAINS THROUGHOUT, POSSIBLE JOINTED AT 11.9'; 12.5' TO 12.6'; AND 13.0' TO 13.2'(ALL HORIZONTAL)	92.0	CTN 1						
993.9	16		BOTTOM OF HOLE								

<b>DRILLING LOG</b>		DIVISION SOUTHWEST	INSTALLATION WICHITA 6, TX	SHEET 1
1. PROJECT PLUM CREEK		10. SIZE AND TYPE OF BIT AUGER/CORE		
2. LOCATION (Coordinates or Station) 833810.70 1684593.50		11. DATUM FOR ELEVATION SHOWN (TBM or MSL) MSL		
3. DRILLING AGENCY USCE-Ft. WORTH		12. MANUFACTURER'S DESIGNATION OF DRILL FALLING 1500		
4. HOLE NO. (As shown on drawing title and file number) PT-14		13. OVERBURDEN SAMPLES	DISTURBED 2	UNDISTURBED 0
5. NAME OF DRILLER WILLIAMS		14. TOTAL NUMBER CORE BOXES 0		
6. DIRECTION OF HOLE <input checked="" type="checkbox"/> VERTICAL <input type="checkbox"/> INCLINED _____ DEG. FROM VERT.		15. ELEVATION GROUND WATER ***		
7. THICKNESS OF OVERBURDEN 5.0		16. DATE HOLE		STARTED 01/29/91 COMPLETED 01/29/91
8. DEPTH DRILLED INTO ROCK 4.5		17. ELEVATION TOP OF HOLE 986.4		
9. TOTAL DEPTH OF HOLE 9.5		18. TOTAL CORE RECOVERY FOR BORING 98.0 %		
ROBERT McVEY				

ELEVATION a	DEPTH b	LEGEND c	CLASSIFICATION OF MATERIALS (Description) d	% CORE RECOVERY e	BOX OR SAMPLE NO. f	REMARKS (Drilling time, water loss, depth of weathering, etc., if significant) g
985.2	1		LEAN CLAY (CL) (0.0 - 1.2) SANDY, DARK BROWNISH RED, MOIST, ROOTS		JAR A	*** HOLE NOT BAILED BECAUSE OF STANDING WATER IN AREA.  TYPE ZONE AUGER 0.0- 5.5 CORE 5.5- 9.5
	2		LEAN CLAY (CL) (1.2 - 5.0) SANDY, LIGHT YELLOWISH RED, MOIST		JAR B	SAMPLE DEPTH JAR A 0.0- 1.2 JAR B 1.2- 4.6 BOX 1 5.5- 9.2
981.4	5		SANDSTONE (SS) (5.0 - 9.5) DARK REDDISH BROWN, MOIST, SOFT (RX CLASS), THIN ALTERNATING SHALE SEAMS THROUGHOUT		BOX 1	
	6			98.0		
976.9	9					
	10		BOTTOM OF HOLE			

DRILLING LOG		DIVISION	SOUTHWEST		INSTALLATION	WICHITA 6, TX		SHEET	1
1. PROJECT					10. SIZE AND TYPE OF BIT				
2. LOCATION (Coordinates or Station)					11. DATUM FOR ELEVATION SHOWN (TBM or MSL)				
3. DRILLING AGENCY					12. MANUFACTURER'S DESIGNATION OF DRILL				
4. HOLE NO. (As shown on drawing title and file number)					13. OVERBURDEN SAMPLES		DISTURBED		UNDISTURBED
5. NAME OF DRILLER					14. TOTAL NUMBER CORE BOXES		0		0
6. DIRECTION OF HOLE					15. ELEVATION GROUND WATER		***		
7. THICKNESS OF OVERBURDEN					16. DATE HOLE		STARTED		COMPLETED
8. DEPTH DRILLED INTO ROCK					17. ELEVATION TOP OF HOLE		982.2		%
9. TOTAL DEPTH OF HOLE					18. TOTAL CORE RECOVERY FOR BORING		100.0		%
					ROBERT McVEY				
ELEVATION	DEPTH	LEGEND	CLASSIFICATION OF MATERIALS (Description)	% CORE RECOVERY	BOX OR SAMPLE NO.	REMARKS (Drilling time, water loss, depth of weathering, etc., if significant)			
	1		LEAN CLAY (CL) (0.0 - 2.8) WITH SAND, DARK BROWNISH YELLOW TO RED, MOIST, CALCAREOUS, SOME ROOTS		JAR A	*** 72 HR CHECK AT 3.6' AND CAVED TO 6'. HOLE WAS OFFSET 12' EAST OF SURVEY STAKE.			
	2					TYPE                      ZONE AUGER                      0.0- 4.5 CORE                        4.5- 7.8			
	3		CLAY SAND (SC) (2.8 - 4.4) LIGHT YELLOWISH RED, MOIST		JAR B	SAMPLE                      DEPTH JAR A                        0.0- 2.8 JAR B                        2.8- 4.4 BOX 1                        4.5- 7.8			
978.4	4								
	5		SANDSTONE (SS) (4.4 - 7.8) YELLOWISH RED, DAMP, SOFT (RX CLASS), FINE BEDDING SEAMS, FEW SHALE LENSES AT 6.5', LIMESTONE LAYER AT 7.5'						
	6			100.0	BOX 1				
	7								
974.4	8		BOTTOM OF HOLE						
	9								
	10								

<b>DRILLING LOG</b>		DIVISION SOUTHWEST	INSTALLATION WICHITA 6, TX	SHEET 1		
1. PROJECT PLUM CREEK			10. SIZE AND TYPE OF BIT AUGER/CORE			
2. LOCATION (Coordinates or Station) 833300.00 1684300.00			11. DATUM FOR ELEVATION SHOWN (TBM or MSL) MSL			
3. DRILLING AGENCY USCE-F.T. WORTH			12. MANUFACTURER'S DESIGNATION OF DRILL FAILING 1500			
4. HOLE NO. (As shown on drawing title and file number) PT-16			13. OVERBURDEN SAMPLES DISTURBED 3    UNDISTURBED 0			
5. NAME OF DRILLER WILLIAMS			14. TOTAL NUMBER CORE BOXES 0			
6. DIRECTION OF HOLE <input checked="" type="checkbox"/> VERTICAL <input type="checkbox"/> INCLINED _____ DEG. FROM VERT.			15. ELEVATION GROUND WATER DRY HOLE			
7. THICKNESS OF OVERBURDEN 1.2			16. DATE HOLE STARTED 02/11/91    COMPLETED 02/11/91			
8. DEPTH DRILLED INTO ROCK 5.3			17. ELEVATION TOP OF HOLE 983.0			
9. TOTAL DEPTH OF HOLE 6.5			18. TOTAL CORE RECOVERY FOR BORING 99.0 %			
ROBERT McVEY						
ELEVATION a	DEPTH b	LEGEND c	CLASSIFICATION OF MATERIALS (Description) d	% CORE RECOVERY e	BOX OR SAMPLE NO. f	REMARKS (Drilling time, water loss, depth of weathering, etc., if significant) g
981.1	0		LEAN CLAY (CL) (0.0 - 1.2) SANDY, DARK REDDISH BROWN, MOIST, CALCAREOUS, ROOTS		JAR A	TYPE                  ZONE AUGER                  0.0- 2.0 AUGER                  2.0- 3.0 CORE                    3.0- 6.5  SAMPLE                  DEPTH JAR A                    0.0- 1.2 JAR B                    1.2- 1.9 JAR C                    1.9- 3.0 BOX 1                    3.0- 6.4
981.1	1		SANDSTONE (SS) (1.2 - 1.9) FINE GRAINED, WEAKLY CEMENTED, LIGHT GRAY, COARSE BEDDED, SOFT TO MOD. HARD (ROCK CLASSIFICATION)		JAR B	
	2		SANDSTONE (SS) (1.9 - 6.5) FINE, RED, THIN CLAY SEAMS INTERBEDDED, OTHERWISE AS ABOVE SS		JAR C	
	3		5.3-6.1 GRAY-GREEN SILTY SAND LENSES			
	4					
	5					
	6			99.0	BOX 1	
976.5	7		BOTTOM OF HOLE			
	8					
	9					
	10					

**APPENDIX B**  
**SWDED-GL REPORT NO. 15296**  
**FOUNDATION MATERIAL**



SOUTHWESTERN DIVISION LABORATORY, CORPS OF ENGINEERS  
4815 Cass Street  
Dallas, Texas 75235

SUBMITTAL OF SWDED-GL REPORT 15296 ( 38 pages)

PROJECT: PLUM CREEK : Contract No.  
Feature: FOUNDATION MATERIALS :

TEST REQUEST NO.: PN 91-25 : From: CHIEF  
Dated: 08 MAR 1991 : GEOTECHNICAL BRANCH  
Received: 22 MAR 1991 : TULSA DISTRICT

MATERIAL: DISTURBED AND UNDISTURBED SOIL SAMPLES  
No. and type of samples: 48 JARS, 25 CARTONS, 10 BOXES, AND 10 DB;S.  
Source or other identification: BORING PC-2 THROUGH PC-16.

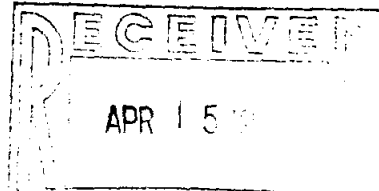

DATE RECEIVED: 10 AND 12 FEB 1991.

REMARKS: ALL TESTS HAVE BEEN PERFORMED IN ACCORDANCE WITH EM 1110-2-1906. SAMPLES WITH GRAIN SIZE DISTRIBUTION AND ATTERBERG LIMITS TESTS HAVE BEEN CLASSIFIED IN ACCORDANCE WITH MIL STD. 619B. ALL OTHER SAMPLES HAVE BEEN VISUALLY CLASSIFIED ONLY.

RESULTS OF TESTS	TABLE 1
PLASTICITY CHART	PLATE 1
MOISTURE CONTENT/DRY DENSITY VS DEPTH	PLATE 2
UNCONFINED COMPRESSION TESTS	PLATES 3-10
TRIAXIAL COMPRESSION TESTS, 1-PT Q-TYPE	PLATES 11-15
TRIAXIAL COMPRESSION TESTS, Q-TYPE	PLATES 16-19
TRIAXIAL COMPRESSION TESTS, R-TYPE	PLATES 20-22
DIRECT SHEAR TESTS	PLATES 23-25
CONSOLIDATION TEST	PLATES 26-28

Report sent to: : Copy furnished:  
TULSA DISTRICT :

Date: : Name and title: : Signature  
12 Apr 91 : WILLIAM R. TANNER : *William R. Tanner*  
: Director :  
: SWD Laboratory :

TABLE 1

## RESULTS OF TESTS OF DISTURBED AND UNDISTURBED SOIL SAMPLES

SWDED-6L REPORT NO. 15296, FLUM CREEK

BORING	NO.	SMD NO.	FLD NO.	DEPTH, FT	GR	SA	FI	LL	PL	PI	LS	WC, %	PCF	MAJOR TESTS	DESCRIPTION OF MATERIAL
PC	2	91/	96 JAR-A	0.0 - 1.2	1	59	40					13.8			- CLAYEY SAND, DARK REDDISH BROWN, MOIST, ROOTS.
PC	2	91/	97 JAR-B	1.2 - 4.5	1	37	62	31	16	15		15.6			CL - SANDY LEAN CLAY, LIGHT YELLOWISH RED TO BROWN, MOIST, ROOTS.
PC	2	91/	98 JAR-C	4.5 - 5.1	2	44	54					13.4			- SANDY LEAN CLAY, LIGHT YELLOWISH RED TO BROWN, MOIST, GRAVEL TO 3/4".
PC	2	91/	99 JAR-D	5.1 - 8.5	2	47	51	32	12	20		10.0			CL - SANDY LEAN CLAY, LIGHT YELLOWISH RED, MOIST, SCATTERED SMALL GRAVEL PARTICLES.
PC	2	91/	100 JAR-E	8.5 - 9.0	1	7	92					12.3			- LEAN CLAY, LIGHT YELLOWISH RED, MOIST, CALCAREOUS.
PC	2	91/	101 CTN-1	12.1 - 13.0	0	7	93	39	17	22		15.3			- SHALE, REDDISH BROWN, MOIST, SOFT (RX CLASS), FRACTURED, SCATTERED LIMESTONE POCKETS WITH WITH MODULES TO 3/8".
PC	2	91/	102 CTN-2	20.2 - 21.1	0	1	99					14.2			- SHALE, DARK REDDISH BROWN, MOIST, SOFT (RX CLASS), FRACTURED, GRAY-GREEN SANDY SILT POCKETS TO 1/2" SCATTERED THROUGHOUT.
PC	2	91/	103 CTN-3	25.7 - 26.6	0	39	61	29	14	15		7.7			- SHALE/SANDSTONE, DARK REDDISH BROWN, DAMP, SOFT (RX CLASS), GRAY-GREEN SANDY SILT POCKETS TO 1/4".
PC	2	91/	104 CTN-4	29.1 - 29.8	0	76	24					13.1			- SANDSTONE, DARK REDDISH BROWN, MOIST, SOFT (RX CLASS), FINE SHALE BEDDINGS THROUGHOUT, POCKETS OF GRAY-GREEN SILTY SAND.
PC	3	91/	16 JAR-A	0.0 - 1.5	0	63	37					13.8			- CLAYEY SAND, DARK BROWNISH RED, MOIST, SOME ROOTS.
PC	3	91/	17 JAR-B	1.5 - 3.8	0	42	58	32	15	17		16.5			CL - SANDY LEAN CLAY, LIGHT GRAYISH YELLOW TO RED, MOIST, FEW ROOTS.
PC	3	91/	19 JAR-D	3.3 - 10.0	4	21	75					12.1			- LEAN CLAY WITH SAND, LIGHT YELLOWISH RED, MOIST.
PC	3	91/	18 JAR-C	3.8 - 5.3	0	49	51					9.0			- SANDY LEAN CLAY, LIGHT GRAYISH YELLOW TO RED, MOIST, FEW ROOTS.

TABLE 1

## RESULTS OF TESTS OF DISTURBED AND UNDISTURBED SOIL SAMPLES

SMDSD-BL REPORT NO. 15296, PLUM CREEK

BORING	NO.	SMD NO.	FLD NO.	DEPTH, FT	GR	SA	FI	LL	PL	PI	LS	WC, %	PCF	MAJOR TESTS	DESCRIPTION OF MATERIAL
PC	3	91/ 20	CTN-1	13.1 - 14.0	0	3	97					14.9			- SHALE, REDDISH BROWN, MOIST, SOFT (RX CLASS), GRAY-GREEN SILTY SAND POCKETS THROUGHOUT, A FEW LIMESTONE GRAVELS TO 5/8".
PC	3	91/ 21	CTN-2	21.1 - 22.0	0	11	89	34	16	18		12.0			- SHALE, DARK REDDISH BROWN, MOIST, SOFT (RX CLASS), FRACTURED, GRAY-GREEN SANDSTONE SEAMS @ 21.5' AND IN BOTTOM 0.35', SANDSTONE SEAMS ARE CALCAREOUS.
PC	4	91/ 22	JAR-A	0.0 - 1.2	0	54	46					12.0			- CLAYEY SAND, DARK YELLOWISH BROWN, MOIST, SOME ROOTS.
PC	4	91/ 23	JAR-B	1.2 - 2.0	0	28	72	26	15	11		18.6			CL - LEAN CLAY WITH SAND, LIGHT YELLOWISH RED, MOIST, CALCAREOUS.
PC	4	91/ 24	JAR-C	2.0 - 7.0	2	62	36					12.4			- CLAYEY SAND, LIGHT YELLOWISH RED, MOIST, CALCAREOUS, GRAVEL TO 3/4".
PC	4	91/ 25	JAR-D	7.0 - 8.1	15	49	36	21	13	8		12.4			SC - CLAYEY SAND WITH GRAVEL, VERY DARK GRAYISH RED, MOIST, CALCAREOUS, GRAVEL TO 1/2".
PC	4	91/ 26	JAR-E	8.1 - 9.0	0	10	90					14.6			- FAT CLAY, LIGHT YELLOWISH RED, MOIST, CALCAREOUS.
PC	4	91/ 27	CTN-1	11.1 - 12.0	0	27	73	29	14	15		12.0			- SHALE/SANDSTONE, DARK REDDISH BROWN, MOIST, SOFT (RX CLASS), SMALL AMOUNT OF LIMESTONE SCATTERED THROUGHOUT.
PC	4	91/ 28	CTN-2	14.2 - 15.1	0	71	29					10.2			- SANDSTONE/SHALE, REDDISH BROWN, MOIST, SOFT (RX CLASS), NUMEROUS GRAY-GREEN SILTY SAND AREAS, FINE SHALE BEDDING SEAMS THROUGHOUT.
PC	4	91/ 29	CTN-3	23.2 - 24.2	0	76	24				0	13.9			- SANDSTONE, GRAY-GREEN AND REDDISH BROWN, MOIST, SOFT (RX CLASS), SMALL AMOUNT OF SHALE IN BEDDING SEAMS.
PC	5	91/ 30	JAR-A	0.0 - 2.0	0	13	87	37	15	22		19.3			CL - LEAN CLAY, DARK BROWNISH RED, MOIST.
PC	5	91/ 31	DB-1	2.0 - 2.9	0	11	89	33	14	19		19.1	107	TRIAX-Q, TRIAX-R, DS	CL - LEAN CLAY, DARK BROWN, MOIST, VERY STIFF, PENE = 3.25, 1/2" DIAMETER TREE ROOT.

TABLE 1

## RESULTS OF TESTS OF DISTURBED AND UNDISTURBED SOIL SAMPLES

SWDED-6L REPORT NO. 15296. PLUM CREEK

BORING	NO.	SWD NO.	FLD NO.	DEPTH, FT	GR	SA	FI	LL	PL	PI	LS	WC, %	PCF	MAJOR TESTS	DESCRIPTION OF MATERIAL
PC	5	91/	31 DB-1	2.9 - 4.0	1	33	66	26	13	13		14.4	110		CL - SANDY LEAN CLAY, BROWN, HARD, PENE > 4.0, MOIST, CALCAREOUS, FEW CALCAREOUS NODULES TO 1/2" SCATTERED, SAMPLE STUCK TO SIDE OF DB.
PC	5	91/	32 DB-2	4.0 - 6.0	2	23	75	33	14	19		17.4	107		CL - LEAN CLAY WITH SAND, BROWN, MOIST, HARD, PENE > 4.0, CALCAREOUS, SCATTERED CALCAREOUS NODULES TO 1/2", SCATTERED GRASS ROOTS, VERY SANDY IN TOP 0.3'.
PC	5	91/	33 DB-3	6.0 - 8.0	1	20	79	27	13	14		18.0	108	TRIAX-0, TRIAX-R, DS, CONSOLCL	CL - LEAN CLAY WITH SAND, BROWN AND REDDISH BROWN, MOIST, VERY STIFF, PENE = 2.75-3.25, CALCAREOUS, SCATTERED CALCAREOUS NODULES TO 1/2", VERY SANDY IN BOTTOM 0.8'.
PC	5	91/	34 DB-4	8.0 - 10.0	4	35	61	33	14	19		12.9	117		CL - SANDY LEAN CLAY, REDDISH BROWN, MOIST, VERY STIFF, PENE = 2.25-2.75, SCATTERED VERY SOFT SANDSTONE NODULES, GRAY-GREEN SILT POCKETS IN BOTTOM 1.0', SCATTERED CALCAREOUS NODULES, SHALY IN BOTTOM 1.0'.
PC	5	91/	35 DB-5	10.0 - 12.0	1	10	89	32	13	19		13.9	121	TRIAX-0	- SHALE, DARK RED, MOIST, HARD, PENE > 4.0, SOFT (RX CLASS), GRAY-GREEN SILT POCKETS SCATTERED THROUGHOUT, SANDY IN TOP 0.2', VERY SOFT SILTSTONE OR SANDSTONE IN BOTTOM 0.05'.
PC	5	91/	36 CTN-1	12.6 - 13.5	0	6	94	31	15	16		9.9	130	UC	- SHALE, DARK REDDISH BROWN, MOIST, SOFT (RX CLASS), BROKE ALONG GRAY-GREEN SILTY SAND SEAM @ 13.15', HIGHLY FRACTURED.
PC	5	91/	37 CTN-2	22.4 - 23.3	0	29	71	32	16	16		11.3	128	UC	- SANDSTONE, GRAY-GREEN, MOIST, SOFT (RX CLASS), SILTY, REDDISH BROWN SHALE SEAMS TO 1/2" IN TOP 0.33'.
PC	6	91/	38 JAR-A	0.0 - 0.8	0	29	71					21.6			- LEAN CLAY WITH SAND, DARK BROWNISH RED, MOIST, SOME ROOTS.
PC	6	91/	39 JAR-B	0.8 - 2.5	0	24	76	40	17	23		18.1			CL - LEAN CLAY WITH SAND, LIGHT BROWNISH RED, MOIST, ROOTS.
PC	6	91/	40 JAR-C	2.5 - 3.8	1	26	73					13.9			- LEAN CLAY WITH SAND, LIGHT YELLOWISH OLIVE WITH RED, MOIST, CALCAREOUS.

TABLE 1

## RESULTS OF TESTS OF DISTURBED AND UNDISTURBED SDIL SAMPLES

SWDED-GL REPORT NO. 15296, FLUM CREEK

BORING	NO.	SMD NO.	FLD NO.	DEPTH, FT	GR	SA	FI	LL	PL	PI	LS	WC, %	PCF	MAJOR TESTS	DESCRIPTION OF MATERIAL
PC	6	91/	41 JAR-D	3.8 - 7.0	0	26	74	55	18	37		14.2			CH - FAT CLAY WITH SAND, LIGHT YELLOWISH OLIVE WITH RED, MOIST.
PC	6	91/	42 JAR-E	7.0 - 11.5	0	61	39					8.2			- CLAYEY SAND, LIGHT YELLOWISH RED, MOIST, CALCAREOUS.
PC	6	91/	43 JAR-F	11.5 - 13.0	0	59	41	24	14	10		7.6			SC - CLAYEY SAND, LIGHT YELLOWISH RED, MOIST.
PC	6	91/	44 JAR-G	13.0 - 15.0	0	61	39					5.6			- CLAYEY SAND, LIGHT YELLOWISH RED, MOIST.
PC	6	91/	45 JAR-H	15.0 - 15.5	30	43	27	28	15	13		5.4			SC - CLAYEY SAND WITH GRAVEL, DARK RED, MOIST, CALCAREOUS, GRAVEL TO 3/8".
PC	6	91/	46 CTN-1	22.7 - 23.5	2	55	43					10.7			- SANDSTONE, LIGHT GRAY-GREEN, MOIST, SOFT (RX CLASS), SMALL AMOUNT OF SHALE IN BEDDING SEAMS.
PC	7	91/	47 JAR-A	0.0 - 1.2	0	45	55					18.0			- SANDY LEAN CLAY, DARK BROWNISH RED, MOIST, MANY ROOTS.
PC	7	91/	48 JAR-B	1.2 - 3.4	0	33	67					19.9			- SANDY LEAN CLAY, DARK RED, MOIST.
PC	7	91/	49 JAR-C	3.4 - 4.8	0	41	59	29	14	15		8.5			CL - SANDY LEAN CLAY, LIGHT YELLOWISH RED, MOIST, CALCAREOUS.
PC	7	91/	50 JAR-D	4.8 - 7.5	6	28	66					7.7			- SANDY LEAN CLAY, LIGHT YELLOWISH RED, MOIST, CALCAREOUS.
PC	7	91/	51 JAR-E	10.0 - 10.2	0	26	74	28	16	12		10.9			CL - LEAN CLAY WITH SAND, DARK RED, MOIST, CALCAREOUS.
PC	7	91/	52 CTN-1	12.6 - 13.3	0	7	93	32	15	17		9.9			- SHALE, REDDISH BROWN, DAMP, SOFT (RX CLASS), FRACTURED, GRAY-GREEN SILTY SAND POCKETS, SLIGHTLY CALCAREOUS.
PC	7	91/	53 CTN-2	21.3 - 22.2	0	12	88	34	16	18		9.7			- SHALE, DARK REDDISH BROWN, MOIST, SOFT (RX CLASS), SANDSTONE BEDDING SEAMS IN BOTTOM 0.4', BLACK IRON STAINED SEAMS, FRACTURED.
PC	7	91/	54 CTN-3	23.4 - 24.3	0	34	66					9.8			- SANDSTONE/SHALE, GRAY-GREEN AND REDDISH BROWN, MOIST, SOFT (RX CLASS), FINE BEDDING SEAMS THROUGHOUT.
PC	8	91/	55 JAR-A	0.0 - 2.0	0	36	64	36	19	17		18.9			CL - SANDY LEAN CLAY, DARK BROWNISH RED, MOIST, ROOTS.

TABLE 1

## RESULTS OF TESTS OF DISTURBED AND UNDISTURBED SOIL SAMPLES

SWDED-GL REPORT NO. 15296. PLUM CREEK.

BORING	NO.	SWD NO.	FLD NO.	DEPTH, FT	GR	SA	FI	LL	PL	PI	LS	WC, %	PCF	MAJOR TESTS	DESCRIPTION OF MATERIAL
PC	B	91/	56 DB-1	2.0 - 4.0	2	31	67	27	13	14		15.4	115		CL - SANDY LEAN CLAY, REDDISH BROWN, MOIST, VERY STIFF, PENE = 2.75, CALCAREOUS, NUMEROUS CALCAREOUS NODULES TO 1' THROUGHOUT, SCATTERED SAND POCKETS, TOP 0.2' IS VERY SOFT WITH ROOTS THROUGHOUT.
PC	B	91/	57 DB-2	4.0 - 6.0	2	37	61	31	15	16		14.4	116		CL - SANDY LEAN CLAY, REDDISH BROWN, MOIST, VERY STIFF, PENE = 3.75, CALCAREOUS, NUMEROUS CALCAREOUS NODULES, SCATTERED SAND POCKETS, SEAMS AND LENSES, ROOTS IN TOP 0.4', SAMPLE SEPERATES EASILY ALONG SAND SEAMS.
PC	B	91/	58 DB-3	6.0 - 8.0	0	36	64	31	15	16		13.6	114		CL - SANDY LEAN CLAY, BROWN, MOIST, HARD, PENE > 4.0, CALCAREOUS, NUMEROUS CALCAREOUS NODULES, SAND POCKETS, SEAMS, AND LENSES.
PC	B	91/	59 DB-4	8.0 - 10.0	1	48	51	26	14	12		14.1	111	TRIAx-Q, TRIAX-R, DS	CL - SANDY LEAN CLAY, BROWN, MOIST, HARD, PENE > 4.0, SAND POCKETS, SEAMS AND LENSES, SCATTERED CALCAREOUS NODULES.
PC	B	91/	60 DB-5	10.0 - 12.0								16.1	107		- SILTY SAND/SANDSTONE, DARK RED AND OLIVE YELLOW, VERY MOIST, SOFT, PENE = 1.5, ALTERNATING LAYERS OF SOFT SANDSTONE AND SAND, SOME SHALE WITH LAYERS OF SANDSTONE, EASILY BROKEN, WATERWASHED.
PC	B	91/	61 CTN-1	14.2 - 15.0	0	63	37					12.7	122	UC	- SANDSTONE, LIGHT OLIVE BROWN AND GRAY-GREEN, MOIST, SOFT (RX CLASS), SAMPLE TWISTED FROM DRILL ACTION.
PC	B	91/	62 CTN-2	19.3 - 20.2	0	66	34					9.8	126	UC	- SANDSTONE, BLUE-GRAY, MOIST, SOFT (RX CLASS), HORIZONTAL SPLIT @ 19.95' ALONG 1/2" SHALE SEAM FINE SHALE BEDDING SEAMS.
PC	9	91/	63 JAR-A	0.0 - 1.7	1	34	65					16.9			- SANDY LEAN CLAY, LIGHT YELLOWISH RED, MOIST, SOME ROOTS.
PC	9	91/	64 JAR-B	1.7 - 2.4	1	25	74	25	15	10		10.8			CL - LEAN CLAY WITH SAND, LIGHT YELLOWISH RED WITH BROWN, MOIST, CALCAREOUS.
PC	9	91/	65 JAR-C	2.4 - 6.6	0	34	66					9.5			- SANDY LEAN CLAY, VERY LIGHT YELLOWISH RED TO BROWN, MOIST, CALCAREOUS.

## RESULTS OF TESTS OF DISTURBED AND UNDISTURBED SOIL SAMPLES

SWDEI-GL REPORT NO. 15296, FLUM CREEK

BORING	NO.	SWD NO.	FLD NO.	DEPTH, FT	GR	SA	FI	LL	PL	PI	LS	WC, %	PCF	MAJOR TESTS	DESCRIPTION OF MATERIAL
PC	9	91/ 66	CTN-1	7.8 - 8.6	1	33	66	30	13	17		11.5			- SHALE, REDDISH BROWN, MOIST, HARD, PENE > 4.0, SOFT (RX CLASS), LIGHT OLIVE YELLOW, SILTY SAND SEAM 0.15' THICK @ 8.1', DARK REDDISH BROWN SANDSTONE W/TWIN SHALE SEAMS IN BOTTOM 0.35'.
PC	9	91/ 67	CTN-2	13.1 - 14.0								13.3	119	UC	- SANDSTONE, LIGHT OLIVE BROWN, MOIST, SOFT (RX CLASS), MOTTLED WITH BLACK SPECKS IN TOP 0.25'.
PC	9	91/ 68	CTN-3	24.0 - 22.0								11.1	129	UC	- SANDSTONE, BLUE-GREEN AND REDDISH BROWN, MOIST, SOFT (RX CLASS), THIN SHALE SEAMS.
PC	10	91/ 69	JAR-A	0.0 - 3.0	1	35	64					20.8			- SANDY LEAN CLAY, LIGHT YELLOWISH RED, MOIST, CALCAREOUS, SOME ROOTS.
PC	10	91/ 70	JAR-B	3.0 - 5.5				42	18	24		10.2			- LEAN CLAY WITH SAND, VERY LIGHT GRAYISH RED, MOIST, SOME ROOTS, APPEARS TO BE SHALE.
PC	10	91/ 71	CTN-1	6.4 - 7.3				39	16	23				TQ-1PT	- SHALE, DARK RED, DAMP, SOFT (RX CLASS), HIGHLY FRACTURED, SLICKENSIDED, LIGHT GRAY-GREEN, SILTY SAND LENSES @ 7.0' AND 7.3'.
PC	10	91/ 72	CTN-2	13.1 - 14.0								11.9			- SHALE, DARK RED, MOIST, SOFT (RX CLASS), FRACTURED, SLICKENSIDED, SOME GRAY-GREEN SILT SPECKS THROUGHOUT.
PC	10	91/ 73	CTN-3	20.2 - 21.1								10.1			- SHALE, DARK RED, MOIST, SOFT (RX CLASS), GRAY-GREEN SILTY SANDSTONE LAYER @ 20.55'-20.7', SMALL POCKETS OF SILTY SANDSTONE THROUGHOUT.
PC	10	91/ 74	CTN-4	22.5 - 23.3								9.2			- SANDSTONE, ARGILLACEOUS, DARK RED, MOIST, SOFT (RX CLASS), SOME GRAY-GREEN SILTY SAND LENSES IN BOTTOM.
PC	11	91/ 75	JAR-A	0.0 - 0.9	35	32	33					12.1			- CLAYEY GRAVEL WITH SAND, DARK REDDISH BROWN, MOIST, GRAVEL TO 1/2".
PC	11	91/ 76	JAR-B	0.9 - 3.0	0	79	21					10.8			- CLAYEY SAND, DARK REDDISH BROWN, MOIST, SHALE BEDDING.
PC	11	91/ 77	BOX-1	5.5 - 9.4								0.8			- SANDSTONE, REDDISH BROWN, DRY, MODERATELY HARD (RX CLASS), THIN BEDDING SEAMS, THIN SHALE SEAMS

## RESULTS OF TESTS OF DISTURBED AND UNDISTURBED SOIL SAMPLES

SND-6L REPORT NO. 15296, PLUM CREEK

BORING	NO.	SND NO.	FLD NO.	DEPTH, FT	GR	SA	F1	LL	PL	P1	LS	WC, %	PCF	MAJOR TESTS	DESCRIPTION OF MATERIAL
															IN TOP 0.9', CHEESE CLOTH NOT SEALED GOOD WITH WAX FROM 9.0-9.4.
PC	11	91/	77 BOX-1	9.4 - 13											- SANDSTONE, LIGHT OLIVE YELLOW, DRY, SOFT (RX CLASS), THIN BEDDING SEAMS, BOTTOM SECTION IS SANDY SHALE, LIGHT OLIVE BROWN, MOIST, AND SOFT (RX CLASS).
PC	11	91/	78 BOX-2	13.0 - 17.0	0	3	97	55	26	29		16.2	118	TQ-1PT	- SHALE, REDDISH BROWN, DAMP TO MOIST, SOFT (RX CLASS), TOP 0.5' LIGHT OLIVE BROWN, HIGHLY FRACTURED LIGHT OLIVE BROWN AND OLIVE YELLOW MOTTLED THROUGHOUT.
PC	11	91/	79 BOX-3	18.5 - 20.0								8.4			- SHALE, REDDISH BROWN AND LIGHT GRAYISH BROWN, DAMP, SOFT (RX CLASS), BOTTOM 0.3' IS DRY AND CRACKED.
PC	11	91/	79 BOX-3	20.0 - 23.4											- SHALE, REDDISH BROWN, DAMP, SOFT (RX CLASS), GRAY-GREEN SANDY SILT POCKETS 1/4" TO 1 1/4" IN DIAMETER SCATTERED THROUGHOUT.
PC	12	91/	80 JAR-A	0.0 - 1.0	1	44	55					20.9			- SANDY LEAN CLAY, DARK REDDISH BROWN, MOIST, SOME ROOTS.
PC	12	91/	81 JAR-B	1.0 - 5.0	52	34	14					11.0			- CLAYEY GRAVEL WITH SAND, LIGHT YELLOWISH RED, MOIST.
PC	12	91/	82 BOX-1	5.0 - 9.0								4.7			- SANDSTONE, REDDISH BROWN, TO DARK RED, MOIST, SOFT (RX CLASS), THIN SHALY SEAMS THROUGHOUT, SAMPLE BADLY DISTURBED, NUMEROUS SMALL CHUNKS, COLOR CHANGES TO LIGHT OLIVE BROWN @ 7.5'.
PC	12	91/	83 BOX-2	9.3 - 10.5	7	17	76	44	16	28		12.5	124		- SANDSTONE/WEATHERED SHALE, REDDISH BROWN AND LIGHT OLIVE BROWN, MOIST, HARD, PENE > 4.0, THIN SHALE AND ALTERNATING SAND AND SANDSTONE SEAMS, CALCAREOUS.
PC	12	91/	83 BOX-2	10.5 - 12.3								13.2	124	TQ-1PT	- SHALE, WEATHERED, LIGHT OLIVE BROWN, MOIST, SOFT (RX CLASS), SOME LIGHT GRAY CLAY MOTTLED THROUGHOUT, GRAVELS TO 1/2", CALCAREOUS.



RESULTS OF TESTS OF DISTURBED AND UNDISTURBED SOIL SAMPLES

SWDED-GL REPORT NO. 15296, PLUM CREEK

BORING NO.	NO.	SWD NO.	FLD NO.	DEPTH, FT	BR	SA	FI	LL	PL	PI	LS	WC, %	PCF	MAJOR TESTS	DESCRIPTION OF MATERIAL
PC	12	91/	B3	BDX-2	12.3	-	-	-	-	-	-	-	-	-	- SANDSTONE/SHALE, LIGHT GRAY TO REDDISH BROWN, DAMP TO MOIST, ALTERNATING SEAMS, DRILL DISTURBANCE IN BOTTOM 1.0'.
PC	12	91/	B4	BDX-3	14.3	-	-	-	-	-	-	12.3	-	-	- SHALE, REDDISH BROWN, MOIST, SOFT (RX CLASS), LIGHT BROWNISH GRAY MOTTLED THROUGHOUT, SAMPLE DISTURBED FROM DRILL ACTION, TOP 0.5' IS DRY AND CRACKED.
PC	12	91/	B4	BDX-3	16.8	-	-	-	-	-	-	-	-	-	- SHALE, REDDISH BROWN, MOTTLED WITH LIGHT BROWNISH GRAY, DRY, SOFT (RX CLASS).
PC	12	91/	B5	BDX-4	17.4	-	-	-	-	-	-	14.4	-	-	- SHALE, REDDISH BROWN WITH SOME LIGHT GRAY, MOIST, SOFT (RX CLASS), SPIRAL GROVE FROM DRILLING ACTION.
PC	13	91/	B6	JAR-A	0.0	2	54	44	-	-	-	15.9	-	-	- CLAYEY SAND, DARK BROWNISH RED, MOIST.
PC	13	91/	B7	JAR-B	1.4	1	32	67	54	17	37	21.8	-	-	CH - SANDY FAT CLAY, LIGHT YELLOWISH BROWN, MOIST.
PC	13	91/	B8	JAR-C	3.3	0	31	69	-	-	-	11.5	-	-	- SANDY FAT CLAY, LIGHT YELLOWISH RED, MOIST, CALCAREOUS.
PC	13	91/	B9	CTN-1	9.7	0	4	96	-	-	-	9.2	134	TQ-1PT	- SHALE, DARK RED, MOIST, SOFT (RX CLASS), GRAY-GREEN SILTY SAND POCKETS TO 3/4", HIGHLY FRACTURED, SLICKENSIDED.
PC	14	91/	90	JAR-A	0.0	0	34	66	-	-	-	24.4	-	-	- SANDY LEAN CLAY, DARK BROWNISH RED, MOIST, ROOTS.
PC	14	91/	91	JAR-B	1.2	1	36	63	23	13	10	12.3	-	-	CL - SANDY LEAN CLAY, LIGHT YELLOWISH RED, MOIST.
PC	14	91/	92	BDX-1	5.5	0	26	74	-	-	-	10.1	133	TQ-1PT	- SANDSTONE, DARK REDDISH BROWN, MOIST, SOFT (RX CLASS), THIN ALTERNATING SHALE SEAMS THROUGHOUT, FEW SHALE LAYERS TO 1/2" SCATTERED THROUGHOUT.
PC	15	91/	93	JAR-A	0.0	0	27	73	-	-	-	17.9	-	-	- LEAN CLAY WITH SAND, DARK BROWNISH YELLOW TO RED, MOIST, CALCAREOUS, SOME ROOTS.
PC	15	91/	94	JAR-B	2.8	0	60	40	-	-	-	11.9	-	-	- CLAYEY SAND, LIGHT YELLOWISH RED, MOIST.

RESULTS OF TESTS OF DISTURBED AND UNDISTURBED SOIL SAMPLES

SMDED-GL REPORT NO. 15296, PLUM CREEK

BORING	NO.	SMD NO.	FLO NO.	DEPTH, FT	GR	SA	FI	LL	PL	PI	LS	WC, %	PCF	MAJOR TESTS	DESCRIPTION OF MATERIAL
PC	15	91/	95 BDX-1	4.5 - 7.8	0	64	36				0	7.1	126	UC	- SANDSTONE, YELLOWISH RED, DAMP, SOFT (RX CLASS), FINE BEDDING SEAMS, FEW SHALE LENSES @ 6.5', Limestone layer 0.15' thick @ 7.5'.
PC	16	91/	105 JAR-A	0.0 - 1.2	0	39	61					18.5			- SANDY LEAN CLAY, DARK REDDISH BROWN, MOIST, CALCAREOUS, ROOTS.
PC	16	91/	106 JAR-B	1.2 - 1.9	0	74	26					10.8			- CLAYEY SAND/SANDSTONE, VERY LIGHT OLIVE YELLOW, MOIST, CALCAREOUS.
PC	16	91/	107 JAR-C	1.9 - 3.0	0	67	33					9.8			- CLAYEY SAND, DARK REDDISH BROWN, MOIST, CALCAREOUS.
PC	16	91/	106 BDX-1	3.0 - 7.6	0	77	23					10.2	124	UC	- SANDSTONE, DARK REDDISH BROWN AND DARK RED, MOIST, SOFT (RX CLASS), SOME SHALE @ 5.5'-5.8' AND 6.1'-6.3', BOTTOM 1.0' IS MODERATELY HARD, TOP 1.5' OF SAMPLE SPLIT AND BROKEN ALONG BEDDING SEAMS, GRAY-GREEN SILTY SAND LENSES @ 5.3'-6.1'.

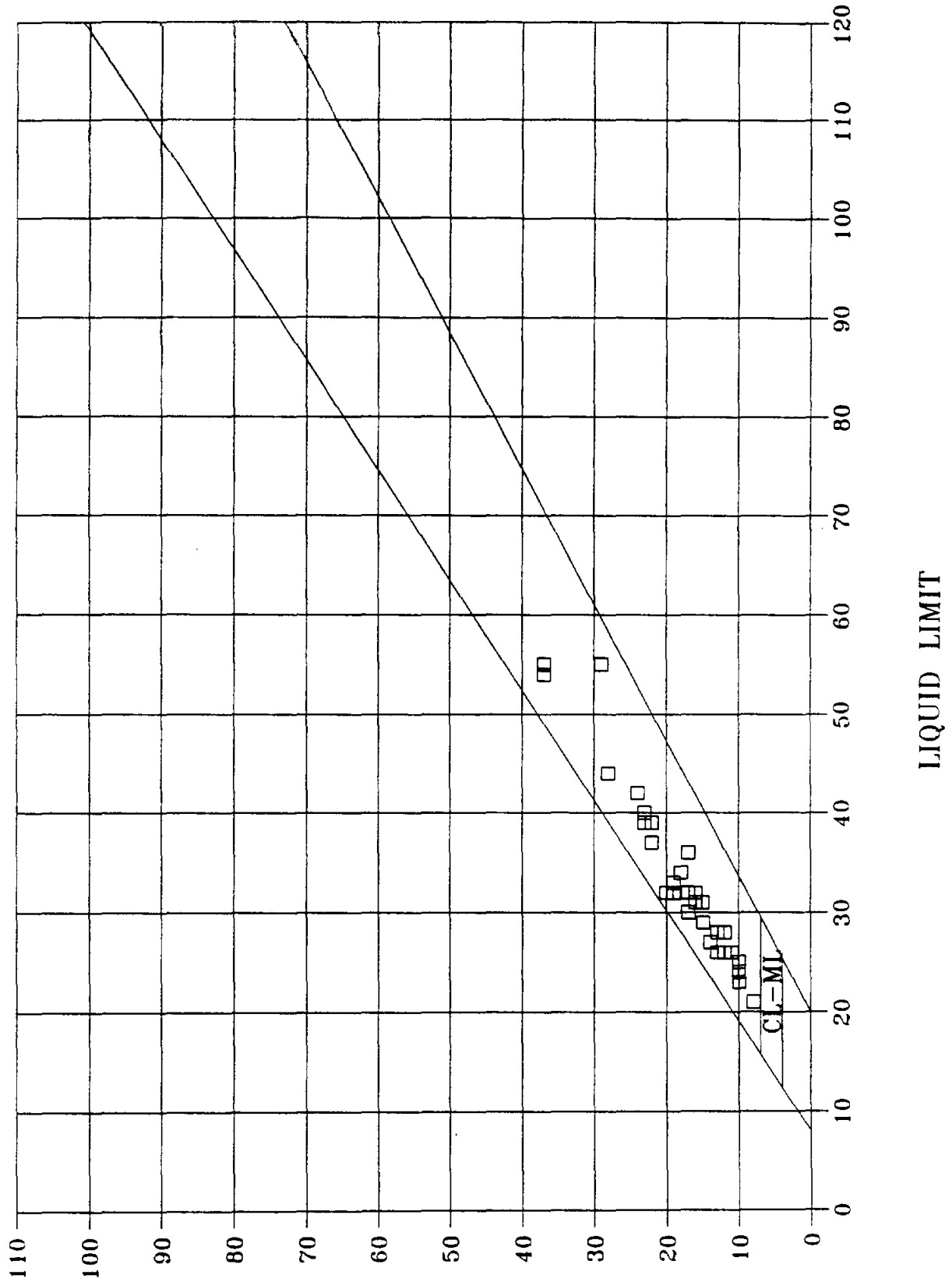

PLASTIC INDEX

PLUM CREEK  
 FOUNDATION MATERIALS  
 PLASTICITY CHART

CESWD-ED-GL RPT NO. 15296

PLATE #

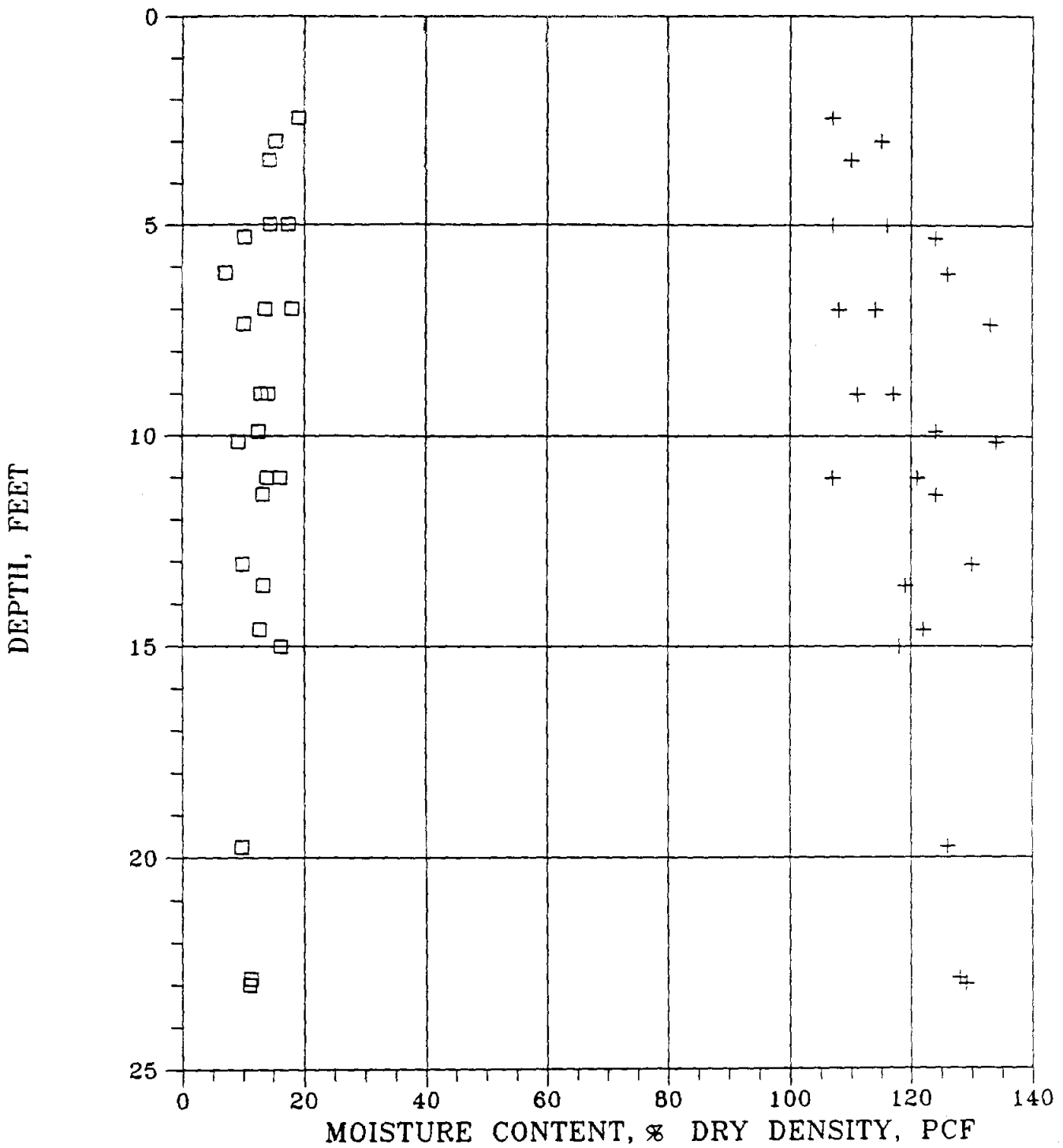

□□□□ MC  
 ++++++ DRY DENSITY

PLUM CREEK  
 FOUNDATION MATERIALS  
 MOISTURE CONTENT AND  
 DRY DENSITY VS DEPTH  
 PLATE #

## UNCONFINED COMPRESSION TEST

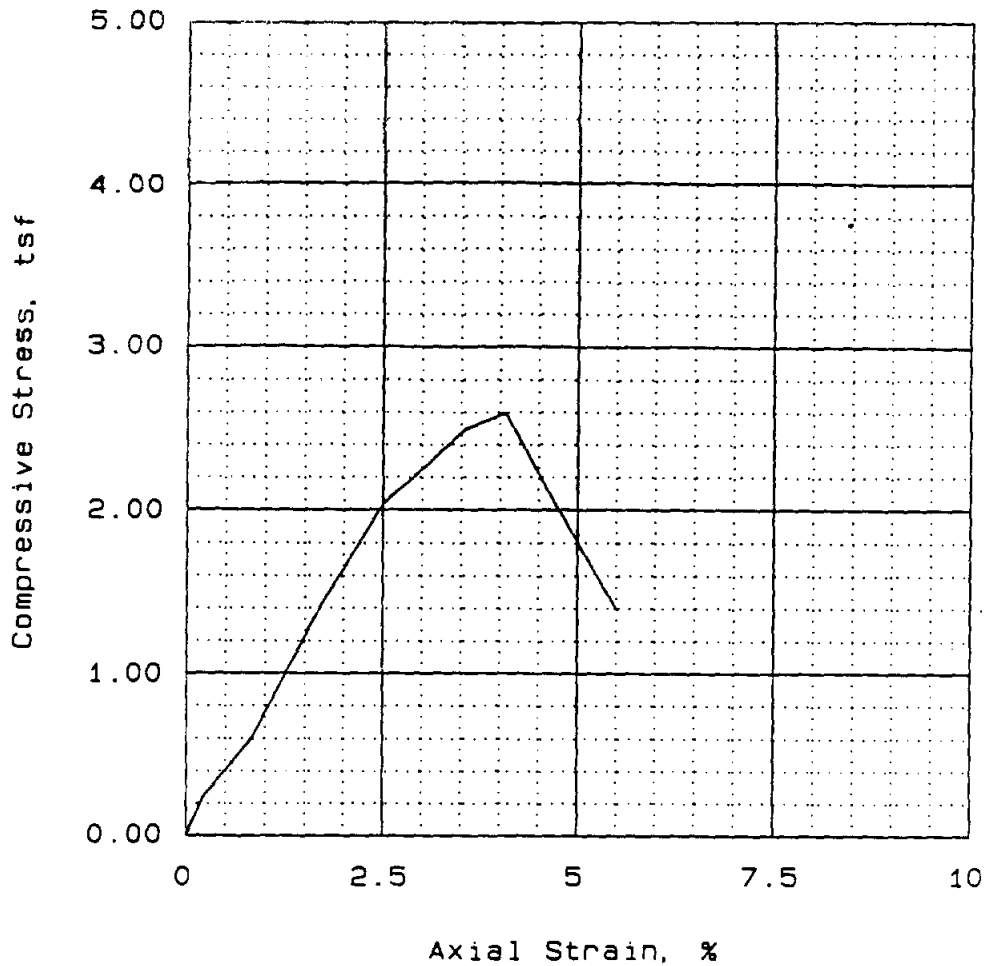

Sample number:	1			
Unconfined strength, tsf	2.60			
Undrained shear strength, tsf	1.30			
Rate of strain, %/min	0.820			
Water content, %	11.8			
Void ratio	0.3417			
Saturation, %	92.9			
Dry density, pcf	124.7			
Specimen diameter, in	3.85			
Specimen height, in	6.65			

Description: LEAN CLAY (CL)  
 LL = 31    PL = 15    PI = 16.0    GS = 2.68    Type: UNDISTURBED

Project No.: 15296 Date: MARCH 1991 Remarks: SPECIFIC GRAVITY ESTIMATED Fig No.	Client: US ARMY CORPS OF ENGINEERS TULSA DISTRICT Project: PLUM CREEK FOUNDATION MATERIALS Location: PC-5, CTN-1 12.6-13.15, SWD-LAB NO. 91/36 UNCONFINED COMPRESSION TEST CORPS OF ENGINEERS - SOUTHWESTERN
--	---

# UNCONFINED COMPRESSION TEST

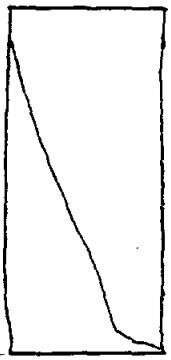
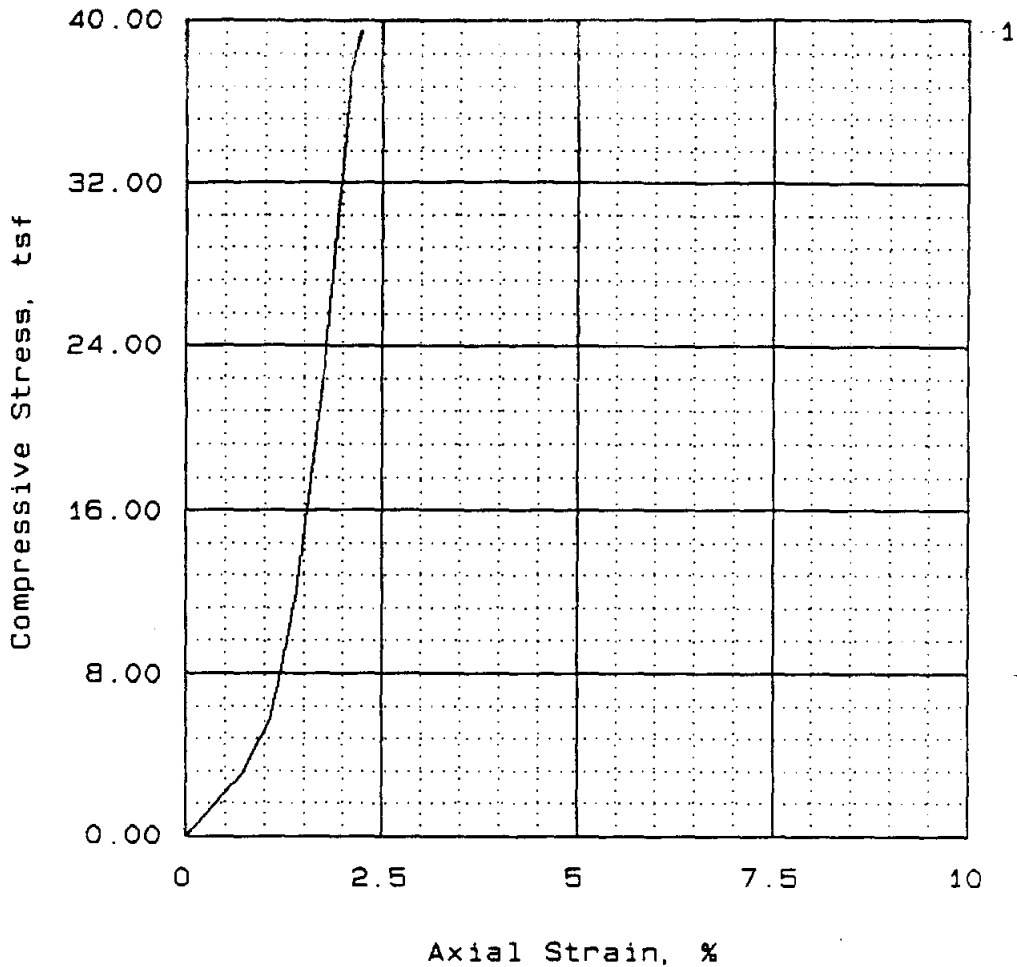

Sample number:	1			
Unconfined strength, tsf	39.54			
Undrained shear strength, tsf	19.77			
Rate of strain, %/min	0.190			
Water content, %	8.9			
Void ratio	0.2782			
Saturation, %	86.8			
Dry density, pcf	132.4			
Specimen diameter, in	3.70			
Specimen height, in	8.31			

Description: SANDSTONE

LL =      PL =      PI =      GS = 2.71      Type: UNDISTURBED

Project No.: 15296

Date: MARCH 1991

Remarks:

SPECIFIC GRAVITY

ESTIMATED

Client: US ARMY CORPS OF ENGINEERS

TULSA DISTRICT

Project: PLUM CREEK

FOUNDATION MATERIALS

Location: PC-5, CTN-2

22.6-23.3, SWD-LAB NO. 91/37

UNCONFINED COMPRESSION TEST

CORPS OF ENGINEERS - SOUTHWESTERN

Fig No.

# UNCONFINED COMPRESSION TEST

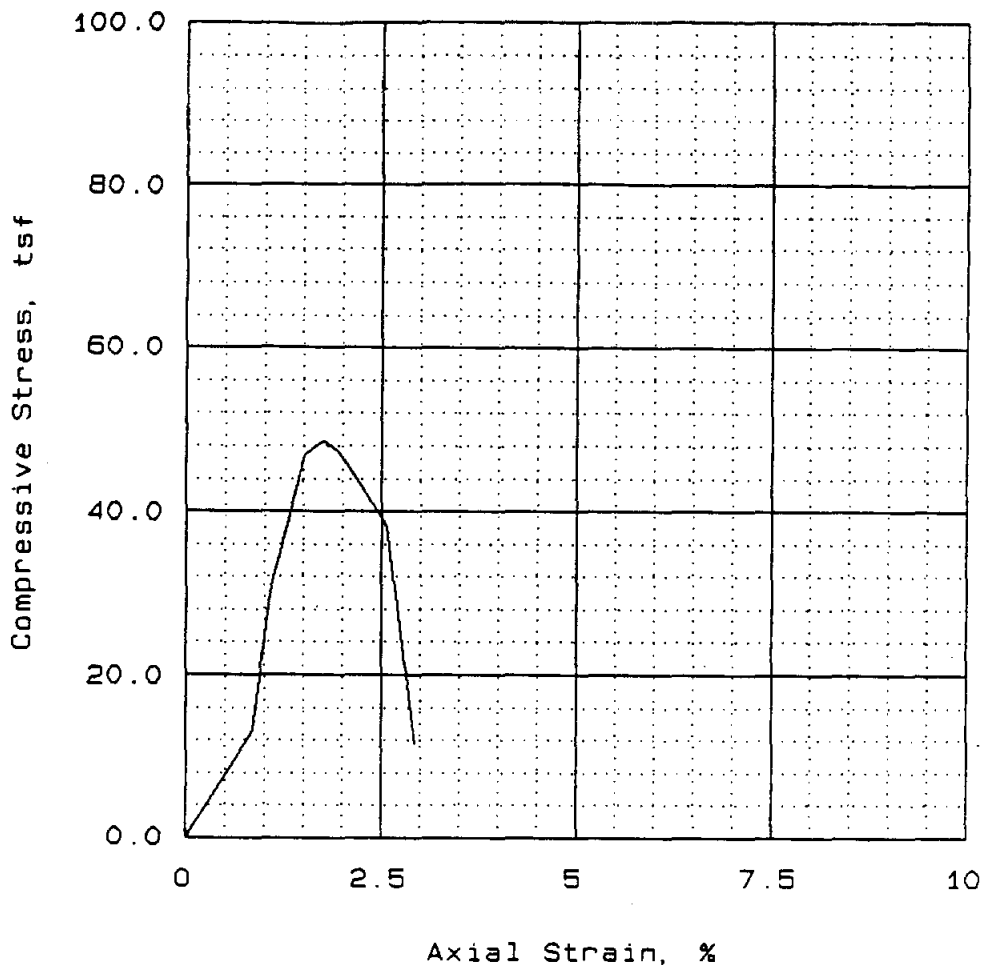

Sample number:	1			
Unconfined strength, tsf	48.7			
Undrained shear strength, tsf	24.3			
Rate of strain, %/min	0.140			
Water content, %	9.2			
Void ratio	0.3032			
Saturation, %	81.0			
Dry density, pcf	127.9			
Specimen diameter, in	3.80			
Specimen height, in	6.90			

Description: SANDSTONE

LL =      PL =      PI =      GS = 2.71      Type: UNDISTURBED

Project No.: 15296

Date: MARCH 1991

Remarks:

SPECIFIC GRAVITY

ESTIMATED

Client: US ARMY CORPS OF ENGINEERS

TULSA DISTRICT

Project: PLUM CREEK

FOUNDATION MATERIALS

Location: PC-8, CTN-1

14.4-15.0, SWD-LAB NO. 91/61

UNCONFINED COMPRESSION TEST

CORPS OF ENGINEERS - SOUTHWESTERN

Fig No.

# UNCONFINED COMPRESSION TEST

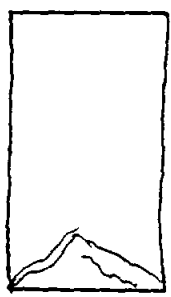
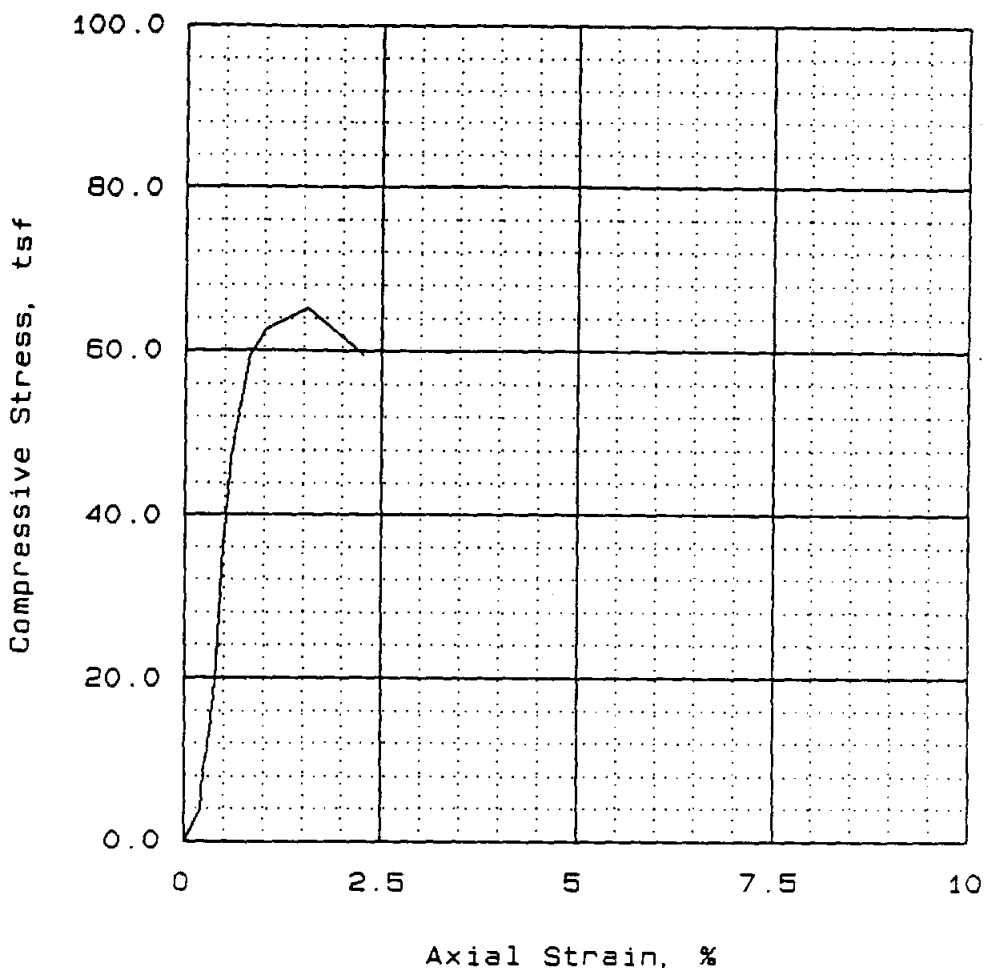

Sample number:	1			
Unconfined strength, tsf	65.2			
Undrained shear strength, tsf	32.6			
Rate of strain, %/min	0.130			
Water content, %	9.8			
Void ratio	0.3149			
Saturation, %	84.6			
Dry density, pcf	128.7			
Specimen diameter, in	3.75			
Specimen height, in	6.81			

Description: SANDSTONE

LL =	PL =	PI =	GS = 2.71	Type: UNDISTURBED
------	------	------	-----------	-------------------

<p>Project No.: 15296                  Date: MARCH 1991                  Remarks:                  SPECIFIC GRAVITY                  ESTIMATED</p>	<p>Client: US ARMY CORPS OF ENGINEERS                  TULSA DISTRICT                  Project: PLUM CREEK                  FOUNDATION MATERIALS                  Location: PC-8, CTN-2                  19.3-19.9, SWD-LAB NO. 91/62</p> <p style="text-align: center;">UNCONFINED COMPRESSION TEST                  CORPS OF ENGINEERS - SOUTHWESTERN</p>
--	---

Fig No. \_\_\_\_\_



# UNCONFINED COMPRESSION TEST

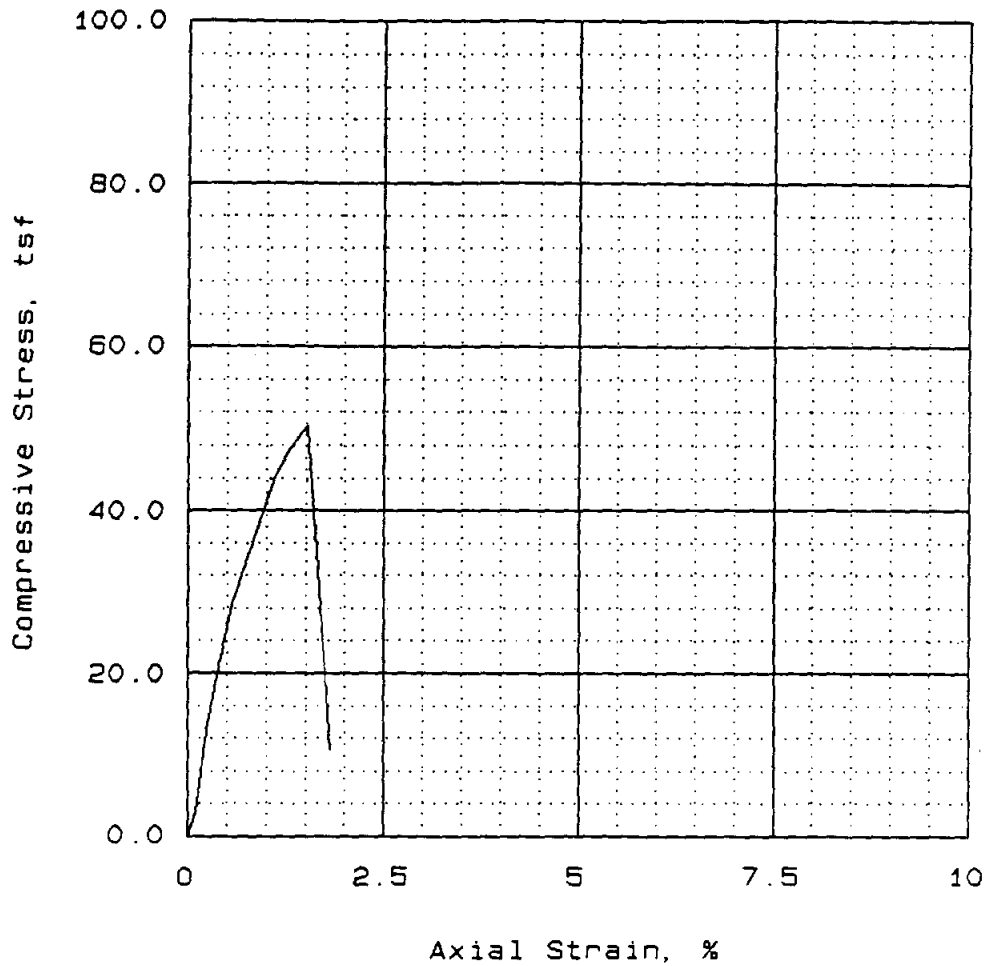

1

Sample number:	1			
Unconfined strength, tsf	50.3			
Undrained shear strength, tsf	25.1			
Rate of strain, %/min	0.100			
Water content, %	13.3			
Void ratio	0.4267			
Saturation, %	84.5			
Dry density, pcf	118.6			
Specimen diameter, in	3.80			
Specimen height, in	9.49			

Description: SANDSTONE

LL =      PL =      PI =      GS = 2.71      Type: UNDISTURBED

Project No.: 15296  
 Date: MARCH 1991  
 Remarks:  
 SPECIFIC GRAVITY  
 ESTIMATED

Fig No.

Client: US ARMY CORPS OF ENGINEERS  
 TULSA DISTRICT  
 Project: PLUM CREEK  
 FOUNDATION MATERIALS  
 Location: PC-9, CTN-2  
 13.1-14.0, SWD-LAB NO. 91/67

UNCONFINED COMPRESSION TEST  
 CORPS OF ENGINEERS - SOUTHWESTERN

# UNCONFINED COMPRESSION TEST

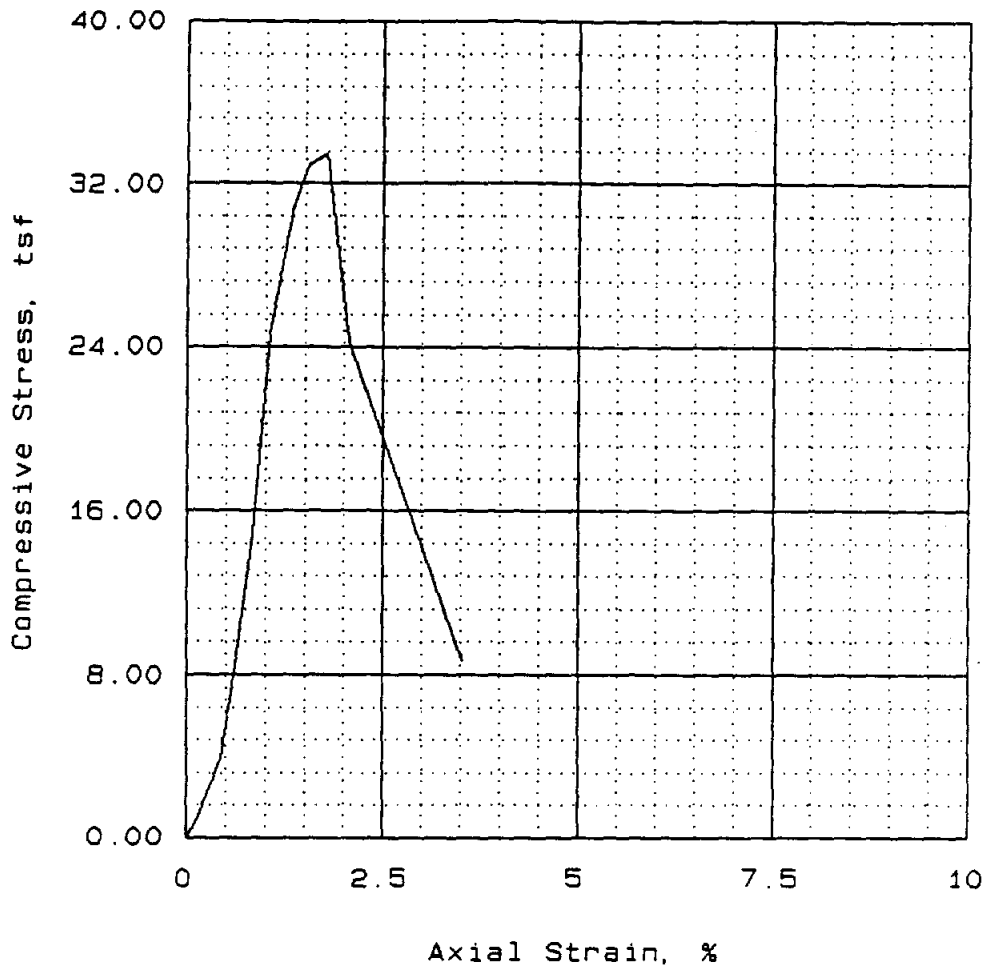

Sample number:	1			
Unconfined strength, tsf	33.45			
Undrained shear strength, tsf	16.72			
Rate of strain, %/min	0.190			
Water content, %	11.1			
Void ratio	0.3103			
Saturation, %	97.1			
Dry density, pcf	129.1			
Specimen diameter, in	3.77			
Specimen height, in	6.82			

Description: SANDSTONE

LL =	PL =	PI =	GS = 2.71	Type: UNDISTURBED
------	------	------	-----------	-------------------

Project No.: 15296  
 Date: MARCH 1991  
 Remarks:  
 SPECIFIC GRAVITY  
 ESTIMATED

Fig No.

Client: US ARMY CORPS OF ENGINEERS  
 TULSA DISTRICT  
 Project: PLUM CREEK  
 FOUNDATION MATERIALS  
 Location: PC-9, CTN-3  
 21.4-22.0, SWD-LAB NO. 91/68

UNCONFINED COMPRESSION TEST  
 CORPS OF ENGINEERS - SOUTHWESTERN

# UNCONFINED COMPRESSION TEST

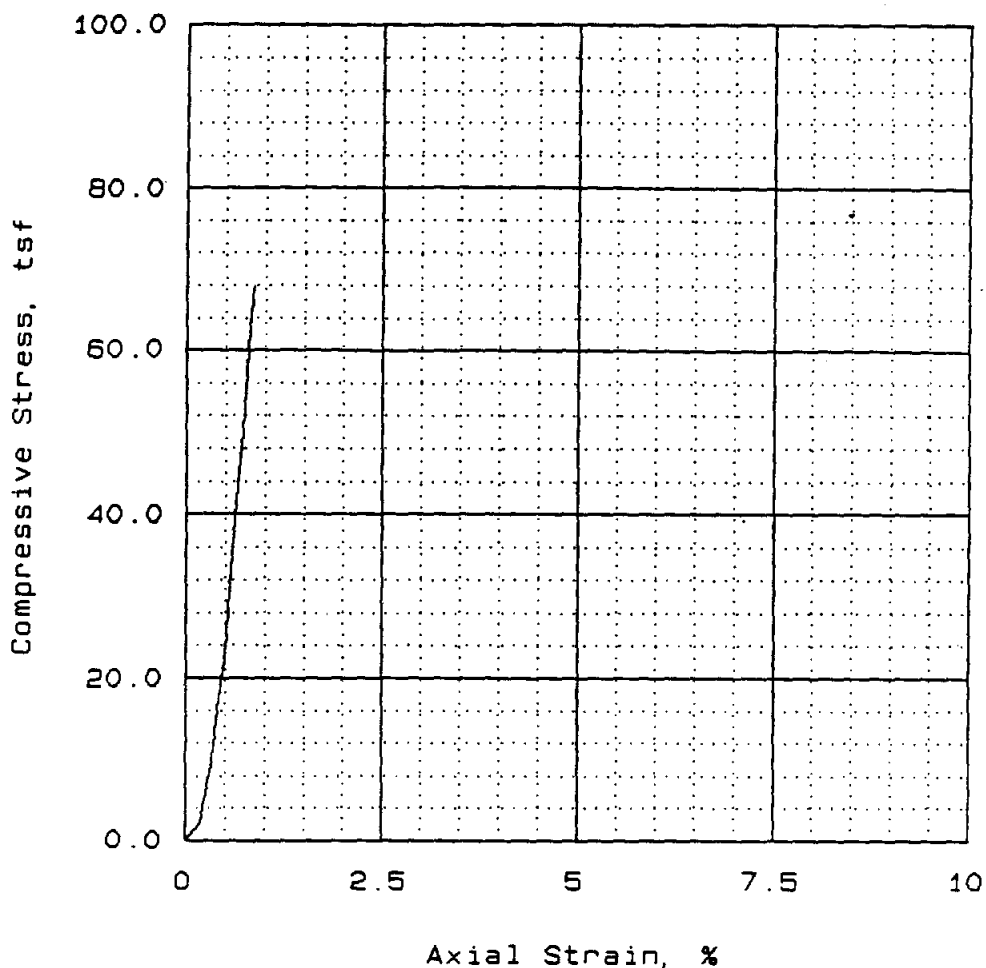

Sample number:	1			
Unconfined strength, tsf	67.9			
Undrained shear strength, tsf	34.0			
Rate of strain, %/min	0.040			
Water content, %	6.1			
Void ratio	0.3102			
Saturation, %	52.3			
Dry density, pcf	127.7			
Specimen diameter, in	3.77			
Specimen height, in	7.21			

Description: SANDSTONE WITH THIN CLAYSHALE LENSES

LL =      PL =      PI =      GS = 2.68      Type: UNDISTURBED

Project No.: 15296

Date: APRIL 1991

Remarks:

SPECIFIC GRAVITY

ESTIMATED

Client: US ARMY CORPS OF ENGINEERS

TULSA DISTRICT

Project: PLUM CREEK

FOUNDATION MATERIALS

Location: BORING: PC-15, BOX-1

5.7-6.4, SWD LAB NO. 91/95

UNCONFINED COMPRESSION TEST

CORPS OF ENGINEERS - SOUTHWESTERN

Fig No.

# UNCONFINED COMPRESSION TEST

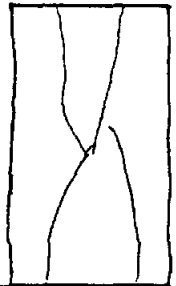
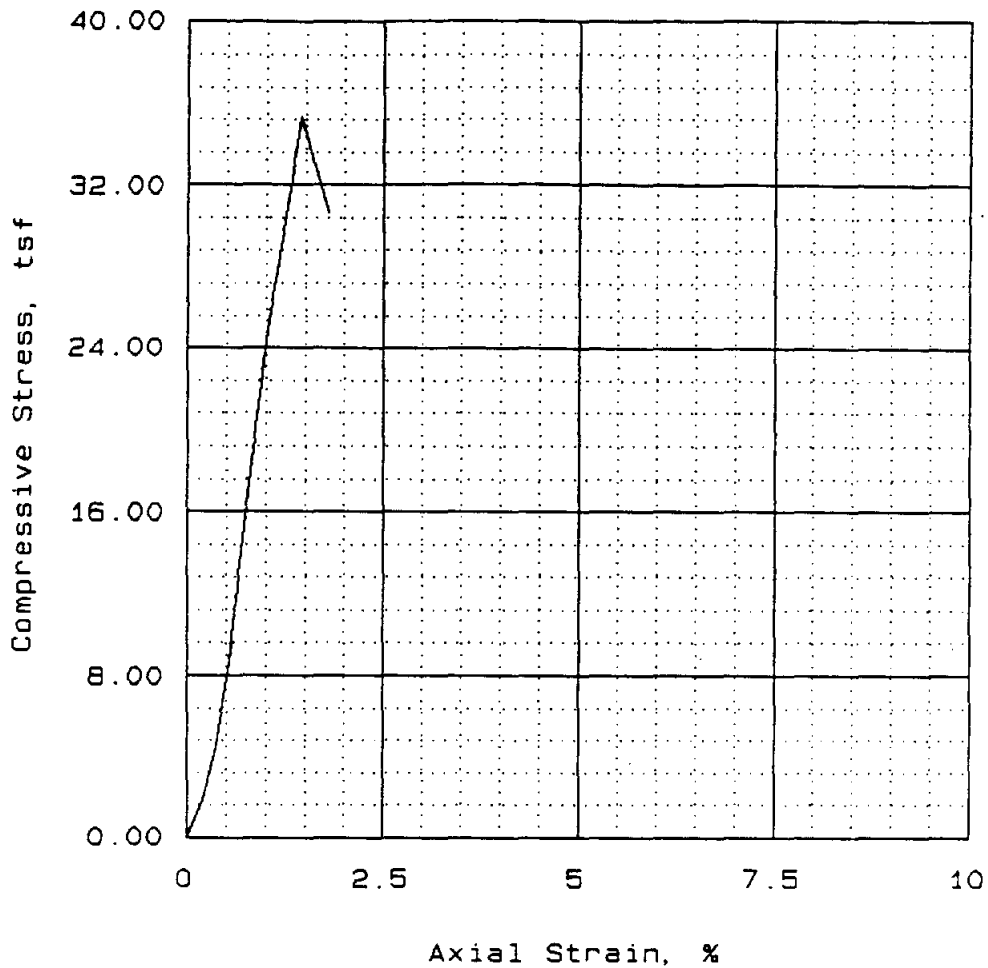

Sample number:	1			
Unconfined strength, tsf	35.36			
Undrained shear strength, tsf	17.68			
Rate of strain, %/min	0.110			
Water content, %	8.7			
Void ratio	0.3462			
Saturation, %	68.2			
Dry density, pcf	125.7			
Specimen diameter, in	3.81			
Specimen height, in	6.99			

Description: SANDSTONE

LL =      PL =      PI =      GS = 2.71      Type: UNDISTURBED

Project No.: 15296

Date: APRIL 1991

Remarks:

SPECIFIC GRAVITY

ESTIMATED

Client: US ARMY CORPS OF ENGINEERS

TULSA DISTRICT

Project: PLUM CREEK

FOUNDATION MATERIALS

Location: BORING: PC-16, BOX-1

7.0-7.6, SWD LAB NO. 91/108

UNCONFINED COMPRESSION TEST

CORPS OF ENGINEERS - SOUTHWESTERN

Fig No.

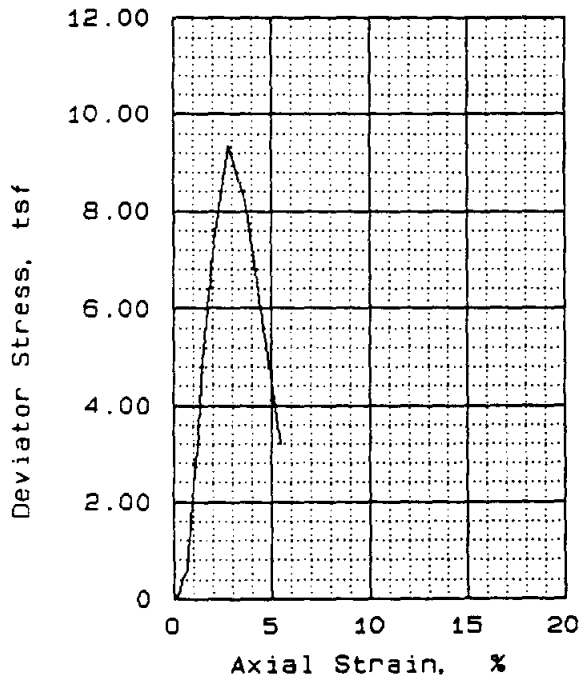
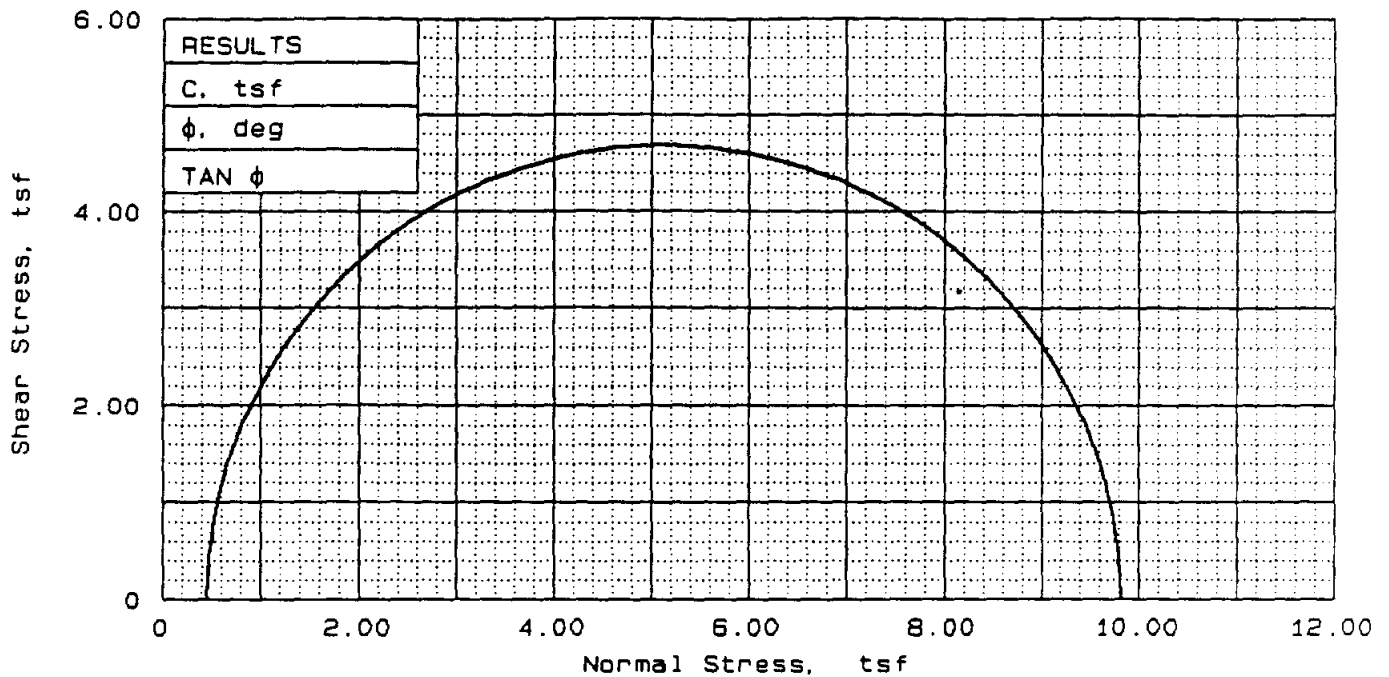

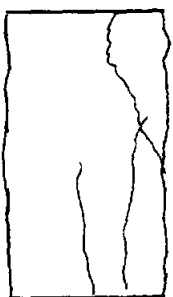
SAMPLE NO.		1
INITIAL	WATER CONTENT, %	9.7
	DRY DENSITY, pcf	131.0
	SATURATION, %	92.8
	VOID RATIO	0.282
	DIAMETER, in	5.68
HEIGHT, in		10.57
AT TEST	WATER CONTENT, %	9.7
	DRY DENSITY, pcf	131.0
	SATURATION, %	92.8
	VOID RATIO	0.282
	DIAMETER, in	5.68
HEIGHT, in		10.57
BACK PRESSURE, tsf	0.00	
CELL PRESSURE, tsf	0.45	
FAILURE STRESS, tsf	9.37	
PORE PRESSURE, tsf		
STRAIN RATE, %/min.	0.170	
ULTIMATE STRESS, tsf		
PORE PRESSURE, tsf		
$\sigma_1$ FAILURE, tsf	9.81	
$\sigma_3$ FAILURE, tsf	0.45	

TYPE OF TEST:  
Unconsolidated undrained

SAMPLE TYPE: UNDISTURBED

DESCRIPTION: SHALE

LL = 39      PL = 16      PI = 23.0

SPECIFIC GRAVITY = 2.69

REMARKS: SPECIFIC GRAVITY ESTIMATED

CLIENT: US ARMY CORPS OF ENGINEERS  
TULSA DISTRICT

PROJECT: PLUM CREEK  
FOUNDATION MATERIALS

SAMPLE LOCATION: PC-10, CTN-1  
6.4-7.3, SWD-LAB NO. 91/71

PROJ. NO.: 15296      DATE: MARCH 1991

FIG. NO.

TRIAxIAL COMPRESSION TEST

**CORPS OF ENGINEERS - SOUTHWESTERN**

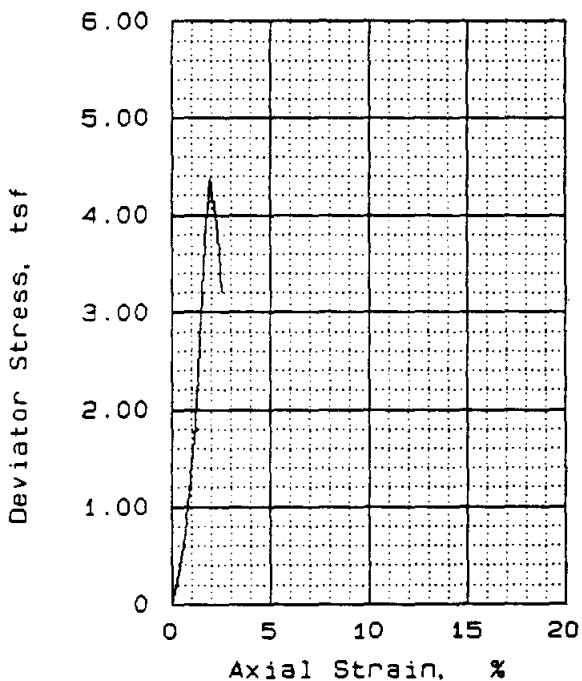
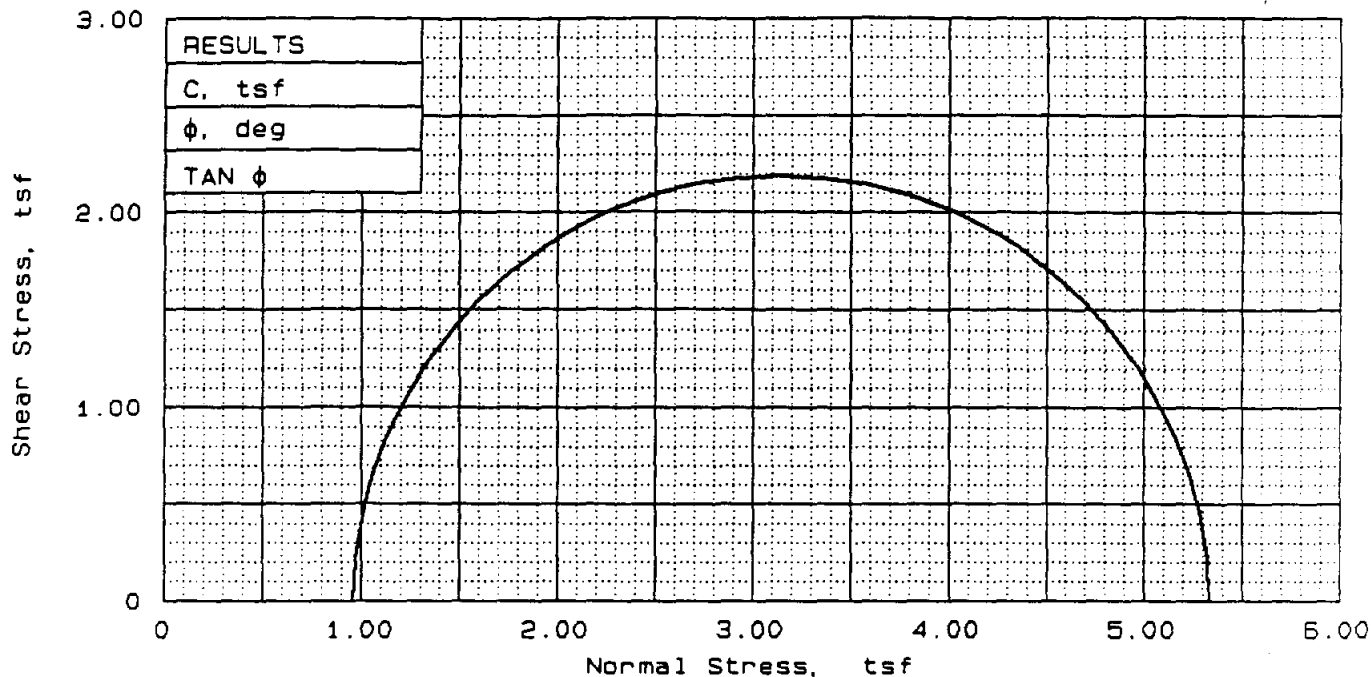

SAMPLE NO.		1
INITIAL	WATER CONTENT, %	13.2
	DRY DENSITY, pcf	118.3
	SATURATION, %	84.7
	VOID RATIO	0.419
	DIAMETER, in	3.71
	HEIGHT, in	8.07
AT TEST	WATER CONTENT, %	13.2
	DRY DENSITY, pcf	118.3
	SATURATION, %	84.7
	VOID RATIO	0.419
	DIAMETER, in	3.71
	HEIGHT, in	8.07
BACK PRESSURE, tsf	0.00	
CELL PRESSURE, tsf	0.96	
FAILURE STRESS, tsf	4.37	
PORE PRESSURE, tsf		
STRAIN RATE, %/min.		
ULTIMATE STRESS, tsf		
PORE PRESSURE, tsf		
$\sigma_1$ FAILURE, tsf	5.33	
$\sigma_3$ FAILURE, tsf	0.96	



TYPE OF TEST:  
Unconsolidated undrained  
SAMPLE TYPE: UNDISTURBED  
DESCRIPTION: SHALE

LL= 55      PL= 26      PI= 29.0  
SPECIFIC GRAVITY= 2.69  
REMARKS: SPECIFIC GRAVITY  
ESTIMATED

CLIENT: US ARMY CORPS OF ENGINEER  
TULSA DISTRICT  
PROJECT: PLUM CREEK  
FOUNDATION MATERIALS  
SAMPLE LOCATION: BORING: PC-11, BOX-2  
14.4-15.1, SWD LAB NO. 91/78

PROJ. NO.: 15296      DATE: APRIL 1991

TRIAxIAL COMPRESSION TEST

CORPS OF ENGINEERS - SOUTHWESTERN

FIG. NO.

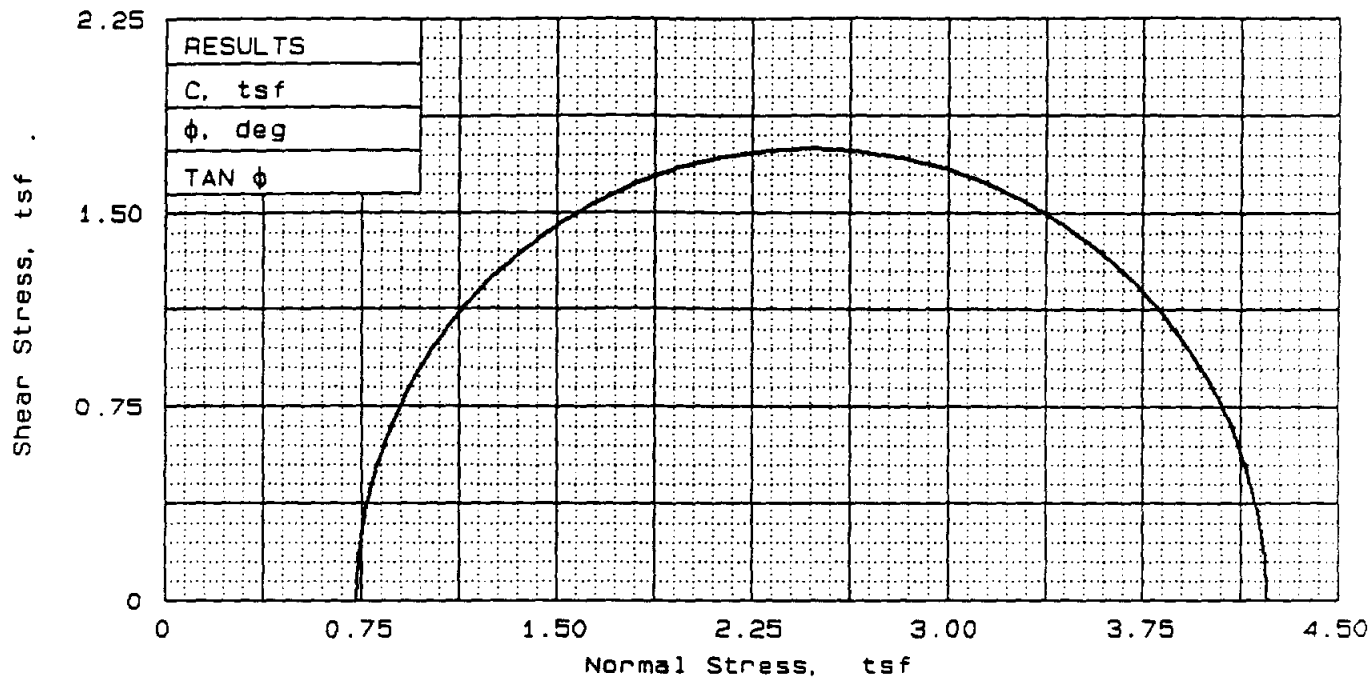

**RESULTS**  
 C, tsf  
 $\phi$ , deg  
 TAN  $\phi$

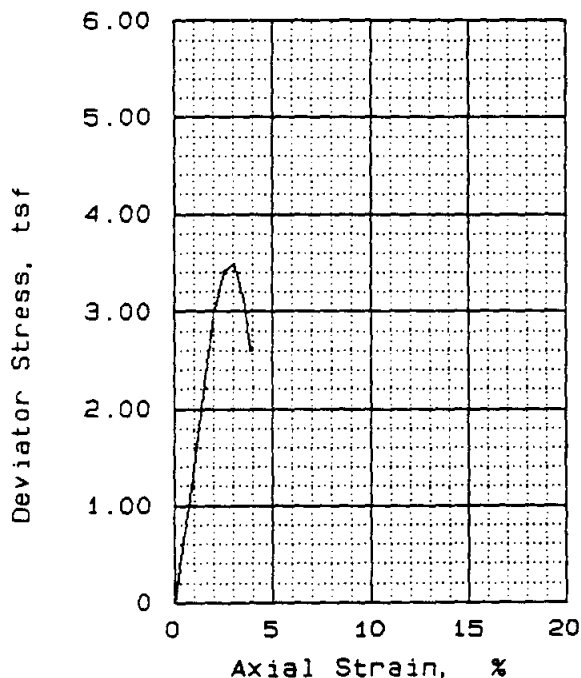

SAMPLE NO.		1
INITIAL	WATER CONTENT, %	13.2
	DRY DENSITY, pcf	124.1
	SATURATION, %	100.4
	VOID RATIO	0.353
	DIAMETER, in	3.80
AT TEST	HEIGHT, in	8.02
	WATER CONTENT, %	13.2
	DRY DENSITY, pcf	124.1
	SATURATION, %	100.4
	VOID RATIO	0.353
	DIAMETER, in	3.80
	HEIGHT, in	8.02
BACK PRESSURE, tsf		0.00
CELL PRESSURE, tsf		0.73
FAILURE STRESS, tsf		3.49
PORE PRESSURE, tsf		
STRAIN RATE, %/min.		
ULTIMATE STRESS, tsf		
PORE PRESSURE, tsf		
$\sigma_1$ FAILURE, tsf		4.22
$\sigma_3$ FAILURE, tsf		0.73



TYPE OF TEST:  
 Unconsolidated undrained  
 SAMPLE TYPE: UNDISTURBED  
 DESCRIPTION: SHALE  
 LL= 44      PL= 16      PI= 28.0  
 SPECIFIC GRAVITY= 2.69  
 REMARKS: SPECIFIC GRAVITY  
 ESTIMATED

CLIENT: US ARMY CORPS OF ENGINEERS  
 TULSA DISTRICT  
 PROJECT: PLUM CREEK  
 FOUNDATION MATERIALS  
 SAMPLE LOCATION: BORING: PC-12, BOX-2  
 10.9-11.5, SWD LAB NO. 91/83  
 PROJ. NO.: 15296      DATE: APRIL 1991

TRIAxIAL COMPRESSION TEST

**CORPS OF ENGINEERS - SOUTHWESTERN**

FIG. NO.

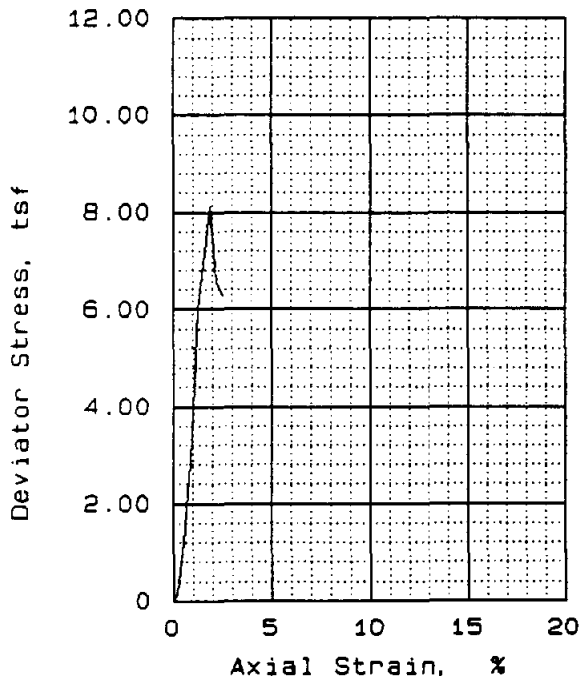
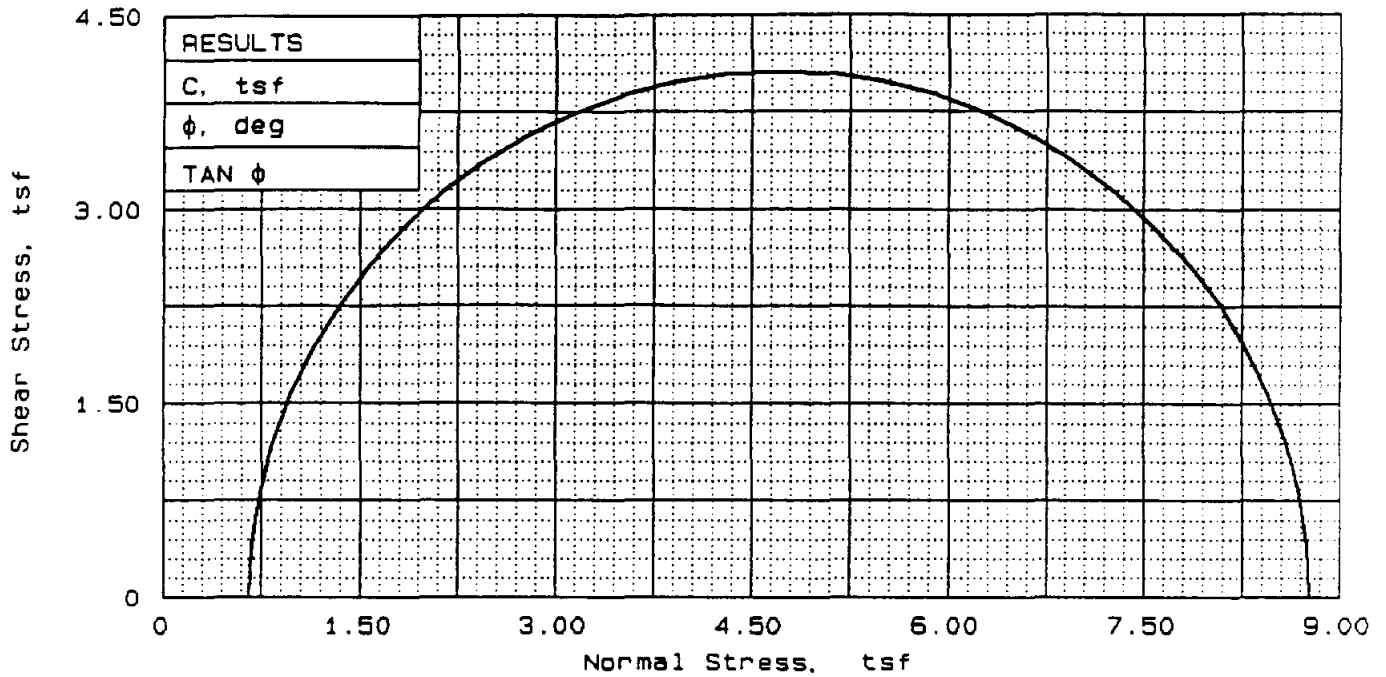

SAMPLE NO.		1
INITIAL	WATER CONTENT, %	9.8
	DRY DENSITY, pcf	130.1
	SATURATION, %	90.4
	VOID RATIO	0.291
	DIAMETER, in	5.76
AT TEST	HEIGHT, in	10.07
	WATER CONTENT, %	9.8
	DRY DENSITY, pcf	130.1
	SATURATION, %	90.4
	VOID RATIO	0.291
DIAMETER, in	5.76	
HEIGHT, in	10.07	
BACK PRESSURE, tsf	0.00	
CELL PRESSURE, tsf	0.66	
FAILURE STRESS, tsf	8.11	
PORE PRESSURE, tsf		
STRAIN RATE, %/min.		
ULTIMATE STRESS, tsf		
PORE PRESSURE, tsf		
$\sigma_1$ FAILURE, tsf	8.77	
$\sigma_3$ FAILURE, tsf	0.66	

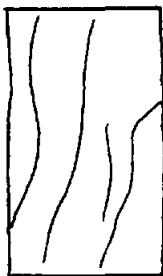

TYPE OF TEST:  
Unconsolidated undrained  
SAMPLE TYPE: UNDISTURBED  
DESCRIPTION: SHALE  
  
LL=            PL=            PI=  
SPECIFIC GRAVITY= 2.69  
REMARKS: SPECIFIC GRAVITY  
ESTIMATED

CLIENT: US ARMY CORPS OF ENGINEERS  
TULSA DISTRICT  
PROJECT: PLUM CREEK  
FOUNDATION MATERIALS  
SAMPLE LOCATION: BORING: PC-13, CTN-1  
9.7-10.6, SWD LAB NO. 91/89  
PROJ. NO.: 15296                      DATE: APRIL 1991

FIG. NO.

TRIAxIAL COMPRESSION TEST  
**CORPS OF ENGINEERS - SOUTHWESTERN**



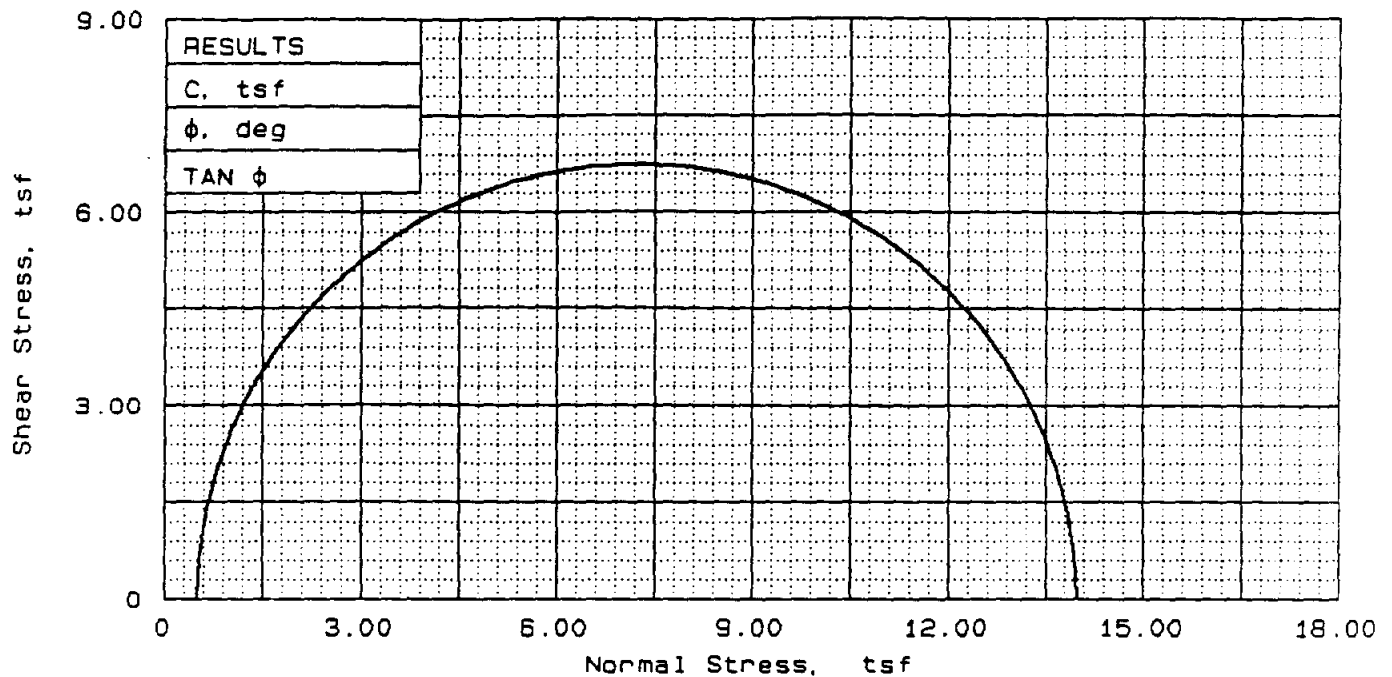

RESULTS
C, tsf
$\phi$ , deg
TAN $\phi$

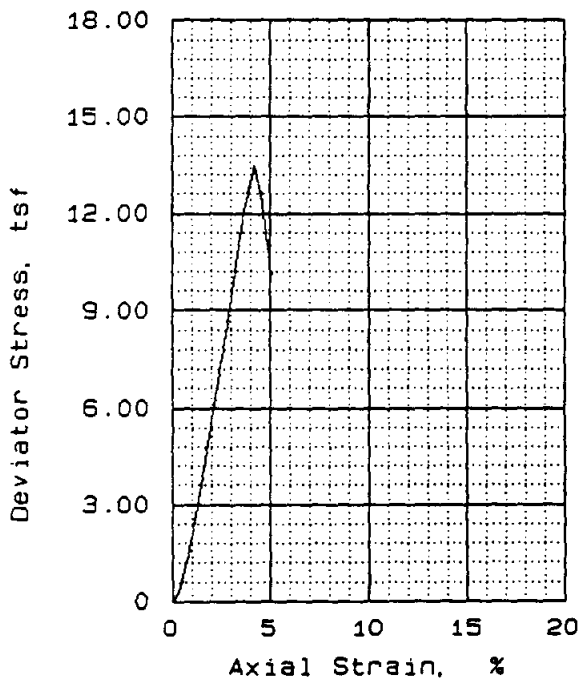

SAMPLE NO.		1
INITIAL	WATER CONTENT, %	8.8
	DRY DENSITY, pcf	135.5
	SATURATION, %	100.1
	VOID RATIO	0.234
	DIAMETER, in	3.74
	HEIGHT, in	8.01
AT TEST	WATER CONTENT, %	8.8
	DRY DENSITY, pcf	135.5
	SATURATION, %	100.1
	VOID RATIO	0.234
	DIAMETER, in	3.74
	HEIGHT, in	8.01
BACK PRESSURE, tsf	0.00	
CELL PRESSURE, tsf	0.50	
FAILURE STRESS, tsf	13.49	
PORE PRESSURE, tsf		
STRAIN RATE, %/min.	0.250	
ULTIMATE STRESS, tsf		
PORE PRESSURE, tsf		
$\sigma_1$ FAILURE, tsf	13.99	
$\sigma_3$ FAILURE, tsf	0.5	

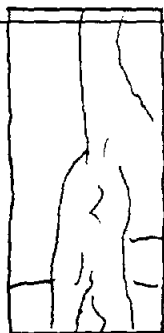

TYPE OF TEST:  
 Unconsolidated undrained  
 SAMPLE TYPE: UNDISTURBED  
 DESCRIPTION: SANDSTONE WITH  
 ALTERNATING LAYERS OF SHALE  
 LL=            PL=            PI=  
 SPECIFIC GRAVITY= 2.68  
 REMARKS: SPECIFIC GRAVITY  
 ESTIMATED

CLIENT: US ARMY CORPS OF ENGINEERS  
 TULSA DISTRICT  
 PROJECT: PLUM CREEK  
 FOUNDATION MATERIALS  
 SAMPLE LOCATION: BORING: PC-14, BOX-1  
 7.3-8.0, SWD LAB NO. 91/92  
 PROJ. NO.: 15296                      DATE: APRIL 1991

FIG. NO.

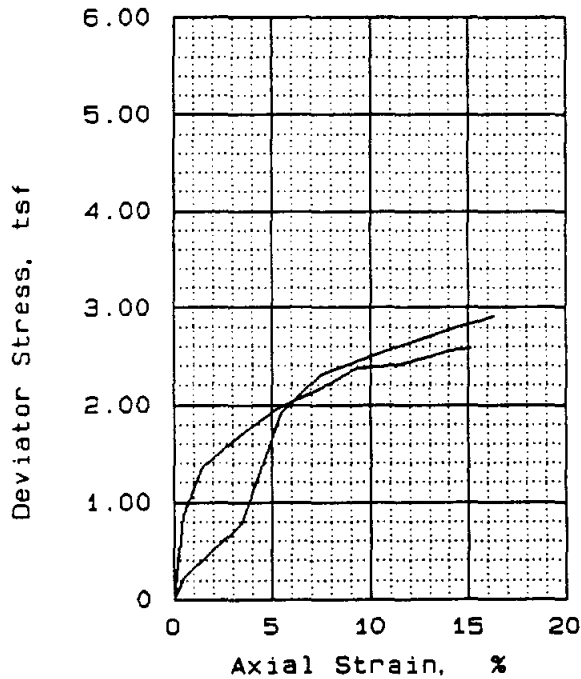
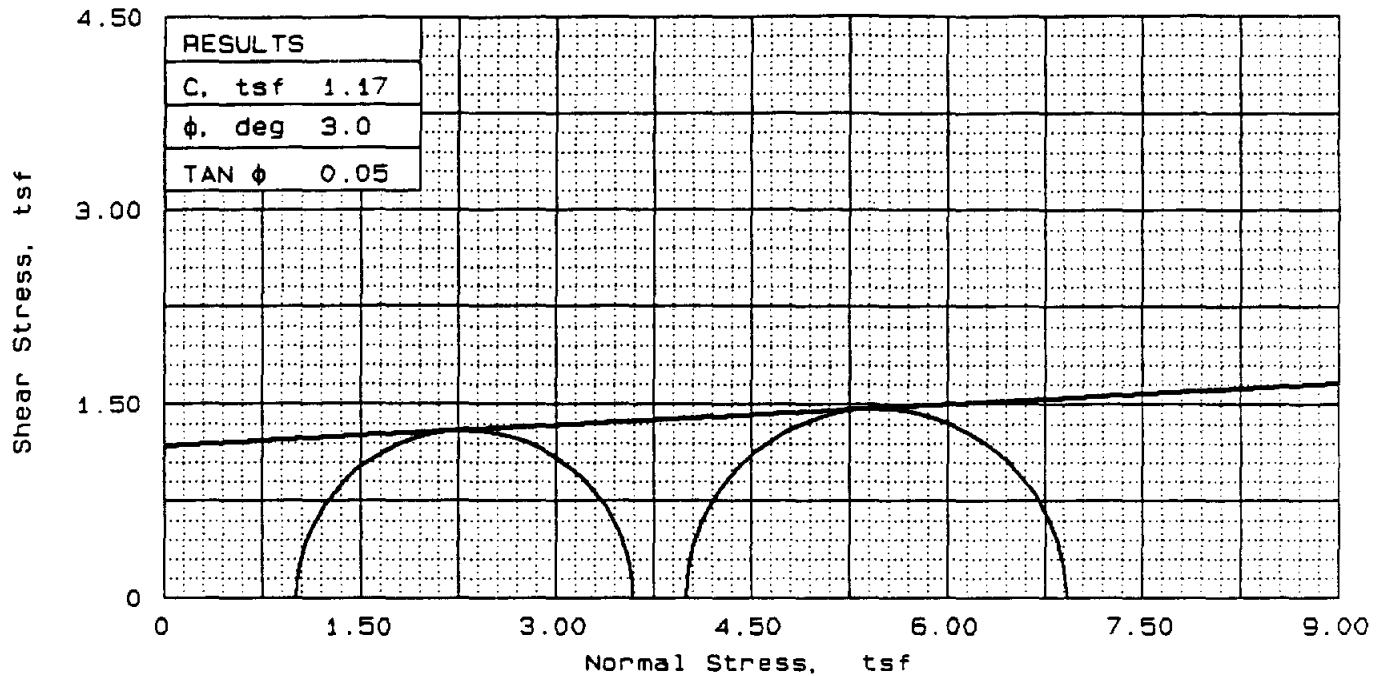

SAMPLE NO.		1	2
INITIAL	WATER CONTENT, %	17.8	17.7
	DRY DENSITY, pcf	107.4	109.0
	SATURATION, %	85.6	89.2
	VOID RATIO	0.558	0.535
	DIAMETER, in	1.38	1.37
HEIGHT, in	3.07	3.02	
AT TEST	WATER CONTENT, %	17.7	17.8
	DRY DENSITY, pcf	107.4	109.0
	SATURATION, %	85.2	89.2
	VOID RATIO	0.558	0.535
	DIAMETER, in	1.38	1.37
HEIGHT, in	3.07	3.02	
BACK PRESSURE, tsf	0.00	0.00	
CELL PRESSURE, tsf	1.01	4.00	
FAILURE STRESS, tsf	2.58	2.92	
PORE PRESSURE, tsf			
STRAIN RATE, %/min.	0.880	0.880	
ULTIMATE STRESS, tsf			
PORE PRESSURE, tsf			
$\sigma_1$ FAILURE, tsf	3.59	6.92	
$\sigma_3$ FAILURE, tsf	1.01	4	

TYPE OF TEST:  
 Unconsolidated undrained  
 SAMPLE TYPE: UNDISTURBED  
 DESCRIPTION: LEAN CLAY (CL)  
 LL = 33      PL = 14      PI = 19.0  
 SPECIFIC GRAVITY = 2.68  
 REMARKS: SPECIFIC GRAVITY  
 ESTIMATED

CLIENT: US ARMY CORPS OF ENGINEERS  
 TULSA DISTRICT  
 PROJECT: PLUM CREEK  
 FOUNDATION MATERIALS  
 SAMPLE LOCATION: PC-5, DB-1  
 2.1-2.9, SWD-LAB NO. 91/31  
 PROJ NO.: 15296      DATE: MARCH 1991

TRIAXIAL COMPRESSION TEST  
**CORPS OF ENGINEERS - SOUTHWESTERN**

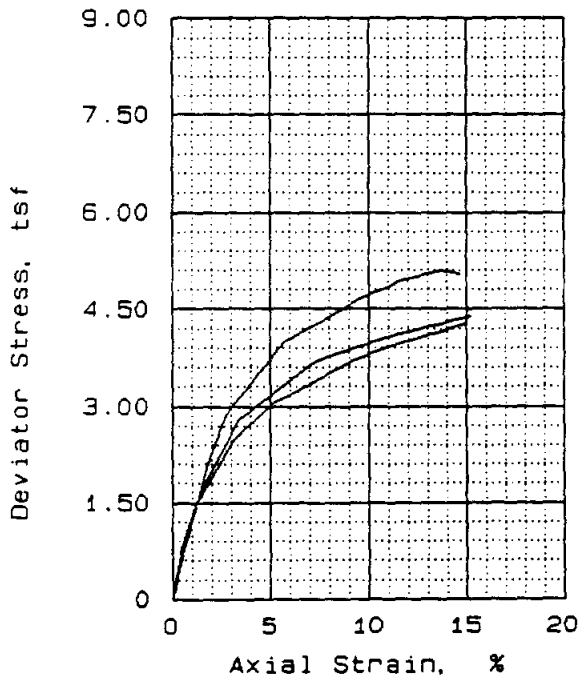
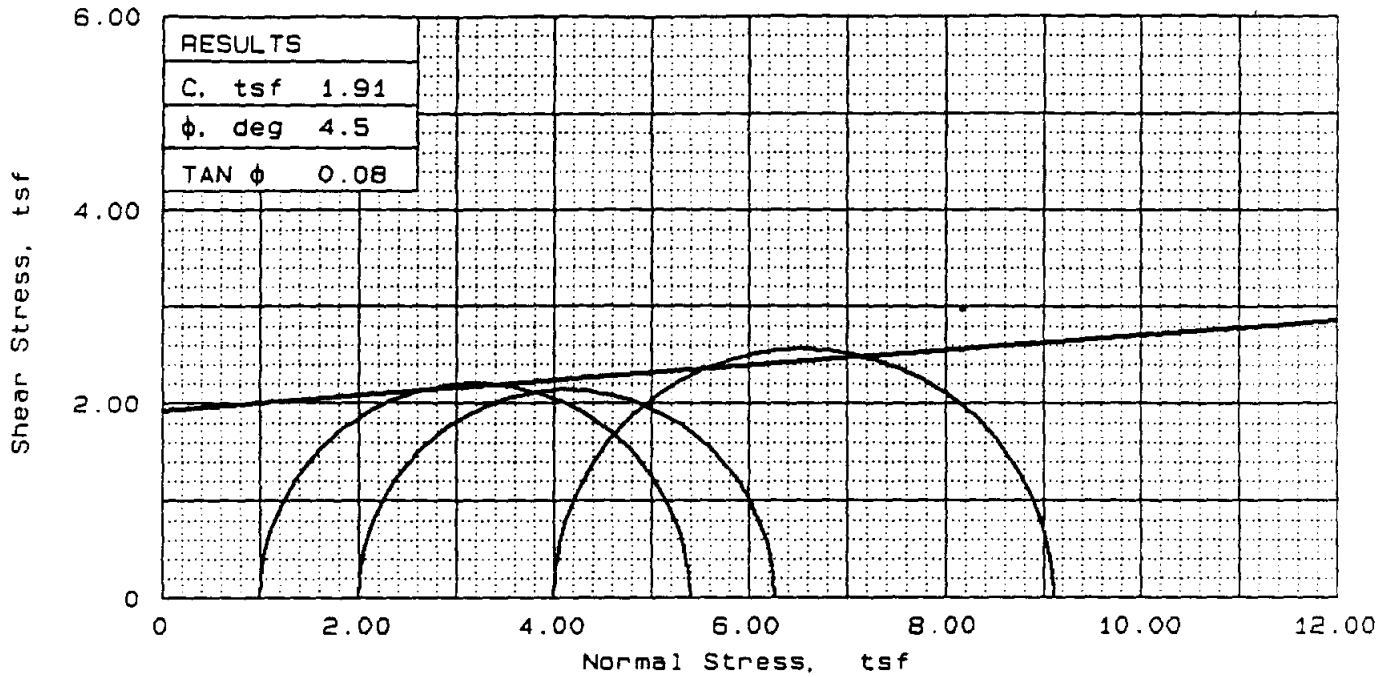

SAMPLE NO.		1	2	3
INITIAL	WATER CONTENT, %	16.5	15.9	16.2
	DRY DENSITY, pcf	107.8	108.9	107.5
	SATURATION, %	79.8	79.0	77.3
	VOID RATIO	0.557	0.542	0.562
	DIAMETER, in	1.38	1.40	1.37
	HEIGHT, in	3.04	3.04	3.03
AT TEST	WATER CONTENT, %	15.5	16.2	15.9
	DRY DENSITY, pcf	107.8	108.9	107.5
	SATURATION, %	74.9	80.4	76.0
	VOID RATIO	0.557	0.542	0.562
	DIAMETER, in	1.38	1.40	1.37
	HEIGHT, in	3.04	3.04	3.03
BACK PRESSURE, tsf		0.00	0.00	0.00
CELL PRESSURE, tsf		1.00	2.00	4.00
FAILURE STRESS, tsf		4.40	4.26	5.11
PORE PRESSURE, tsf				
STRAIN RATE, %/min.		0.880	0.880	0.880
ULTIMATE STRESS, tsf				
PORE PRESSURE, tsf				
$\sigma_1$ FAILURE, tsf		5.40	6.27	9.11
$\sigma_3$ FAILURE, tsf		1	2	4

TYPE OF TEST:  
Unconsolidated undrained  
SAMPLE TYPE: UNDISTURBED  
DESCRIPTION: LEAN CLAY (CL)

LL= 27      PL= 13      PI= 14  
SPECIFIC GRAVITY= 2.69  
REMARKS: SPECIFIC GRAVITY  
ESTIMATED

FIG. NO.

CLIENT: US ARMY CORPS OF ENGINEERS  
TULSA DISTRICT  
PROJECT: PLUM CREEK - FOUNDATION

SAMPLE LOCATION: BORING: PC-5, DB-3  
6.3-7.1, SWD LAB NO. 91/33

PROJ NO.: 15296      DATE: FEB 1991

TRIAxIAL COMPRESSION TEST

CORPS OF ENGINEERS - SOUTHWESTERN

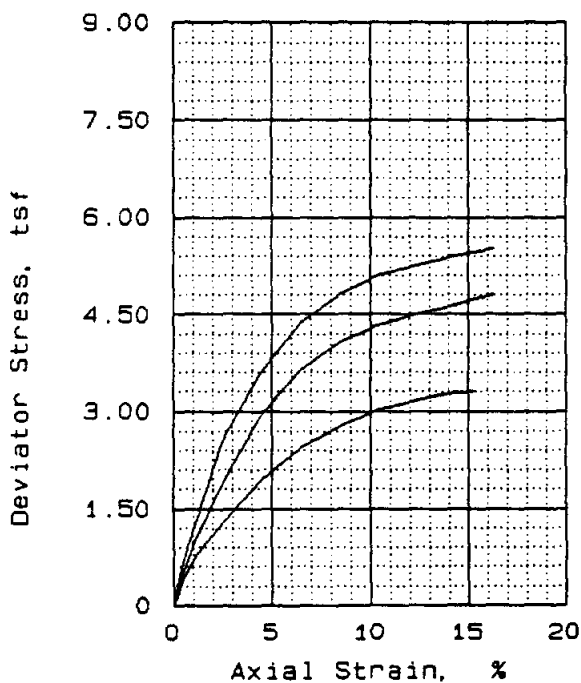
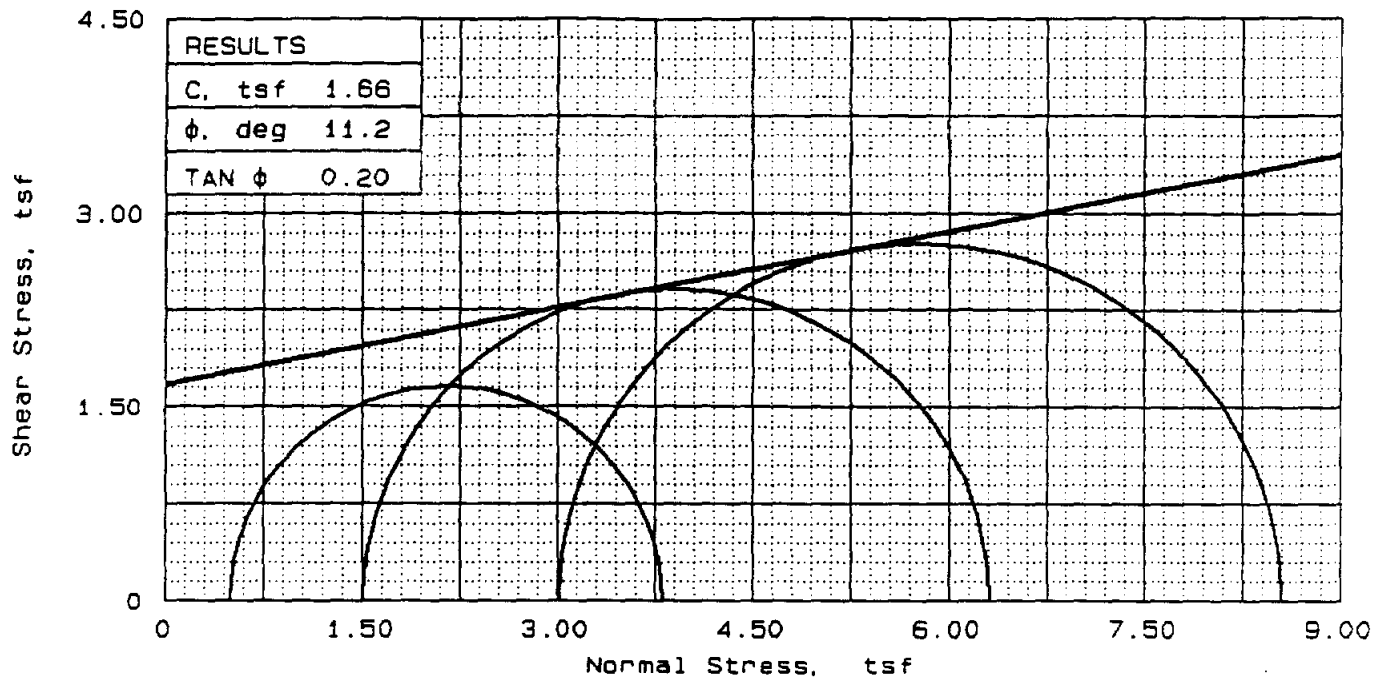

SAMPLE NO.		1	2	3
INITIAL	WATER CONTENT, %	12.5	12.9	13.8
	DRY DENSITY, pcf	124.0	120.6	119.7
	SATURATION, %	96.2	89.3	93.1
	VOID RATIO	0.349	0.387	0.397
	DIAMETER, in	1.36	1.36	1.39
	HEIGHT, in	3.02	3.02	3.04
AT TEST	WATER CONTENT, %	13.1	11.9	12.8
	DRY DENSITY, pcf	124.0	120.6	119.7
	SATURATION, %	100.3	82.3	85.4
	VOID RATIO	0.349	0.387	0.397
	DIAMETER, in	1.36	1.36	1.39
	HEIGHT, in	3.02	3.02	3.04
BACK PRESSURE, tsf		0.00	0.00	0.00
CELL PRESSURE, tsf		0.50	1.51	3.02
FAILURE STRESS, tsf		3.31	4.80	5.53
PORE PRESSURE, tsf				
STRAIN RATE, %/min.		0.880	0.880	0.880
ULTIMATE STRESS, tsf				
PORE PRESSURE, tsf				
$\sigma_1$ FAILURE, tsf		3.81	6.32	8.55
$\sigma_3$ FAILURE, tsf		0.5	1.51	3.02

TYPE OF TEST:  
 Unconsolidated undrained  
 SAMPLE TYPE: UNDISTURBED  
 DESCRIPTION: LEAN CLAY (CL)

LL= 32      PL= 13      PI= 19.0  
 SPECIFIC GRAVITY= 2.68  
 REMARKS: SPECIFIC GRAVITY  
 ESTIMATED

CLIENT: US ARMY CORPS OF ENGINEERS  
 TULSA DISTRICT  
 PROJECT: PLUM CREEK  
 FOUNDATION MATERIALS

SAMPLE LOCATION: PC-5, DB-5  
 10.6-11.4, SWD-LAB NO. 91/35

PROJ. NO.: 15296      DATE: MARCH 1991

TRIAxIAL COMPRESSION TEST

CORPS OF ENGINEERS - SOUTHWESTERN

FIG. NO.

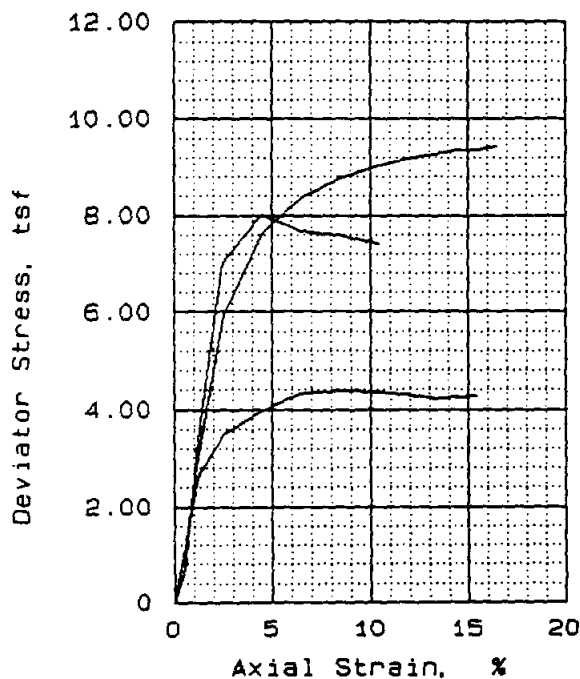
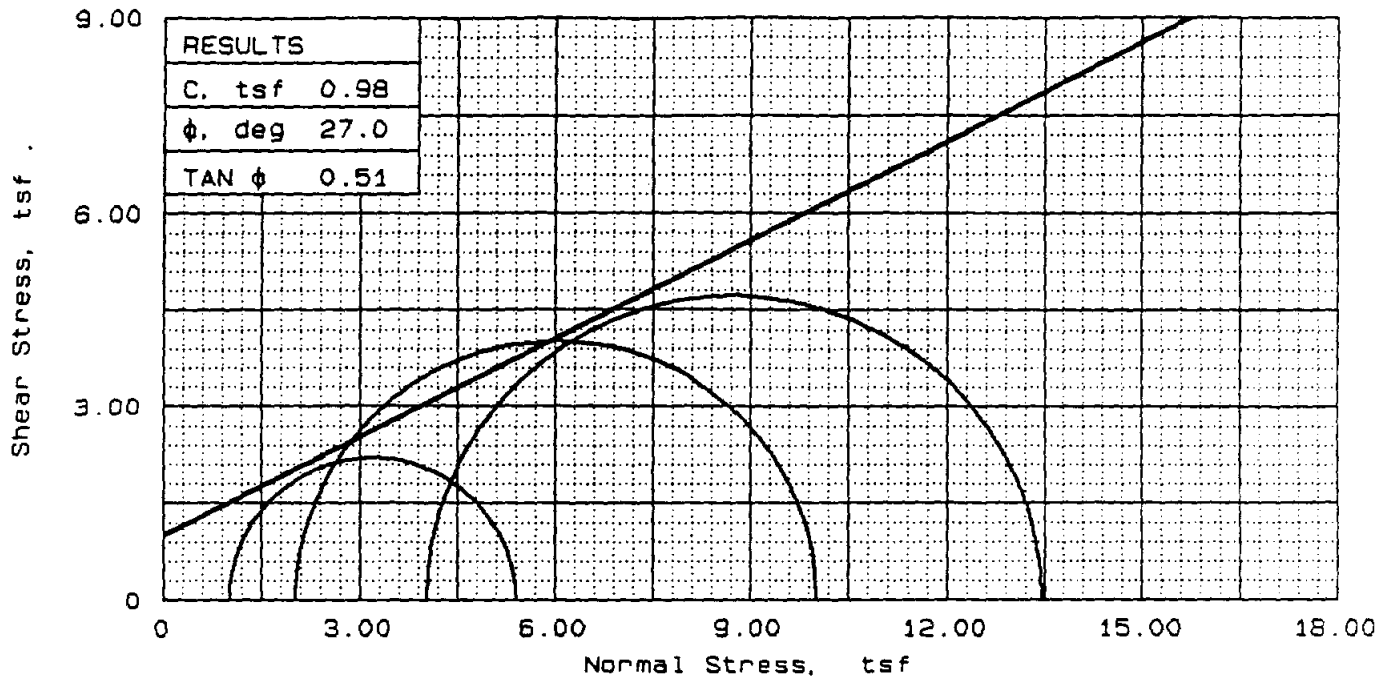

SAMPLE NO.		1	2	3
INITIAL	WATER CONTENT, %	13.6	10.9	12.2
	DRY DENSITY, pcf	110.9	111.8	112.8
	SATURATION, %	71.7	58.6	67.6
	VOID RATIO	0.509	0.496	0.483
	DIAMETER, in	1.34	1.37	1.39
	HEIGHT, in	3.03	3.04	3.01
AT TEST	WATER CONTENT, %	12.0	8.8	11.2
	DRY DENSITY, pcf	110.9	111.8	112.8
	SATURATION, %	63.3	47.5	62.3
	VOID RATIO	0.509	0.496	0.483
	DIAMETER, in	1.34	1.37	1.39
	HEIGHT, in	3.03	3.04	3.01
BACK PRESSURE, tsf		0.00	0.00	0.00
CELL PRESSURE, tsf		1.01	2.02	4.03
FAILURE STRESS, tsf		4.39	8.01	9.43
PORE PRESSURE, tsf				
STRAIN RATE, %/min.		0.880	0.880	0.880
ULTIMATE STRESS, tsf				
PORE PRESSURE, tsf				
$\sigma_1$ FAILURE, tsf		5.40	10.03	13.47
$\sigma_3$ FAILURE, tsf		1.01	2.02	4.03

TYPE OF TEST:  
Unconsolidated undrained

SAMPLE TYPE: UNDISTURBED

DESCRIPTION: SANDY LEAN CLAY  
(CL)

LL= 26      PL= 14      PI= 12.0

SPECIFIC GRAVITY= 2.68

REMARKS: SPECIFIC GRAVITY  
ESTIMATED

CLIENT: US ARMY CORPS OF ENGINEERS  
TULSA DISTRICT

PROJECT: PLUM CREEK  
FOUNDATION MATERIALS

SAMPLE LOCATION: PC-8, DB-4  
8.0-10.0, SWD-LAB NO. 91/59

PROJ. NO.: 15296      DATE: MARCH 1991

TRIAxIAL COMPRESSION TEST

CORPS OF ENGINEERS - SOUTHWESTERN

FIG. NO.

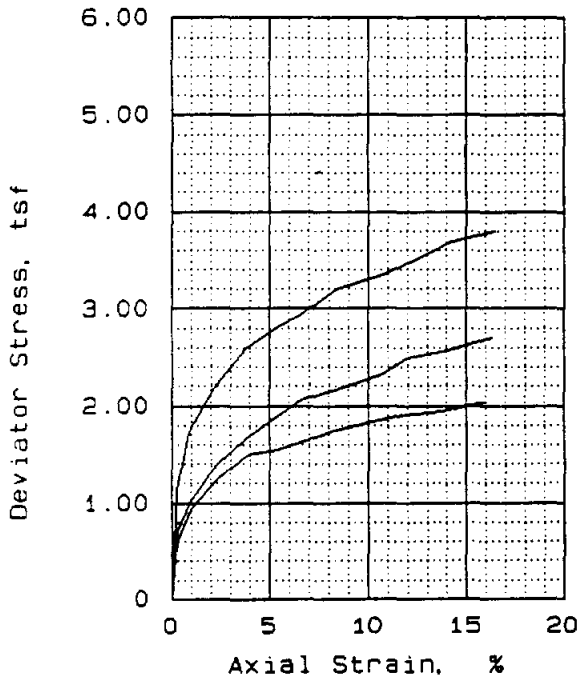
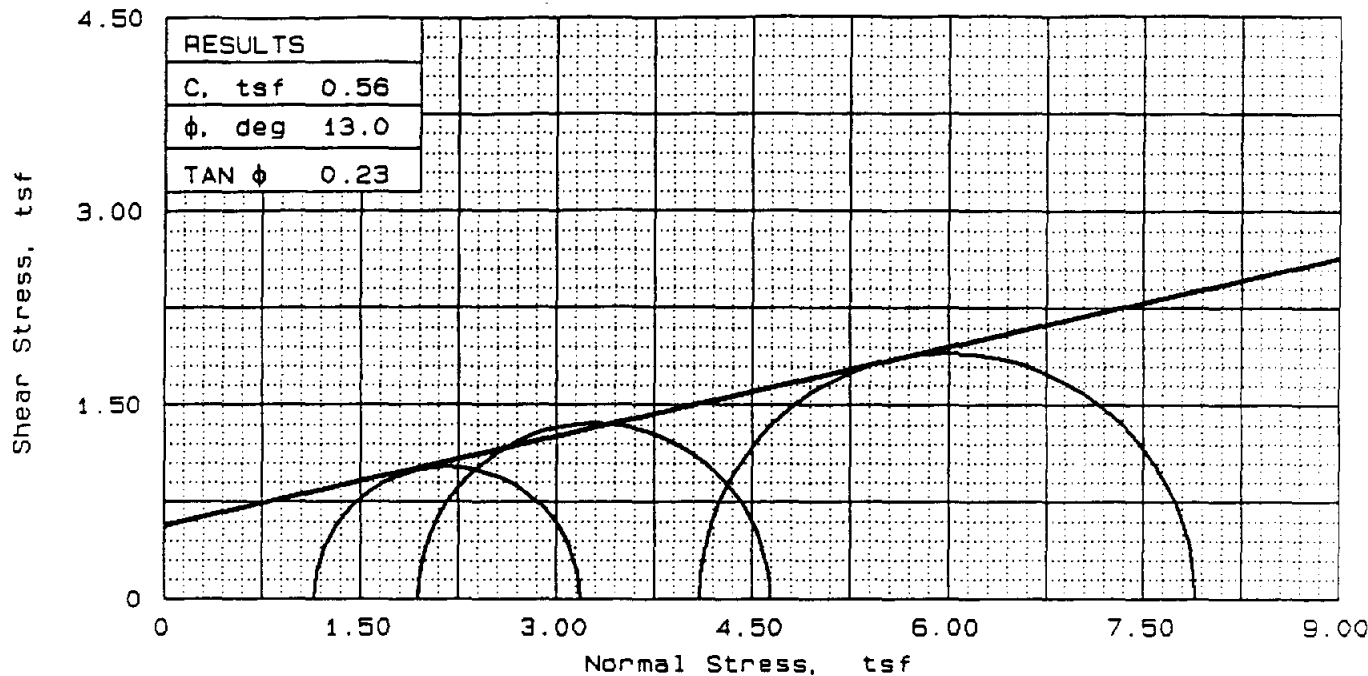

SAMPLE NO.		1	2	3
INITIAL	WATER CONTENT, %	18.9	18.7	17.5
	DRY DENSITY, pcf	109.3	108.8	110.4
	SATURATION, %	94.9	92.3	90.3
	VOID RATIO	0.537	0.544	0.522
	DIAMETER, in	1.34	1.36	1.30
AT TEST	HEIGHT, in	3.07	3.00	3.02
	WATER CONTENT, %	20.0	19.6	17.5
	DRY DENSITY, pcf	109.1	109.9	114.1
	SATURATION, %	100.0	100.0	100.0
	VOID RATIO	0.539	0.529	0.471
ULTIMATE STRESS, tsf	DIAMETER, in	1.34	1.36	1.30
	HEIGHT, in	3.05	2.97	2.95
	BACK PRESSURE, tsf	7.63	7.06	7.56
	CELL PRESSURE, tsf	8.78	9.00	11.66
	FAILURE STRESS, tsf	2.04	2.70	3.80
	PORE PRESSURE, tsf			
	STRAIN RATE, %/min.	0.050	0.050	0.050
	PORE PRESSURE, tsf			
	$\sigma_1$ FAILURE, tsf	3.19	4.65	7.90
	$\sigma_3$ FAILURE, tsf	1.15	1.94	4.1

TYPE OF TEST:  
Consolidated undrained

SAMPLE TYPE: UNDISTURBED

DESCRIPTION: LEAN CLAY

LL= 33      PL= 14      PI= 19.0

SPECIFIC GRAVITY= 2.69

REMARKS: SPECIFIC GRAVITY ESTIMATED

CLIENT: US ARMY CORPS OF ENGINEERS  
TULSA DISTRICT

PROJECT: PLUM CREEK

SAMPLE LOCATION: BORING: PC-5, DB-1  
2.0-2.9, SWD LAB NO. 91/31

PROJ. NO.: 15296      DATE: MARCH 1991

TRIAxIAL COMPRESSION TEST

**CORPS OF ENGINEERS - SOUTHWESTERN**

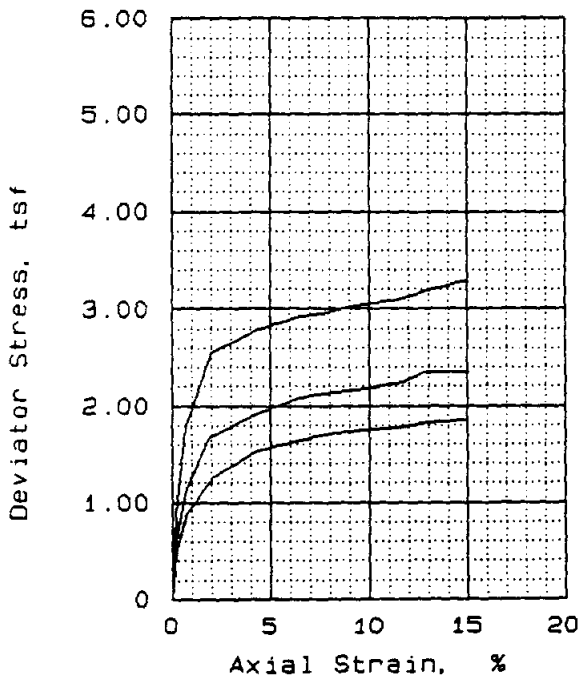
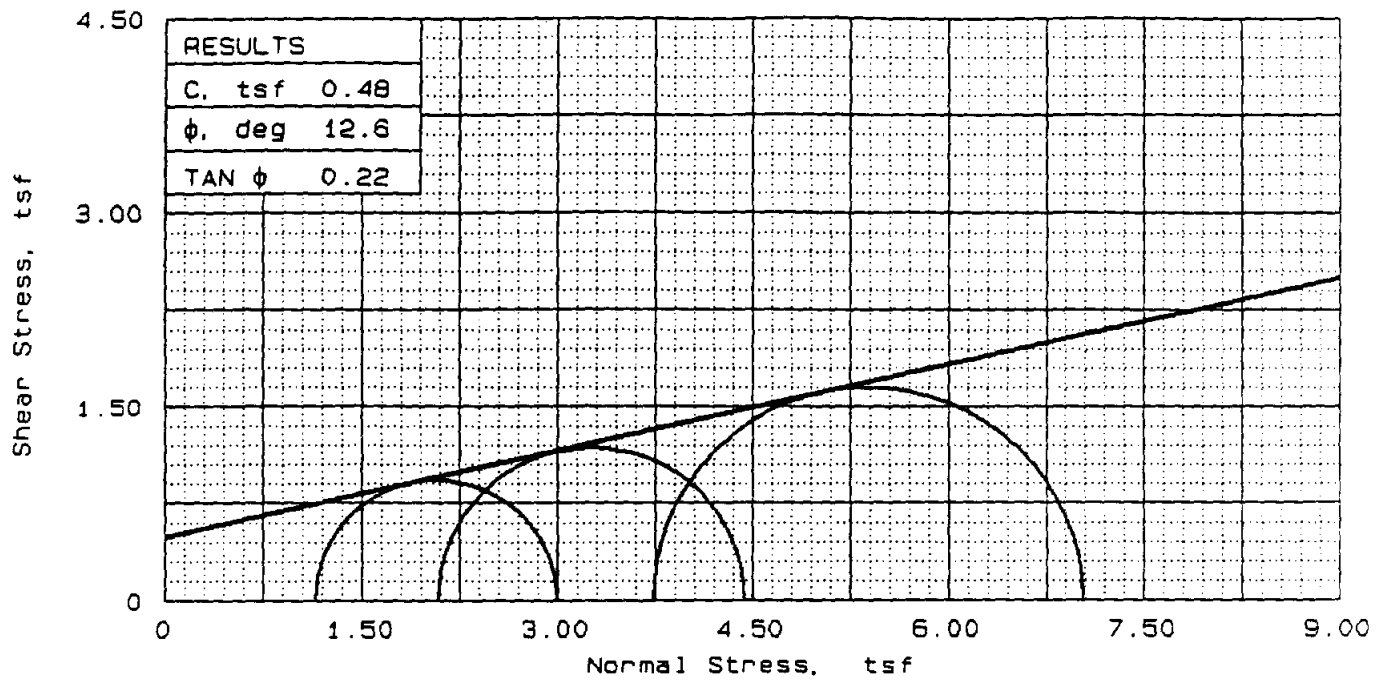

SAMPLE NO.		1	2	3
INITIAL	WATER CONTENT, %	16.5	16.2	15.5
	DRY DENSITY, pcf	108.4	109.1	110.1
	SATURATION, %	80.9	80.9	84.2
	VOID RATIO	0.550	0.539	0.526
	DIAMETER, in	1.39	1.40	1.38
	HEIGHT, in	3.02	3.04	3.02
AT TEST	WATER CONTENT, %	20.1	19.2	18.8
	DRY DENSITY, pcf	109.0	110.7	111.5
	SATURATION, %	100.0	100.0	100.0
	VOID RATIO	0.541	0.517	0.507
	DIAMETER, in	1.39	1.40	1.38
	HEIGHT, in	2.99	2.97	2.98
BACK PRESSURE, tsf		9.07	7.49	7.99
CELL PRESSURE, tsf		10.22	11.23	10.08
FAILURE STRESS, tsf		1.85	3.29	2.35
PORE PRESSURE, tsf				
STRAIN RATE, %/min.		0.050	0.050	0.050
ULTIMATE STRESS, tsf				
PORE PRESSURE, tsf				
$\sigma_1$ FAILURE, tsf		3.00	7.04	4.44
$\sigma_3$ FAILURE, tsf		1.15	3.74	2.09

TYPE OF TEST:  
 Consolidated undrained  
 SAMPLE TYPE: UNDISTURBED  
 DESCRIPTION: LEAN CLAY WITH SAND (CL)  
 LL= 27      PL= 13      PI= 14.0  
 SPECIFIC GRAVITY= 2.69  
 REMARKS: SPECIFIC GRAVITY ESTIMATED

CLIENT: US ARMY CORPS OF ENGINEERS  
 TULSA DISTRICT  
 PROJECT: PLUM CREEK  
 SAMPLE LOCATION: BORING: PC-5, DB-3  
 6.3-7.1, SWD LAB NO. 91/33  
 PROJ. NO.: 15296      DATE: MARCH 1991

TRIAxIAL COMPRESSION TEST

CORPS OF ENGINEERS - SOUTHWESTERN

FIG. NO.

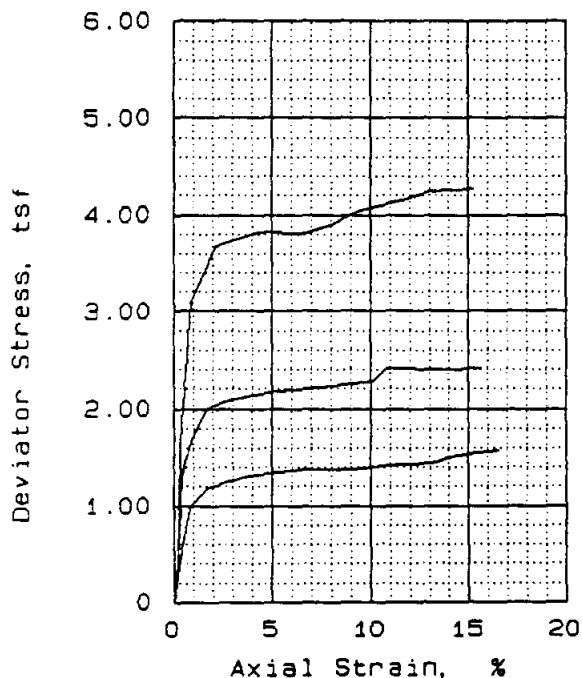
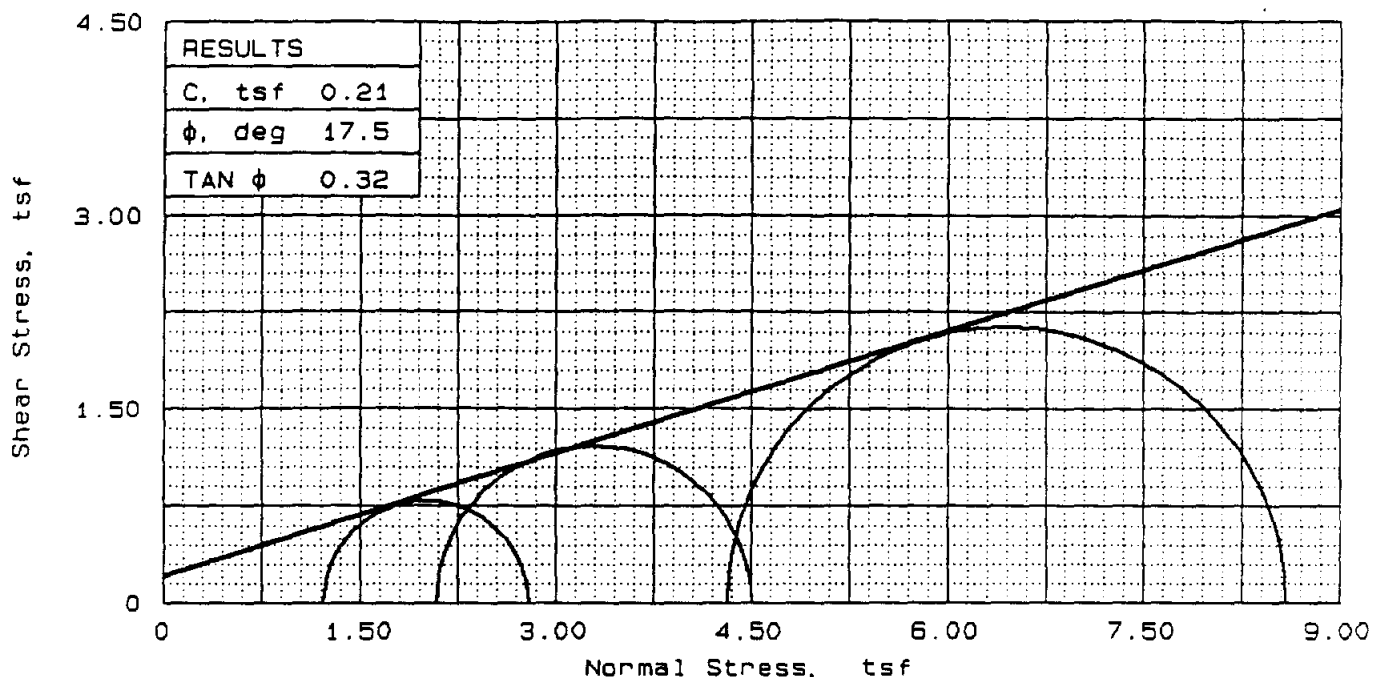

SAMPLE NO.		1	2	3
INITIAL	WATER CONTENT, %	11.7	10.9	10.9
	DRY DENSITY, pcf	112.7	112.6	113.6
	SATURATION, %	64.4	59.6	61.6
	VOID RATIO	0.490	0.492	0.478
	DIAMETER, in	1.38	1.37	1.39
	HEIGHT, in	2.82	3.02	2.98
AT TEST	WATER CONTENT, %	18.7	16.9	16.5
	DRY DENSITY, pcf	111.7	115.5	116.3
	SATURATION, %	100.0	100.0	100.0
	VOID RATIO	0.504	0.454	0.444
	DIAMETER, in	1.39	1.36	1.38
	HEIGHT, in	2.81	3.00	2.95
BACK PRESSURE, tsf		9.07	7.92	7.99
CELL PRESSURE, tsf		10.30	10.01	12.31
FAILURE STRESS, tsf		1.57	2.42	4.26
PORE PRESSURE, tsf				
STRAIN RATE, %/min.		0.050	0.050	0.050
ULTIMATE STRESS, tsf				
PORE PRESSURE, tsf				
$\sigma_1$ FAILURE, tsf		2.80	4.51	8.58
$\sigma_3$ FAILURE, tsf		1.22	2.09	4.32

TYPE OF TEST:  
 Consolidated undrained  
 SAMPLE TYPE: UNDISTURBED  
 DESCRIPTION: SANDY LEAN CLAY  
 (CL)  
 LL= 26      PL= 14      PI= 12.0  
 SPECIFIC GRAVITY= 2.69  
 REMARKS: SPECIFIC GRAVITY  
 ESTIMATED

CLIENT: US ARMY CORPS OF ENGINEERS  
 TULSA DISTRICT  
 PROJECT: PLUM CREEK  
 SAMPLE LOCATION: BORING: PC-8, DB-4  
 9.0-9.9, SWD LAB NO. 91/59  
 PROJ. NO.: 15296      DATE: MARCH 1991

TRIAxIAL COMPRESSION TEST

CORPS OF ENGINEERS - SOUTHWESTERN

FIG. NO.



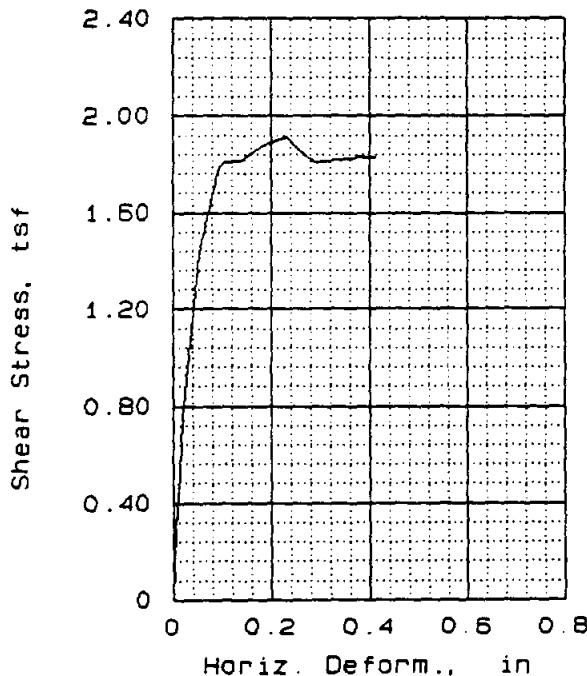
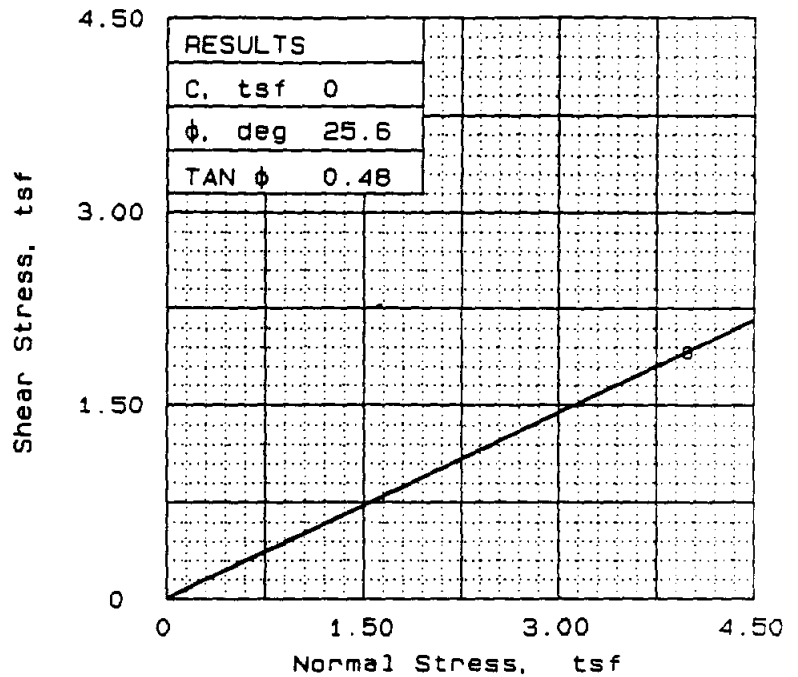
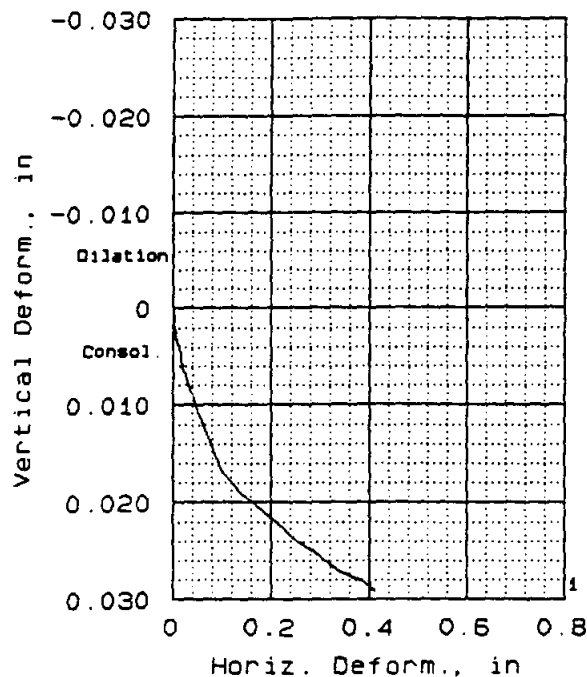

SAMPLE NO.		1
INITIAL	WATER CONTENT, %	19.3
	DRY DENSITY, pcf	107.6
	SATURATION, %	93.0
	VOID RATIO	0.555
	VOID RATIO	0.555
AT TEST	SIDE LENGTH, in	3.00
	HEIGHT, in	1.00
	HEIGHT, in	0.97
NORMAL STRESS, tsf		4.00
MAX. SHEAR, tsf		1.91
STRAIN RATE, %/min.		0.002
ULT. SHEAR, tsf		

**SAMPLE DATA**  
 SAMPLE TYPE: UNDISTURBED  
 DESCRIPTION: LEAN CLAY (CL)  
 LL= 33      PL= 14      PI= 19.0  
 SPECIFIC GRAVITY= 2.68  
 REMARKS: SPECIFIC GRAVITY  
 ESTIMATED  
 FIG. NO.

CLIENT: US ARMY CORPS OF ENGINEERS  
 TULSA DISTRICT  
 PROJECT: PLUM CREEK  
 FOUNDATION MATERIALS  
 SAMPLE LOCATION: PC-5, DB-1  
 2.1-2.9, SWD-LAB NO. 91/31  
 PROJ. NO.: 15296      DATE: MARCH 1991  
 DIRECT SHEAR TEST  
**CORPS OF ENGINEERS - SOUTHWESTERN**

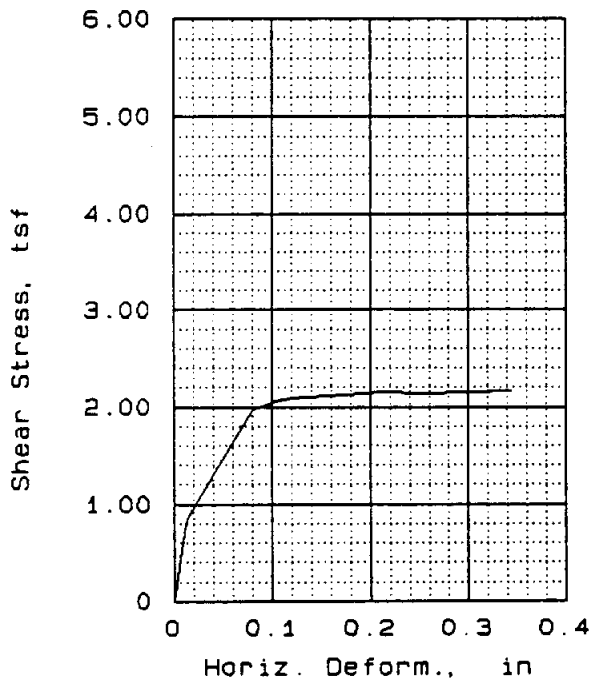
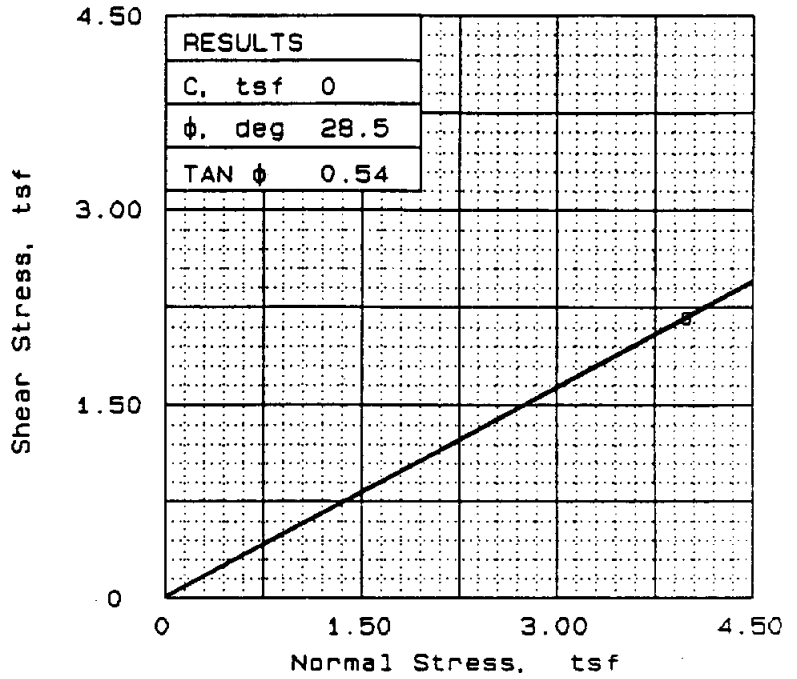
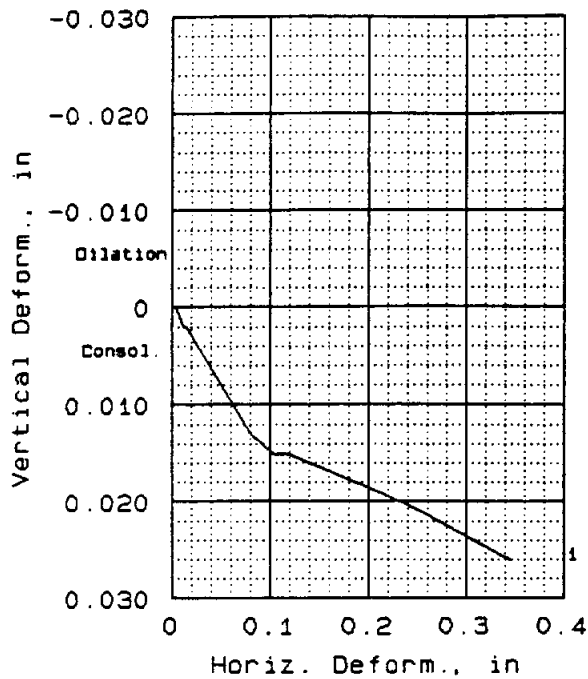

SAMPLE NO.		1
INITIAL	WATER CONTENT, %	18.6
	DRY DENSITY, pcf	108.4
	SATURATION, %	91.7
	VOID RATIO	0.544
	SIDE LENGTH, in	3.00
	HEIGHT, in	1.00
AT TEST	WATER CONTENT, %	16.9
	DRY DENSITY, pcf	109.6
	SATURATION, %	86.2
	VOID RATIO	0.527
	SIDE LENGTH, in	3.39
	HEIGHT, in	0.99
NORMAL STRESS, tsf		4.00
MAX. SHEAR, tsf		2.17
STRAIN RATE, %/min.		0.002
ULT. SHEAR, tsf		

**SAMPLE DATA**

SAMPLE TYPE: UNDISTURBED  
 DESCRIPTION: LEAN CLAY WITH SAND (CL)  
 LL= 27      PL= 13      PI= 14.0  
 SPECIFIC GRAVITY= 2.68  
 REMARKS: SPECIFIC GRAVITY ESTIMATED

CLIENT: US ARMY CORPS OF ENGINEERS  
 TULSA DISTRICT  
 PROJECT: PLUM CREEK  
 FOUNDATION MATERIALS  
 SAMPLE LOCATION: PC-5. DB-3  
 6.3-7.1, SWD-LAB NO. 91/33

PROJ. NO.: 15296      DATE: MARCH 1991

DIRECT SHEAR TEST

**CORPS OF ENGINEERS - SOUTHWESTERN**

FIG. NO.

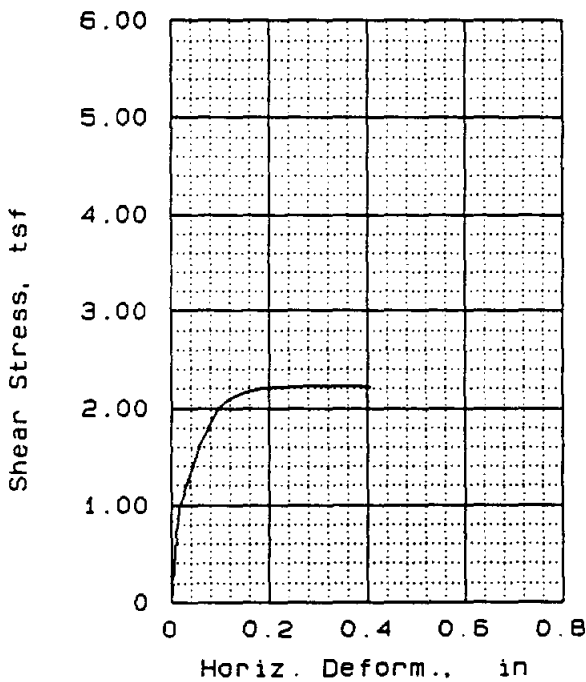
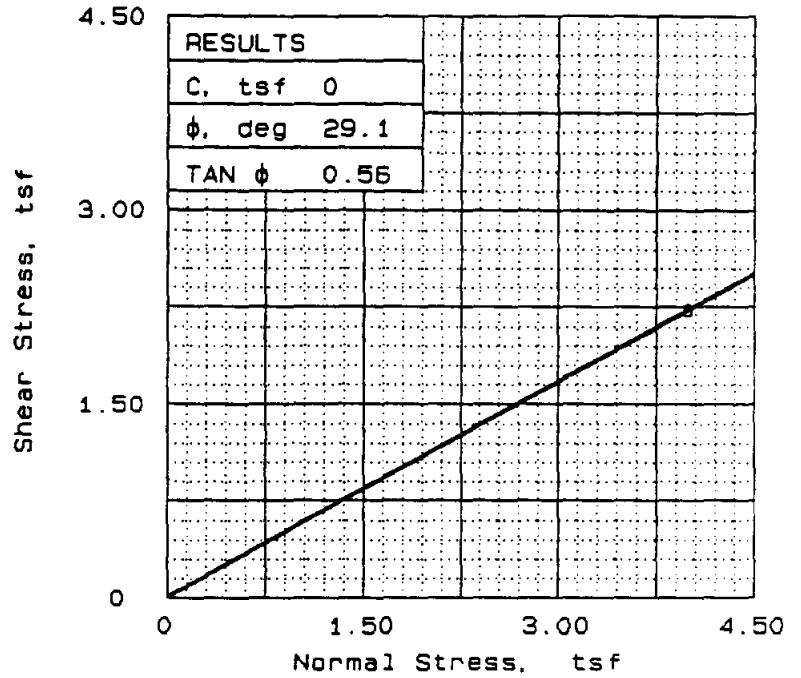
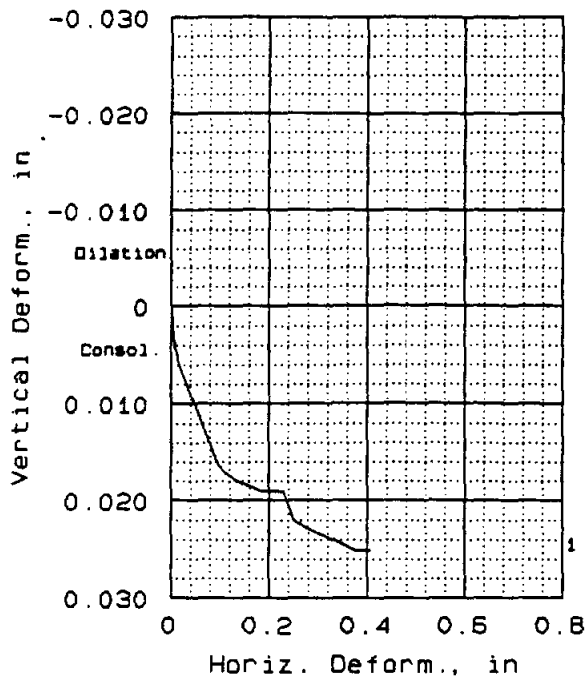

SAMPLE NO.		1
INITIAL	WATER CONTENT, %	13.7
	DRY DENSITY, pcf	112.1
	SATURATION, %	74.4
	VOID RATIO	0.492
	SIDE LENGTH, in	3.00
HEIGHT, in	1.00	
AT TEST	WATER CONTENT, %	16.8
	DRY DENSITY, pcf	113.7
	SATURATION, %	95.5
	VOID RATIO	0.471
	SIDE LENGTH, in	3.39
HEIGHT, in	0.99	
NORMAL STRESS, tsf		4.00
MAX. SHEAR, tsf		2.23
STRAIN RATE, %/min.		0.002
ULT. SHEAR, tsf		

**SAMPLE DATA**  
 SAMPLE TYPE: UNDISTURBED  
 DESCRIPTION: SANDY LEAN CLAY (CL)  
 LL= 26      PL= 14      PI= 12.0  
 SPECIFIC GRAVITY= 2.68  
 REMARKS: SPECIFIC GRAVITY ESTIMATED

CLIENT: US ARMY CORPS OF ENGINEERS  
 TULSA DISTRICT  
 PROJECT: PLUM CREEK  
 FOUNDATION MATERIALS  
 SAMPLE LOCATION: PC-8, DB-4  
 9.0-9.9, SWD-LAB NO. 91/59  
 PROJ. NO.: 15296      DATE: MARCH 1991

DIRECT SHEAR TEST

**CORPS OF ENGINEERS - SOUTHWESTERN**

FIG. NO.

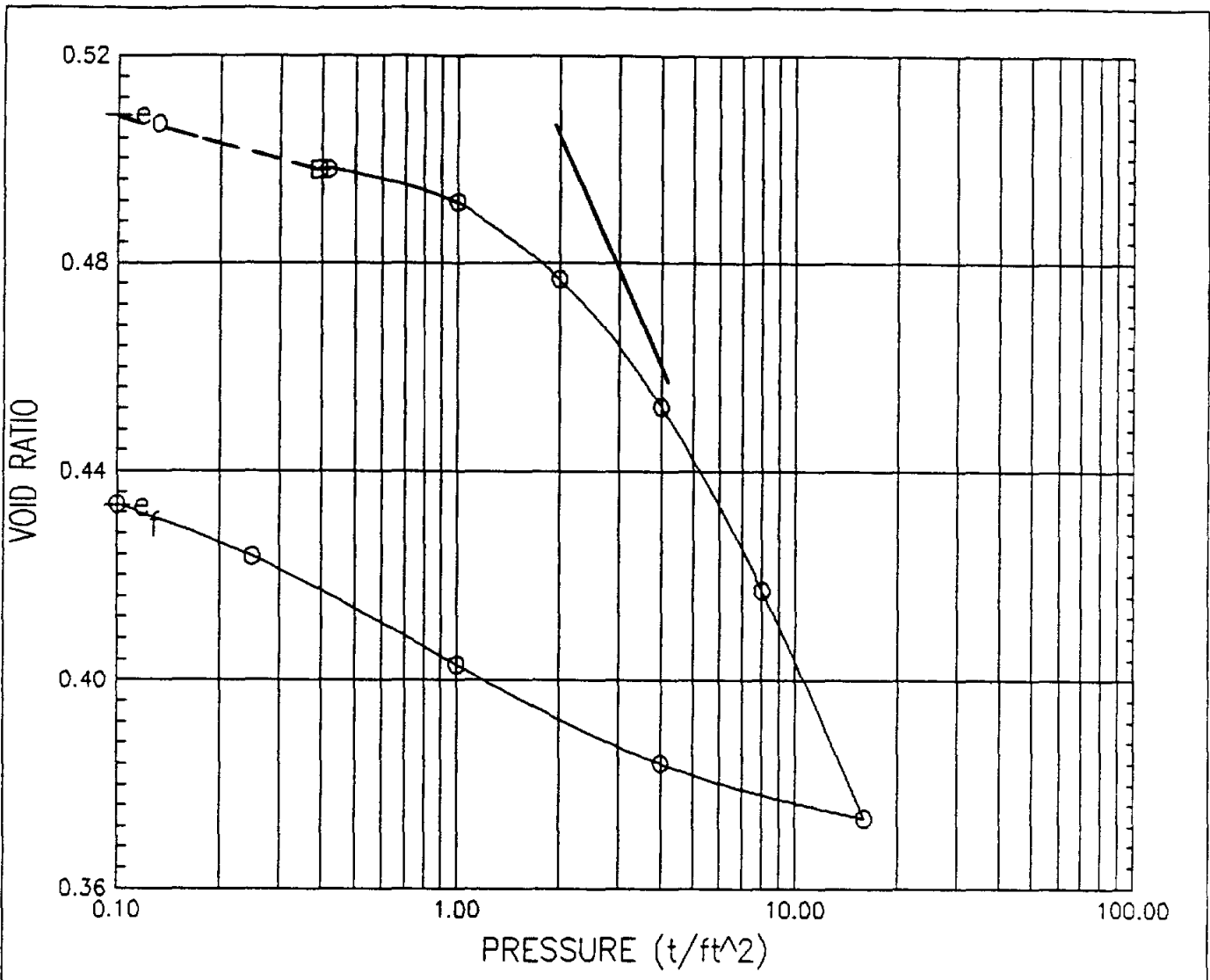

		BEFORE TEST	AFTER TEST
OVERBURDEN PRESSURE ( $t/ft^2$ )	0.4	WATER CONTENT (%)	18.136
PRECONSOL. PRESSURE ( $t/ft^2$ )		DRY DENSITY ( $lb/ft^3$ )	110.885
COMPRESSION INDEX	0.15	SATURATION (%)	95.523
TYPE SPECIMEN		VOID RATIO	0.509
DIA. (in) 4.430	HT. (in) 1.000	BACK PRESSURE ( $t/ft^2$ )	0.434
CLASSIFICATION LEAN CLAY WITH SAND (CL)			
LL 27.0	PL 13.0	PI 14.0	PROJECT PLUM CREEK FOUNDATION MT
GS 2.680	$D_{10}$	Data File: B:33.CMV	
REMARKS		BORING NO. PC-5	SAMPLE NO. 91/33
<input type="checkbox"/> Start-Swell <input type="checkbox"/> End-Swell		DEPTH 6.3-7.1	DATE
Army Corp of Engineers CONSOLIDATION TEST REPORT			

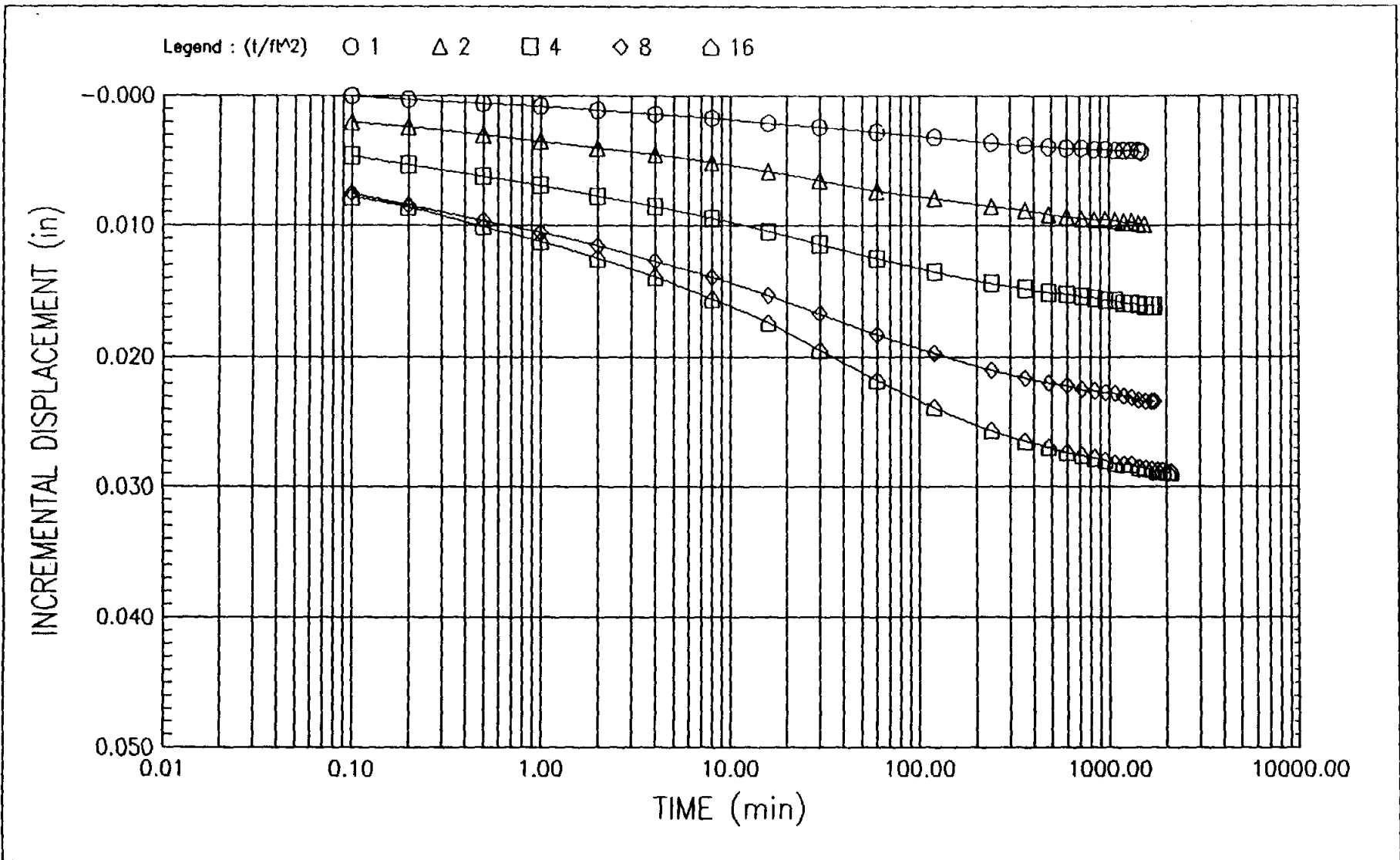

PROJECT	PLUM CREEK FOUNDATION MT		
	Data File: B:33.CNV		
BORING	PC-5	SAMPLE NO.	91/33
DEPTH	6.3-7.1	DATE	

Army Corp of Engineers  
 CONSOLIDATION TEST  
 TIME CURVES

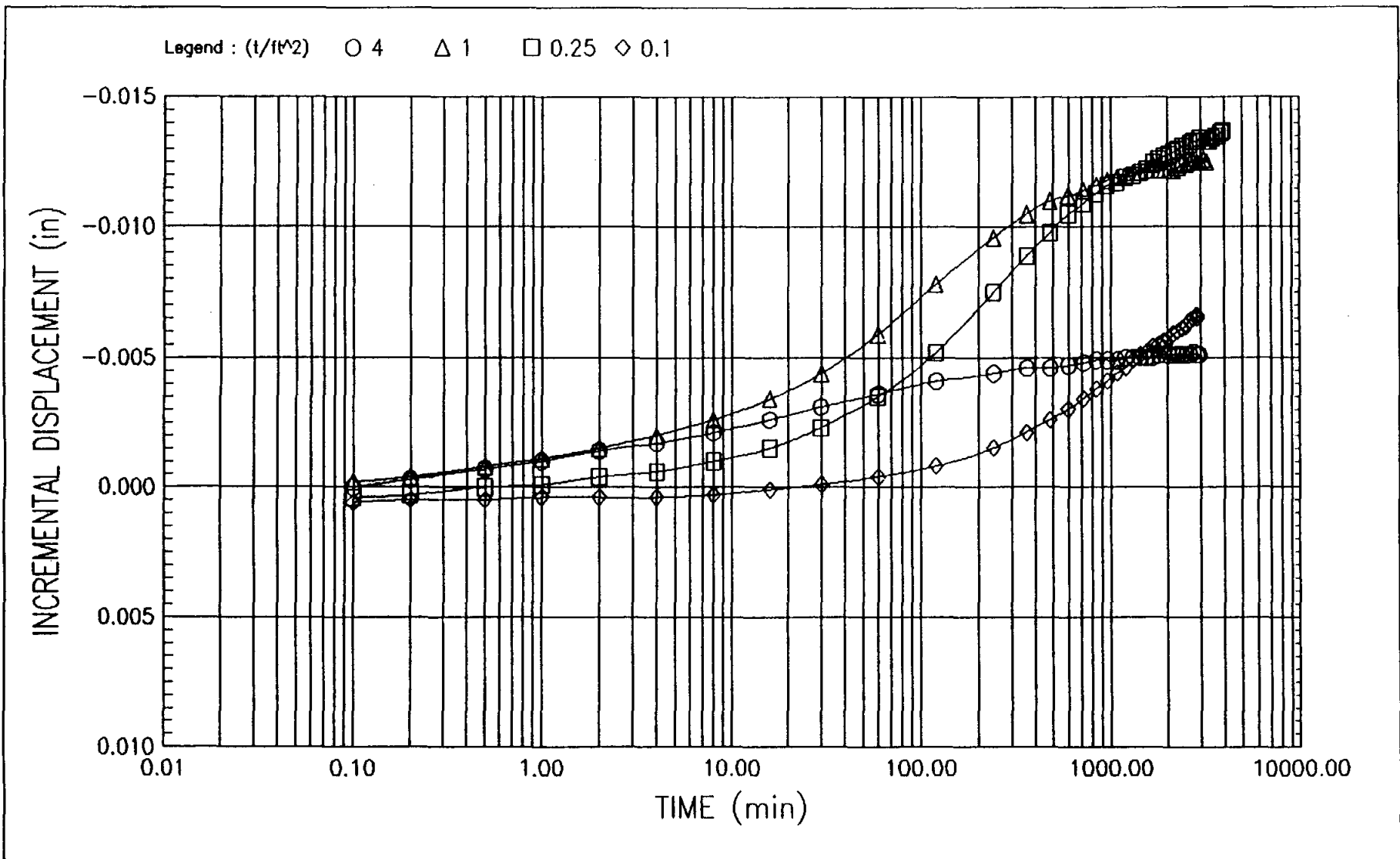

PROJECT	PLUM CREEK FOUNDATION MT		Army Corp of Engineers CONSOLIDATION TEST TIME CURVES
	Data File: B:33.CNV		
BORING	PC-5	SAMPLE NO. 91/33	
DEPTH	6.3-7.1	DATE	

**APPENDIX C**

**SWDED-GL REPORT NO. 15299**

**BORROW MATERIAL**

SOUTHWESTERN DIVISION LABORATORY, CORPS OF ENGINEERS  
4815 Cass Street  
Dallas, Texas 75235

SUBMITTAL OF SWDED-GL REPORT 15299 ( 25 pages)

PROJECT: PLUM CREEK : Contract No.  
Feature: BORROW AREA :

TEST REQUEST NO.: PN 91-24 : From: CHIEF  
Dated: 08 MAR 1991 : GEOTECHNICAL BRANCH  
Received: 22 MAR 1991 : TULSA DISTRICT

MATERIAL: DISTURBED SOIL SAMPLES

No. and type of samples: 114 JARS AND 6 BAGS.

Source or other identification: BORINGS: PT-1 THRU 14, PT-17  
THRU 21, AND PT-23 THRU 27.

Date received: 22 FEB 1991.

REMARKS: ALL TESTS HAVE BEEN PERFORMED IN ACCORDANCE WITH EM 1110-  
2-1906. SAMPLES WITH GRAIN SIZE DISTRIBUTION AND ATTERBERG  
LIMITS TESTS HAVE BEEN CLASSIFIED IN ACCORDANCE WITH MIL  
STD. 619B. ALL OTHER SAMPLES HAVE BEEN VISUALLY CLASSIFIED ONLY.

RESULTS OF TESTS	TABLE 1
PLASTICITY CHART	PLATE 1
COMPACTION TESTS	PLATES 2-3
TRIAXIAL COMPRESSION TESTS, Q-TYPE	PLATES 4-9
TRIAXIAL COMPRESSION TESTS, R-TYPE	PLATES 10-15
DIRECT SHEAR TESTS	PLATES 16-21

Report sent to: : Copy furnished:  
TULSA DISTRICT :

Date: : Name and title: : Signature  
26 June 1991 : WILLIAM R. TANNER :  
: Director :  
: SWD Laboratory : 



TABLE 1  
RESULTS OF TESTS OF DISTURBED AND UNDISTURBED SOIL SAMPLES

SWED-6L REPORT NO. 15299 PLUM CREEK - BORROW AREA

BORING	NO.	SWD NO.	FLD NO.	DEPTH, FT	GR	SA	FI	LL	PL	PI	LS	WC, %	PCF	MAJOR TESTS	DESCRIPTION OF MATERIAL
PT	1	91/ 169	JAR-1	0.0 - 3.2	0	54	46				0	13.0			SM - SILTY SAND, DARK BROWN, VERY MOIST, ROOTS, FINE SAND.
PT	1	91/ 170	JAR-2	3.2 - 6.0	0	65	35					9.4			- SILTY SAND, YELLOWISH RED, VERY MOIST, FINE SAND.
PT	1	91/ 171	JAR-3	6.0 - 9.0	0	81	19				0	8.2			SM - SILTY SAND, REDDISH YELLOW, VERY MOIST, FINE SAND.
PT	1	91/ 172	JAR-4	9.0 - 11.0	0	39	61					14.7			- SANDY LEAN CLAY, YELLOWISH RED, MOIST, FINE SAND, SOME SMALL BLACK NODULES.
PT	1	91/ 173	JAR-5	11.0 - 12.0	1	34	65	33	12	21		14.8			CL - SANDY LEAN CLAY, REDDISH BROWN, MOIST, CALCAREOUS, SOME SMALL BLACK NODULES.
PT	2	91/ 174	JAR-1	0.0 - 2.0	0	34	66					14.9			- SANDY SILT, DARK BROWN, VERY MOIST, SOME ROOTS
PT	2	91/ 175	JAR-2	2.0 - 3.4	0	30	70	24	12	12		14.4			CL - SANDY LEAN CLAY, DARK REDDISH BROWN, VERY MOIST, FINE SAND.
PT	2	91/ 176	JAR-3	3.4 - 6.1	0	56	44					7.8			- CLAYEY SAND, YELLOWISH RED, MOIST, FINE SAND.
PT	2	91/ 177	JAR-4	6.1 - 9.2	0	49	51	20	17	3		8.0			ML - SANDY SILT, YELLOWISH RED AND REDDISH YELLOW, MOIST, FINE SAND, SMALL AMOUNT OF CLAY.
PT	2	91/ 178	JAR-5	9.2 - 9.8	13	37	50					12.1			- SANDY LEAN CLAY, DARK YELLOWISH RED AND REDDISH BROWN, MOIST, FINE SAND, NUMEROUS CALC NODULES AND BLACK NODULES, TWO GRAVELS TO 1 1/2".
PT	3	91/ 179	JAR-1	0.0 - 2.0	0	33	67	27	14	13		18.3			CL - SANDY LEAN CLAY, BROWN AND REDDISH BROWN, MOIST, ROOT, FINE SAND.
PT	3	91/ 180	JAR-2	2.0 - 6.0	0	29	71					9.9			- SANDY LEAN CLAY, GRAYISH BROWN, DAMP TO MOIST, FINE SAND, SMALL AMOUNT OF CHALKY MATERIAL.
PT	3	91/ 181	JAR-3	6.0 - 8.3	2	55	43	19	15	4		8.6			SC-SM - SILTY CLAYEY SAND, REDDISH YELLOW WITH SOME LIGHT YELLOWISH BROWN, MOIST, COARSE TO FINE SAND.
PT	3	91/ 182	JAR-4	8.3 - 10.5	0	54	46					7.2			- CLAYEY SAND, REDDISH YELLOW, MOIST, CALCAREOUS, COARSE TO FINE SAND.
PT	4	91/ 183	JAR-1	0.0 - 1.9	0	38	62	39	16	23		19.7			CL - SANDY LEAN CLAY, REDDISH BROWN, MOIST, CALCAREOUS, ROOTS, FINE SAND.
PT	4	91/ 184	JAR-2	1.9 - 4.0	0	37	63					15.7			- SANDY LEAN CLAY, REDDISH BROWN AND YELLOWISH RED, MOIST, TINY ROOTS, FINE SAND.
PT	4	91/ 185	JAR-3	4.0 - 6.5	2	58	40				1	7.0			SM - SILTY SAND, RED TO YELLOWISH RED, MOIST, COARSE TO FINE SAND.
PT	4	91/ 186	JAR-4	6.5 - 9.0	1	66	33					8.7			- CLAYEY SAND, DARK RED, MOIST, SLIGHTLY CALCAREOUS, FEW CALCAREOUS PARTICLES, COARSE TO FINE SAND.
PT	4	91/ 187	JAR-5	9.0 - 11.0	1	58	41	23	13	10		10.1			SC - CLAYEY SAND, RED TO DARK RED, MOIST, SLIGHTLY CALCAREOUS, FEW CALCAREOUS GRAVELS, COARSE TO FINE SAND.
PT	4	91/ 188	JAR-6	11.0 - 11.5	2	39	59					9.7			- SANDY LEAN CLAY, DARK RED TO RED, MOIST, A FEW CALCAREOUS GRAVELS, COARSE TO FINE SAND.
PT	5	91/ 189	JAR-1	0.0 - 1.8	0	23	77	35	16	19		24.2			CL - LEAN CLAY WITH SAND, BROWN, MOIST, FEW TINY ROOTS.
PT	5	91/ 190	JAR-2	1.8 - 5.0	3	32	65					10.0			- SANDY LEAN CLAY, LIGHT OLIVE BROWN AND OLIVE YELLOW, SMALL AMOUNT OF WHITE CALCAREOUS MATERIAL,
PT	5	91/ 191	JAR-3	5.0 - 7.0	1	30	69	31	12	19		13.8			- SHALE, REDDISH BROWN AND LIGHT YELLOWISH BROWN, MOIST, WEATHERED, CALCAREOUS, SOME FINE SAND, SOME SLICKENSIDES.
PT	5	91/ 192	JAR-4	7.0 - 10.2	0	25	75					10.2			- SHALE, DARK RED, MOIST, CALCAREOUS, SOME FINE SAND, FEW GRAY-GREEN SPECKS.
PT	6	91/ 193	JAR-1	0.0 - 2.3	0	28	72	21	16	5		17.4			CL-ML - SILTY CLAY WITH SAND, DARK BROWN TO DARK GRAYISH BROWN, MOIST, SLIGHTLY CALCAREOUS, SOME TINY ROOTS, FINE SAND.
PT	6	91/ 194	JAR-2	2.3 - 4.9	0	35	65					9.2			- SANDY LEAN CLAY, GRAYISH BROWN TO DARK GRAYISH BROWN, MOIST, SLIGHTLY CALCAREOUS, WHITE CALCAREOUS SPECKS THROUGHOUT, FINE SAND.
PT	6	91/ 195	JAR-3	4.9 - 6.5	0	38	62	30	11	19		10.2			CL - SANDY LEAN CLAY, REDDISH BROWN AND BROWN, MOIST, CALCAREOUS, SOME SHALE CHARACTERISTICS.
PT	6	91/ 196	JAR-4	6.5 - 9.5	0	54	46					8.9			- SHALE, DARK RED, MOIST, SLIGHTLY CALCAREOUS, SOME FINE SAND, FEW GRAY-GREEN SPECKS.
PT	7	91/ 197	JAR-1	0.0 - 3.0	0	26	74				1	16.7			ML - SILT WITH SAND, DARK BROWN, MOIST, SOME TINY ROOTS.
PT	7	91/ 198	JAR-2	3.0 - 8.0	0	29	71					12.7			- SANDY LEAN CLAY, DARK BROWN TO DARK BROWN, MOIST, FINE SAND.
PT	7	91/ 199	JAR-3	8.0 - 9.5	1	37	62	27	12	15		12.0			CL - SANDY LEAN CLAY, REDDISH BROWN, MOIST, SLIGHTLY CALCAREOUS, SCATTERED GRAYISH-GREEN SILTY SAND.
PT	7	91/ 200	JAR-4	9.5 - 10.5	0	32	68					13.4			- LEAN CLAY, REDDISH BROWN, MOIST, SLIGHTLY CALCAREOUS, SOME FINE SAND, SOME GRAYISH-GREEN SPLOTCHES, SHALE CHARACTERISTICS.
PT	7	91/ 201	JAR-5	10.5 - 11.3	0	8	92	33	14	19		12.0			- SHALE, REDDISH BROWN, MOIST, CALCAREOUS, SMALL AMOUNT OF FINE SAND, FEW GRAY-GREEN SPECKS.
PT	8	91/ 202	JAR-1	0.0 - 1.0	0	44	56					16.4			- SANDY SILT, DARK BROWN, MOIST, SMALL AMOUNT OF CLAY, SOME SMALL ROOTS, FINE SAND.
PT	8	91/ 203	JAR-2	1.0 - 4.4	0	65	35				1	10.3			SM - SILTY SAND, YELLOWISH RED, MOIST, SOME FINE ROOTS, FINE SAND.
PT	8	91/ 204	JAR-3	4.4 - 6.6	0	39	61					10.5			- SANDY LEAN CLAY, REDDISH BROWN, MOIST, SLIGHTLY CALCAREOUS, FINE SAND.
PT	8	91/ 205	JAR-4	6.6 - 7.6	0	89	11				0	3.0			SP-SM - POORLY GRADED SAND WITH SILT, REDDISH BROWN, MOIST, FINE SAND.
PT	8	91/ 206	JAR-5	7.6 - 9.5	1	42	57					13.7			- SANDY CLAY, REDDISH BROWN AND GRAYISH BROWN, MOIST, SLIGHTLY CALCAREOUS.
PT	8	91/ 207	JAR-6	9.5 - 10.5	0	53	47	23	12	11		10.0			SC - CLAYEY SAND, YELLOWISH RED AND GRAYISH GREEN, MOIST, SLIGHTLY CALCAREOUS, SOME SOFT BLACK NODULES, FEW CHUNKS OF SHALE.
PT	8	91/ 208	JAR-7	10.5 - 11.4	0	52	48					11.1			- SHALE, YELLOWISH RED, AND GRAYISH GREEN, MOIST, LOOSE SAND SURROUNDING SHALE CHUNK.

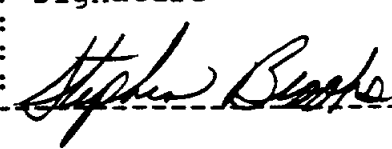
TABLE 1  
RESULTS OF TESTS OF DISTURBED AND UNDISTURBED SOIL SAMPLES

SWD-GL REPORT NO. 15299 PLUM CREEK - BORROW AREA

BORING	NO.	SMD NO.	FLD NO.	DEPTH, FT	GR	SA	FI	LL	PL	PI	LS	WC, %	PCF	MAJOR TESTS	DESCRIPTION OF MATERIAL
PT	9	91/ 209	JAR-1	0.0 - 3.0	0	17	83	36	15	21		21.5		CL	LEAN CLAY WITH SAND, BROWN, MOIST, CALCAREOUS.
PT	9	91/ 210	JAR-2	3.0 - 6.3	5	37	58					12.0		-	SANDY LEAN CLAY, REDDISH YELLOW AND LIGHT YELLOWISH BROWN, MOIST, CALCAREOUS, SOME SHALE, SCATTERED WHITE CALCAREOUS MATERIAL THROUGHOUT.
PT	9	91/ 211	JAR-3	6.3 - 8.0	0	44	56	29	15	14		12.3		-	SANDY LEAN CLAY, YELLOWISH RED AND LIGHT YELLOWISH BROWN, MOIST, CALCAREOUS, SOME RUST COLOR, MEDIUM TO COARSE SAND THROUGHOUT, FEW CALCAREOUS NODULES TO 3/8".
PT	9	91/ 212	JAR-4	8.0 - 11.2	0	65	35					9.2		-	SHALE, RED, MOIST, RUST COLOR SAND THROUGHOUT, SOME BLACK NODULES.
PT	9	91/ 213	JAR-5	11.2 - 11.8	0	67	33	36	15	21		8.2		-	SHALE, RED, MOIST, RUST COLOR SAND THROUGHOUT, SOME BLACK NODULES.
PT	10	91/ 214	JAR-1	0.0 - 2.0	1	23	76					19.8		-	LEAN CLAY WITH SAND, DARK BROWN, MOIST, FEW ROOTS.
PT	10	91/ 215	JAR-2	2.0 - 5.0	0	22	78	27	14	13		11.6		CL	LEAN CLAY WITH SAND, BROWN TO DARK BROWN, MOIST, SMALL AMOUNT OF FINE SAND, SCATTERED WHITE CALCAREOUS MATERIAL.
PT	10	91/ 216	JAR-3	5.0 - 6.1	1	31	68					13.0		-	SANDY LEAN CLAY, LIGHT OLIVE BROWN AND BROWNISH YELLOW, MOIST.
PT	10	91/ 217	JAR-4	6.1 - 9.5	0	37	63				1	12.4		ML	SANDY SILT, REDDISH BROWN, LIGHT BROWNISH GRAY AND YELLOWISH RED, MOIST.
PT	10	91/ 218	JAR-5	9.5 - 12.1	1	50	49					6.7		-	CLAYEY SAND, RED TO YELLOWISH RED, MOIST, BLACK STEAKING THROUGHOUT.
PT	11	91/ 219	JAR-1	0.0 - 2.0	0	31	69				1	15.4		ML	SANDY SILT, DARK BROWN TO DARK REDDISH BROWN, MOIST, FEW TINY ROOTS, FINE SAND.
PT	11	91/ 220	JAR-2	2.0 - 4.0	0	32	68					20.4		-	SANDY LEAN CLAY, REDDISH BROWN TO DARK REDDISH BROWN, MOIST, SLIGHTLY CALCAREOUS, TINY ROOTS, FEW BLACK NODULES.
PT	11	91/ 221	JAR-3	4.0 - 7.0	0	35	65	35	13	22		10.2		CL	SANDY LEAN CLAY, YELLOWISH RED, MOIST, FEW BLACK NODULES.
PT	11	91/ 222	JAR-4	7.0 - 9.0	1	50	49					6.4		-	CLAYEY SAND, RED TO REDDISH BROWN, MOIST, CALCAREOUS.
PT	11	91/ 223	JAR-5	9.0 - 9.4										-	SANDSTONE, GRAYISH BROWN, SOFT (ROCK CLASS.), CALCAREOUS, SOME REDDISH BROWN CLAYEY SAND.
PT	12	91/ 224	JAR-1	0.0 - 2.9	0	35	65					10.3		-	SANDY LEAN CLAY, REDDISH BROWN, MOIST.
PT	12	91/ 225	JAR-2	2.9 - 6.5	0	42	58				2	8.6		ML	SANDY SILT, REDDISH BROWN, MOIST.
PT	12	91/ 226	JAR-3	6.5 - 7.6	11	50	39					6.3		-	CLAYEY SAND, RED TO REDDISH BROWN, MOIST, CALCAREOUS, WHITE CHALKY MATERIAL THROUGHOUT, FEW BLACK GRAVELS TO 3/8".
PT	12	91/ 227	JAR-4	7.6 - 7.9										-	SANDSTONE, YELLOWISH BROWN, SOFT (ROCK CLASS.), CALCAREOUS.
PT	13	91/ 228	JAR-1	0.0 - 2.6	0	58	42					14.7		-	CLAYEY SAND, YELLOWISH RED AND GRAYISH BROWN, MOIST, FEW ROOTS.
PT	13	91/ 229	JAR-2	2.6 - 3.5	3	66	31				1	7.1		SM	SILTY SAND, BROWN, AND REDDISH BROWN, MOIST, SOME BLACK NODULES.
PT	13	91/ 230	JAR-3	3.5 - 6.0	0	35	65					12.0		-	SANDY LEAN CLAY, DARK REDDISH BROWN, MOIST, SOME CALCAREOUS AND BLACK NODULES THROUGHOUT.
PT	13	91/ 231	JAR-4	6.0 - 9.0	1	36	63	34	14	20		14.2		CL	SANDY LEAN CLAY, YELLOWISH RED, MOIST, CALCAREOUS, BLACK NODULES, SOME SHALE CHUNK THROUGHOUT.
PT	13	91/ 232	JAR-5	9.0 - 9.8	0	18	82					15.1		-	SHALE, DARK REDDISH BROWN, MOIST, BLACK IRON STAINING.
PT	13	91/ 233	JAR-6	9.8 - 10.9	5	22	73	24	13	11		10.2		-	SHALE, DARK REDDISH BROWN AND GRAYISH GREEN, MOIST, SLIGHTLY CALCAREOUS, LARGE GRAYISH GREEN SANDY SILT CHUNKS.
PT	14	91/ 234	JAR-1	0.0 - 2.0	0	43	57					17.5		-	SANDY LEAN CLAY, BROWN TO YELLOWISH BROWN, MOIST, TINY ROOTS, FINE SAND, LOW LIMIT MATERIAL.
PT	14	91/ 235	JAR-2	2.0 - 5.0	0	38	62	22	14	8		9.0		CL	SANDY LEAN CLAY, BROWN TO YELLOWISH BROWN, DAMP TO MOIST, SMALL BLACK NODULES, FINE SAND.
PT	14	91/ 236	JAR-3	7.2 - 9.0	0	13	87	31	13	19		6.9		-	SHALE, REDDISH BROWN AND GRAYISH GREEN, DAMP, CALCAREOUS, GRAYISH GREEN CHUNK.
PT	14	91/ 237	JAR-4	9.0 - 11.0	0	2	98	42	16	26		10.4		-	SHALE, DARK REDDISH BROWN, MOIST.
PT	17	91/ 238	JAR-1	0.0 - 3.0	0	57	43					11.2		-	SILTY SAND, DARK BROWN, MOIST, FINE SAND.
PT	17	91/ 239	JAR-2	3.0 - 8.4	0	65	35				2	7.1		SM	SILTY SAND, REDDISH YELLOW, MOIST, SMALL AMOUNT OF CLAY.
PT	17	91/ 240	JAR-3	8.4 - 10.0	6	32	62					14.3		-	SANDY LEAN CLAY, REDDISH BROWN, MOIST, CALCAREOUS, SOME SMALL GRAVELS TO 3/8", BLACK NODULES.
PT	17	91/ 241	JAR-4	10.0 - 11.5	1	28	71	24	12	12		16.9		CL	LEAN CLAY WITH SAND, YELLOWISH RED, MOIST, SLIGHTLY CALCAREOUS, SMALL LENSES OF SAND.
PT	18	91/ 242	JAR-1	0.0 - 2.9	0	27	73					18.9		-	LEAN CLAY WITH SAND, DARK BROWN TO REDDISH BROWN, MOIST, FINE SAND.
PT	18	91/ 243	JAR-2	2.9 - 6.0	2	41	57	23	12	11		11.3		CL	SANDY LEAN CLAY, YELLOWISH BROWN, MOIST, WHITE HIGHLY CALCAREOUS CHALKY MATERIAL THROUGHOUT
PT	18	91/ 244	JAR-3	6.0 - 10.0	1	44	55					10.5		-	SANDY LEAN CLAY, REDDISH YELLOW, MOIST.
PT	18	91/ 245	JAR-4	10.0 - 11.0	0	50	50				1	9.9		ML	SANDY SILT, RED TO DARK RED, MOIST, BLACK NODULES TO 1/2".
PT	19	91/ 246	JAR-1	0.0 - 2.5	1	20	79					18.4		-	LEAN CLAY, REDDISH BROWN, MOIST, FEW GRAVEL TO 3/8", FINE SAND.
PT	19	91/ 247	JAR-2	2.5 - 5.1	3	29	68	25	17	8		11.7		CL	SANDY LEAN CLAY, BROWN YELLOW AND GRAYISH BROWN, MOIST, SLIGHTLY CALCAREOUS, SMALL POCKETS AND LENSES OF SAND, FEW ROOTS.
PT	19	91/ 248	JAR-3	5.1 - 9.0	1	27	62					10.1		-	SANDY LEAN CLAY, YELLOWISH RED, MOIST, CALCAREOUS, HARD BLACK NODULES.

TABLE 1  
RESULTS OF TESTS OF DISTURBED AND UNDISTURBED SOIL SAMPLES

SWDED-GL REPORT NO. 15299 PLUM CREEK - BORROW AREA

BORING	NO.	SWD NO.	FLD NO.	DEPTH, FT	GR	SA	FI	LL	PL	PI	LS	WC, %	PCF	MAJOR TESTS	DESCRIPTION OF MATERIAL
PT	19	91/ 249	JAR-4	8.0 - 9.5	0	27	73	26	12	14		10.0			CL - LEAN CLAY WITH SAND, YELLOWISH RED AND REDDISH BROWN, MOIST, SMALL LENSES OF FINE SAND.
PT	19	91/ 250	JAR-5	9.5 - 10.7	0	30	70					9.0			- LEAN CLAY WITH SAND, YELLOWISH RED AND REDDISH BROWN, MOIST, SMALL LENSES OF FINE SAND.
PT	20	91/ 251	JAR-1	0.0 - 1.5	0	64	36	27	13	14		14.9			SC - CLAYEY SAND, YELLOWISH RED AND REDDISH BROWN, MOIST, TINY ROOTS, SOME SANDSTONE PARTICLES TO 1/2" BLACK NODULES.
PT	20	91/ 252	JAR-2	1.5 - 3.0	0	50	50					14.0			- SANDY LEAN CLAY, OLIVE YELLOW AND LIGHT OLIVE BROWN, MOIST, SANDSTONE PARTICLES TO 1/2".
PT	20	91/ 253	JAR-3	3.0 - 5.5								5.1			- SANDSTONE, LIGHT YELLOWISH BROWN, DRY, SOFT (ROCK CLASS.), SOME CLAY, SANDSTONE PARTICLES 2 1/2"
PT	21	91/ 254	JAR-1	0.0 - 2.0	0	25	75					20.8			- SILT WITH SAND, DARK BROWN, VERY MOIST, SOME TINY ROOTS.
PT	21	91/ 255	JAR-2	2.0 - 3.8	0	43	57			0		25.4			ML - SANDY SILT, DARK BROWN, WET, ROOTS, ORGANIC ODOR.
PT	21	91/ 256	JAR-3	3.8 - 5.0	0	38	62					15.1			- SANDY LEAN CLAY, DARK BROWN TO LIGHT BROWN, MOIST, SLIGHTLY CALCAREOUS.
PT	23	91/ 257	JAR-1	0.0 - 2.0	0	44	56	32	16	16		15.5			CL - SANDY LEAN CLAY, DARK BROWN TO LIGHT BROWN, MOIST, SLIGHTLY CALCAREOUS.
PT	23	91/ 258	JAR-2	2.0 - 4.0	0	69	31					10.8			- SILTY SAND, YELLOWISH RED AND REDDISH BROWN, MOIST, SMALL AMOUNT OF CLAY.
PT	23	91/ 259	JAR-3	4.0 - 7.8	1	54	45	24	11	13	3	8.7			SC - CLAYEY SAND, YELLOWISH RED AND LIGHT BROWNISH GRAY, MOIST.
PT	23	91/ 260	JAR-4	7.8 - 10.5	0	48	52					13.8			- SANDY LEAN CLAY, RED, MOIST, CALCAREOUS, SOME BLACK NODULES.
PT	23	91/ 261	JAR-5	10.5 - 11.0	48	37	15	22	11	11		9.2			GC - CLAYEY GRAVEL WITH SAND, DARK RED, MOIST, CALCAREOUS, BLACK GRAVEL TO 1"
PT	23	91/ 262	JAR-6	11.0 - 11.7	7	22	71					12.5			- LEAN CLAY WITH SAND, DARK REDDISH BROWN, MOIST, CALCAREOUS, BLACK GRAVELS TO 3/4".
PT	24	91/ 263	JAR-1	0.0 - 2.5	0	38	62				2	16.7			ML - SANDY SILT, DARK REDDISH BROWN, MOIST, SOME TINY ROOTS, FINE SAND.
PT	24	91/ 264	JAR-2	2.5 - 4.2	0	40	60					11.9			- SANDY LEAN CLAY, GRAYISH BROWN AND REDDISH BROWN, MOIST, FINE SAND LENSES, FEW BLACK NODULES.
PT	24	91/ 265	JAR-3	4.2 - 7.7	0	49	51				2	6.4			ML - SANDY SILT, YELLOWISH RED, MOIST.
PT	24	91/ 266	JAR-4	7.7 - 9.0	0	53	47					6.0			- SILTY SAND, YELLOWISH RED, MOIST.
PT	24	91/ 267	JAR-5	9.0 - 10.5	0	34	66	26	12	14		8.4			CL - SANDY LEAN CLAY, YELLOWISH RED, MOIST, CALCAREOUS, SAND LENSES, FEW BLACK NODULES.
PT	25	91/ 268	JAR-1	0.0 - 2.4	0	34	66					17.5			- SANDY LEAN CLAY, REDDISH BROWN, MOIST.
PT	25	91/ 269	JAR-2	2.4 - 6.0	0	30	70				2	8.3			ML - SANDY SILT, REDDISH BROWN, MOIST, FEW BLACK NODULES.
PT	25	91/ 270	JAR-3	6.0 - 6.9	0	49	51					8.1			- SANDY LEAN CLAY, REDDISH BROWN AND YELLOWISH RED, MOIST, FEW BLACK NODULES.
PT	25	91/ 271	JAR-4	6.9 - 9.4	2	46	52	26	11	15		9.0			CL - SANDY LEAN CLAY, GRAYISH BROWN, MOIST, CALCAREOUS, BLACK NODULES.
PT	25	91/ 272	JAR-5	9.4 - 10.6	1	51	48				0	9.6			SM - SILTY SAND, YELLOWISH BROWN, MOIST, FEW SPECKS OF WHITE CALCAREOUS MATERIAL.
PT	26	91/ 273	JAR-1	0.0 - 2.7	0	42	58				1	15.9			ML - SANDY SILT, BROWN AND REDDISH BROWN, MOIST, FINE SAND.
PT	26	91/ 274	JAR-2	2.7 - 7.0	1	22	77					17.9			- FAT CLAY WITH SAND, REDDISH BROWN, MOIST, CALCAREOUS, SOME CALCAREOUS PARTICLES THROUGHOUT.
PT	26	91/ 275	JAR-3	7.0 - 7.9	2	19	79	51	19	32		17.0			- SHALE, GRAYISH BROWN MOTTLED WITH RED AND OLIVE YELLOW, MOIST, SLIGHTLY CALCAREOUS, BLOCKY, SOME FINE SAND.
PT	26	91/ 276	JAR-4	7.9 - 9.6	0	17	83					15.5			- SHALE, RED MOTTLED WITH GRAY AND OLIVE YELLOW, MOIST, FEW CALCAREOUS PARTICLES.
PT	26	91/ 277	JAR-5	9.6 - 10.6	0	3	97	35	16	19		10.0			- SHALE, RED AND GRAYISH GREEN, MOIST.
PT	27	91/ 278	JAR-1	0.0 - 2.2	0	53	47					13.5			- SILTY SAND, DARK BROWN, MOIST, ROOTS, FINE SAND.
PT	27	91/ 279	JAR-2	2.2 - 3.6	0	64	36				0	10.8			SM - SILTY SAND, BROWN, TO REDDISH BROWN, MOIST, FINE SAND.
PT	27	91/ 280	JAR-3	3.6 - 5.2	0	66	34				0	2.7			SM - SILTY SAND, LIGHT BROWN, DRY, FINE SAND.
PT	27	91/ 281	JAR-4	5.2 - 7.5	0	49	51	24	13	11		8.1			CL - SANDY LEAN CLAY, GRAYISH BROWN MOTTLED WITH BROWNISH YELLOW, DAMP, FINE SAND.
PT	27	91/ 282	JAR-5	7.5 - 10.2	0	46	54					14.7			- SANDY LEAN CLAY, REDDISH YELLOWISH MOTTLED WITH GRAY, MOIST, FINE SAND.
PT	27	91/ 283	JAR-6	10.2 - 11.8	0	35	65	40	13	27		16.3			CL - SANDY LEAN CLAY, GRAY MOTTLED WITH BROWNISH YELLOW, MOIST, BLACK IRON STAINING, FINE SAND.
PT	4	91/ 284	BAGS1-3	1.9 - 5.0	0	44	56	27	16	11				COMPACTION AND TRIAX-Q, TRIAX-R, DS	CL - SANDY LEAN CLAY, REDDISH BROWN.
COMBINED BAG 1, 2 AND 3 FROM BORING PT-4															
PT	20	91/ 286	BAGS1-3	3.0 - 5.0	0	64	36				2			COMPACTION AND	SM - SILTY SAND, YELLOWISH BROWN.

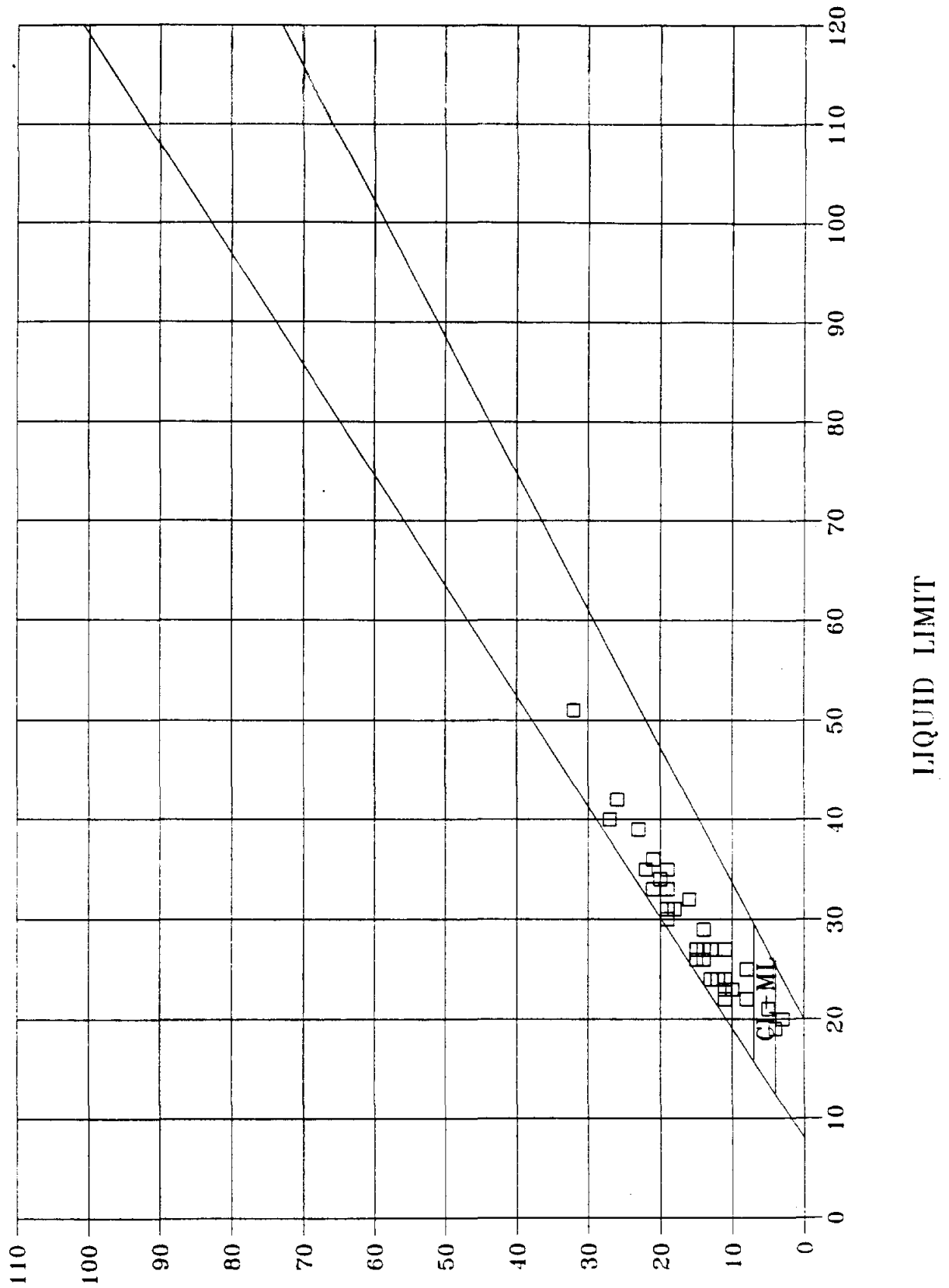

PLASTIC INDEX

LIQUID LIMIT

PLUM CREEK  
BORROW AREA  
PLASTICITY CHART  
PLATE #

DEPARTMENT OF THE ARMY, SOUTHWESTERN DIVISION LABORATORY  
 CORPS OF ENGINEERS, 4815 CASS STREET, DALLAS, TX 75235

WORK ORDER NO.  
 Req. No.  
 Contract No.

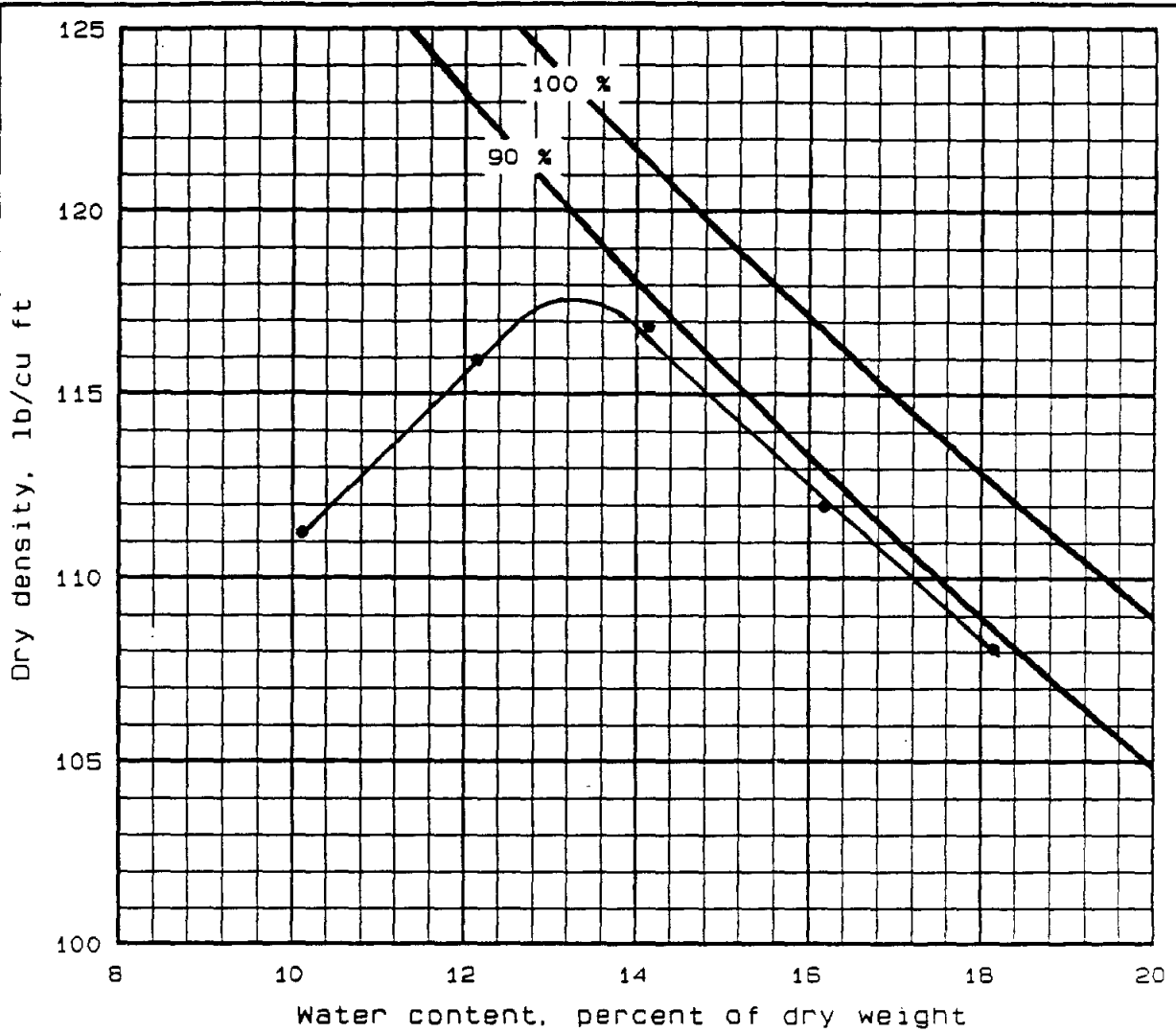

Standard compaction test ASTM D698 Method A  
 25 blows per each of 3 layers, with 5.50 lb. sleeve rammer  
 and 12.0 inch drop. 4.0 inch diameter mold

Sample No.	Elev/Depth	Classification	G	LL	PL	% > No. 4	% > 3/4 in
286	3.0 -	SILTY SAND (SM)	2.68			0	0
	5.0						

Sample No.	286		
Water content, percent	2.2	AIR DRY MOISTURE	
Optimum water content, percent	13.2		
Max dry density, lb/cu ft	117.6		

Remarks:	Project: PLUM CREEK - BORROW AREA	
	CESWD-ED-GL REPORT NO. 15299	
	Lab No.: 90/286	
	Area: BAGS 1-3	
	Boring No.: PC-20	Date: MARCH 1991

**COMPACTION TEST REPORT**

WORK ORDER NO.  
Req. No.  
Contract No.

DEPARTMENT OF THE ARMY, SOUTHWESTERN DIVISION LABORATORY  
CORPS OF ENGINEERS, 4815 CASS STREET, DALLAS, TX 75235

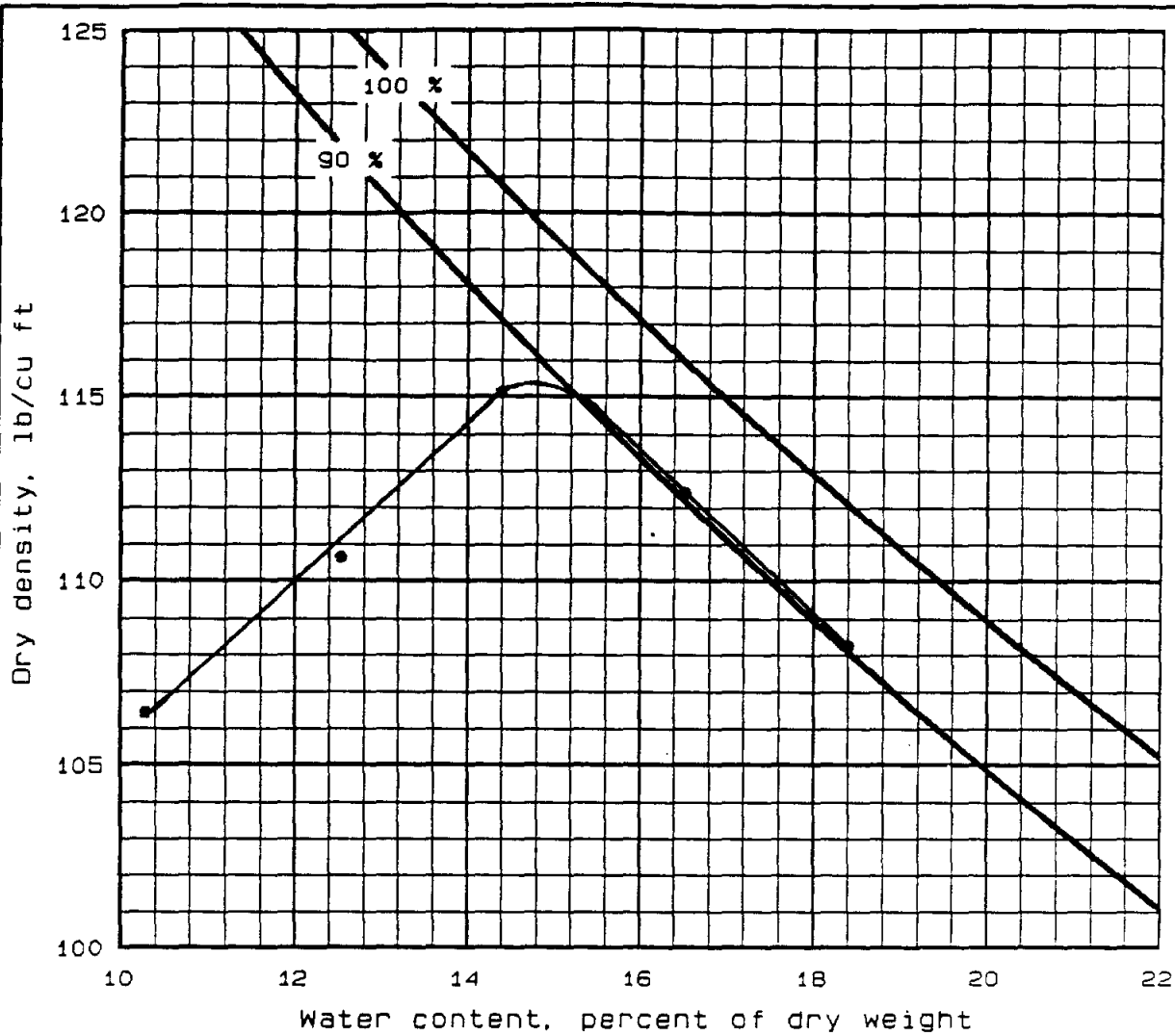

Standard compaction test ASTM D698 Method A  
25 blows per each of 3 layers, with 5.50 lb. sleeve rammer  
and 12.0 inch drop. 4.0 inch diameter mold

Sample No.	Elev/Depth	Classification	G	LL	PL	% > No. 4	% > 3/4 in
284	1.9 -	SANDY LEAN CLAY (CL)	2.68	27	16	0	0
	5.0						

Sample No.	284		
Water content, percent	2.5	AIR DRY MOISTURE	
Optimum water content, percent	14.8		
Max dry density, lb/cu ft	115.4		

Remarks:	Project: PLUM CREEK - BORROW AREA	
	CESWD-ED-GL REPORT NO. 15299	
	Lab No.: 90/284	
	Area: BAGS 1-3	
	Boring No.: PC-4	Date: MARCH 1991

**COMPACTION TEST REPORT**

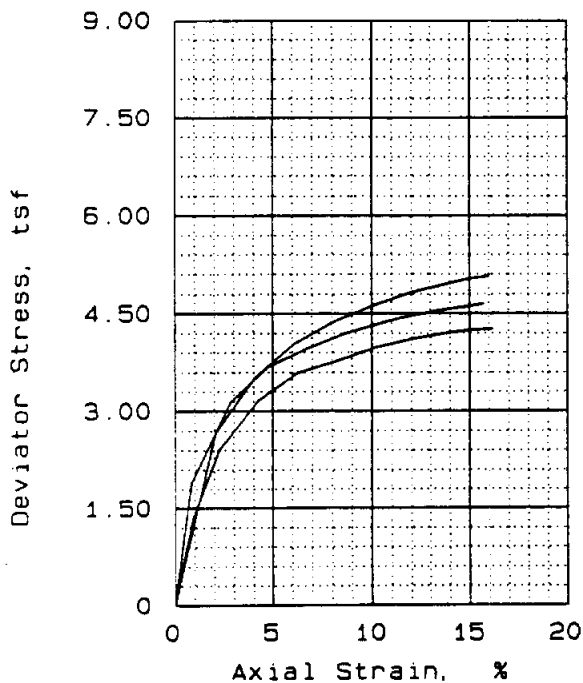
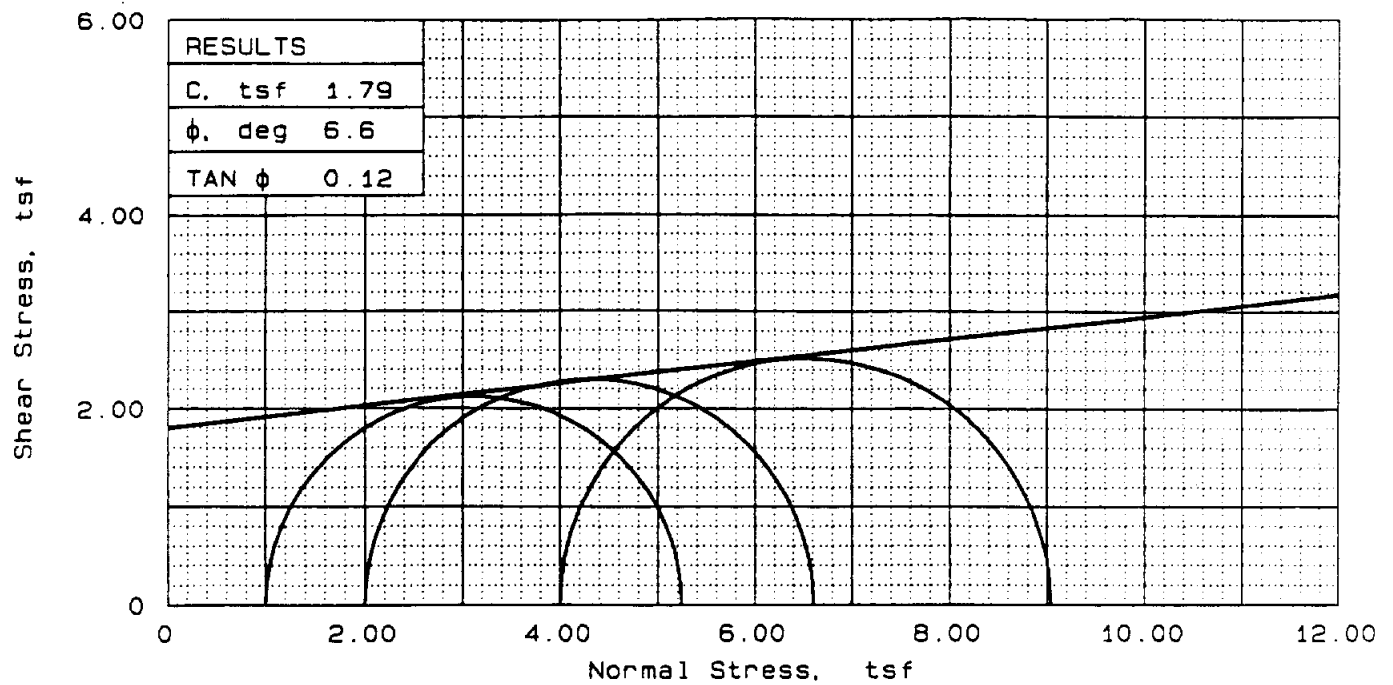

SAMPLE NO.		1	2	3
INITIAL	WATER CONTENT, %	15.1	15.1	15.0
	DRY DENSITY, pcf	115.7	115.3	116.0
	SATURATION, %	90.7	89.6	91.0
	VOID RATIO	0.445	0.451	0.443
	DIAMETER, in	1.41	1.41	1.41
	HEIGHT, in	3.03	3.03	3.02
AT TEST	WATER CONTENT, %	15.1	15.1	15.0
	DRY DENSITY, pcf	115.7	115.3	116.0
	SATURATION, %	90.7	89.6	91.0
	VOID RATIO	0.445	0.451	0.443
	DIAMETER, in	1.41	1.41	1.41
	HEIGHT, in	3.03	3.03	3.02
BACK PRESSURE, tsf		0.00	0.00	0.00
CELL PRESSURE, tsf		1.00	2.00	4.00
FAILURE STRESS, tsf		4.24	4.60	5.04
PORE PRESSURE, tsf				
STRAIN RATE, %/min.		0.900	0.900	0.900
ULTIMATE STRESS, tsf				
PORE PRESSURE, tsf				
$\sigma_1$ FAILURE, tsf		5.24	6.61	9.04
$\sigma_3$ FAILURE, tsf		1	2	4

TYPE OF TEST:  
 Unconsolidated undrained  
 SAMPLE TYPE: REMOLDED  
 DESCRIPTION: SANDY LEAN CLAY  
 (CL)  
 LL = 27      PL = 16      PI = 11.0  
 SPECIFIC GRAVITY = 2.68  
 REMARKS: SPECIMENS REMOLDED TO  
 MAXIMUM DRY DENSITY AT  
 OPTIMUM WATER CONTENT

CLIENT: US ARMY CORPS OF ENGINEERS  
 TULSA DISTRICT  
 PROJECT: PLUM CREEK - BORROW AREA TESTING  
 SAMPLE LOCATION: BORING: TP-4, 1.9'-5.0',  
 BAGS 1, 2 AND 3, SWD NO. 91/284  
 PROJ. NO.: 15299      DATE: 10 MAY 1991

TRIAxIAL COMPRESSION TEST

CORPS OF ENGINEERS - SOUTHWESTERN

FIG. NO.

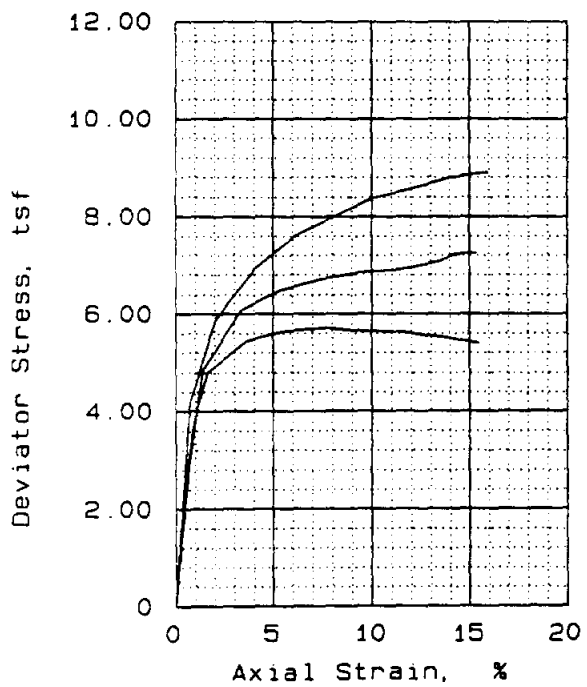
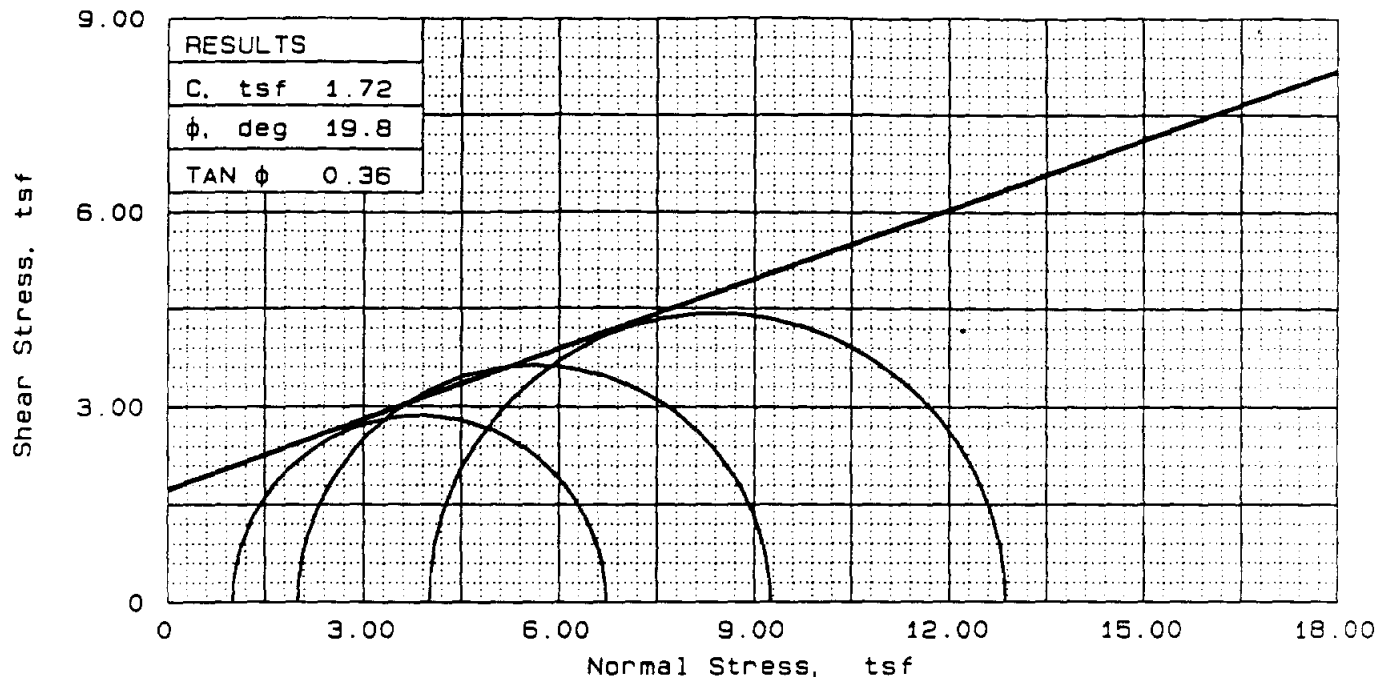

SAMPLE NO.		1	2	3
INITIAL	WATER CONTENT, %	12.9	12.8	12.6
	DRY DENSITY, pcf	114.8	115.1	114.4
	SATURATION, %	75.5	75.8	72.8
	VOID RATIO	0.457	0.454	0.463
	DIAMETER, in	1.41	1.41	1.41
	HEIGHT, in	3.04	3.01	3.03
AT TEST	WATER CONTENT, %	12.9	12.8	12.6
	DRY DENSITY, pcf	114.8	115.1	114.4
	SATURATION, %	75.5	75.8	72.8
	VOID RATIO	0.457	0.454	0.463
	DIAMETER, in	1.41	1.41	1.41
	HEIGHT, in	3.04	3.01	3.03
BACK PRESSURE, tsf		0.00	0.00	0.00
CELL PRESSURE, tsf		1.00	2.00	4.00
FAILURE STRESS, tsf		5.72	7.25	8.86
PORE PRESSURE, tsf				
STRAIN RATE, %/min.		0.900	0.900	0.900
ULTIMATE STRESS, tsf				
PORE PRESSURE, tsf				
$\sigma_1$ FAILURE, tsf		6.72	9.25	12.86
$\sigma_3$ FAILURE, tsf		1	2	4

TYPE OF TEST:  
Unconsolidated undrained

SAMPLE TYPE: REMOLDED

DESCRIPTION: SAND LEAN CLAY (CL)

LL= 27      PL= 16      PI= 11.0

SPECIFIC GRAVITY= 2.68

REMARKS: SPECIMEN REMOLDED TO MAXIMUM DRY DENSITY AT OPTIMUM -2% WATER CONTENT

CLIENT: US ARMY CORPS OF ENGINEERS  
TULSA DISTRICT

PROJECT: PLUM CREEK - BORROW AREA TESTING

SAMPLE LOCATION: BORING: TP-4, 1.9'-5.0',  
BAGS 1, 2 AND 3, SWD NO. 91/284

PROJ. NO.: 15299      DATE: 10 MAY 1991

TRIAxIAL COMPRESSION TEST

**CORPS OF ENGINEERS - SOUTHWESTERN**

FIG. NO.



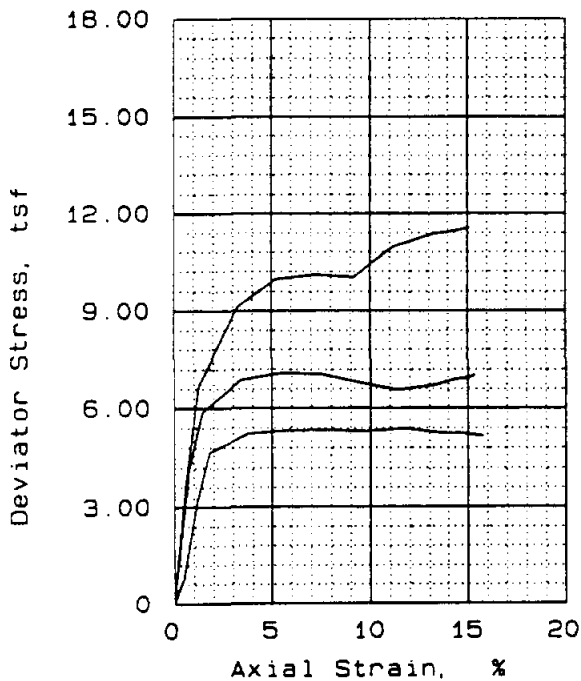
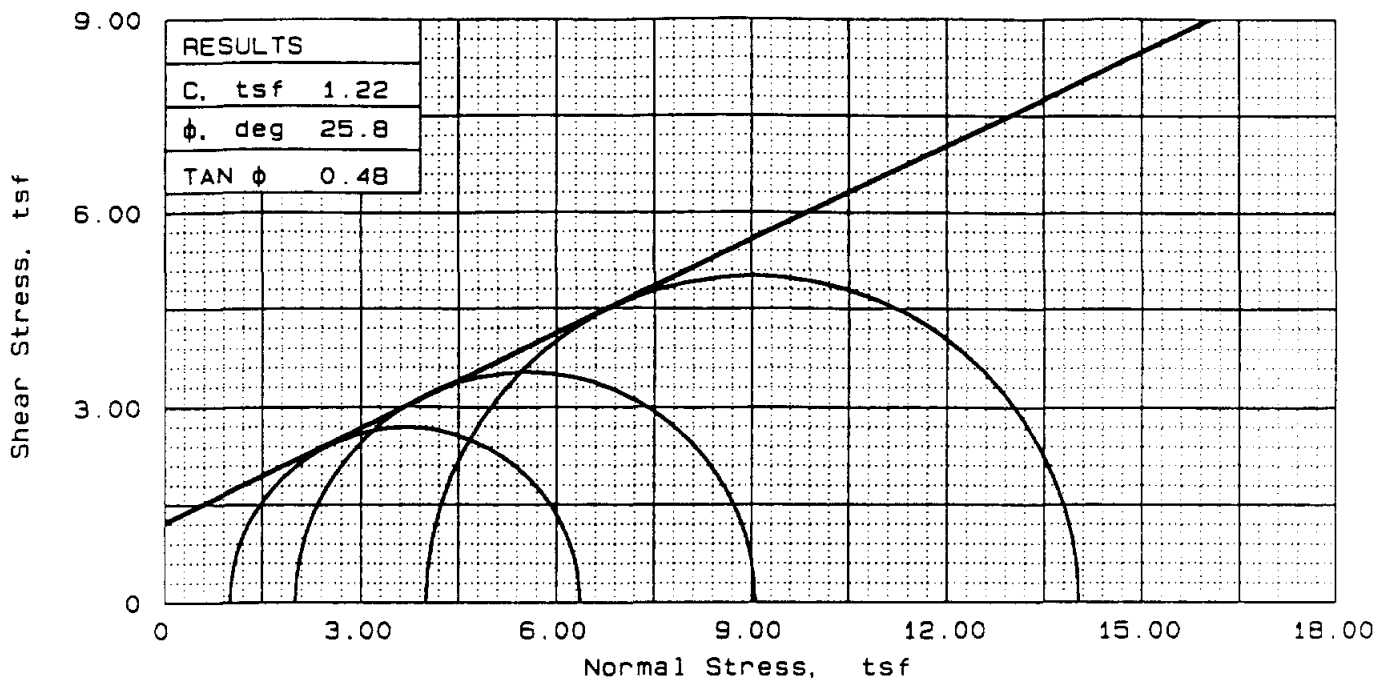

SAMPLE NO.		1	2	3
INITIAL	WATER CONTENT, %	11.3	11.4	11.2
	DRY DENSITY, pcf	115.8	117.8	118.6
	SATURATION, %	68.2	72.7	73.3
	VOID RATIO	0.445	0.420	0.411
	DIAMETER, in	1.41	1.41	1.41
	HEIGHT, in	3.02	3.02	3.04
AT TEST	WATER CONTENT, %	11.3	11.4	11.2
	DRY DENSITY, pcf	115.8	117.8	118.6
	SATURATION, %	68.2	72.7	73.3
	VOID RATIO	0.445	0.420	0.411
	DIAMETER, in	1.41	1.41	1.41
	HEIGHT, in	3.02	3.02	3.04
BACK PRESSURE, tsf	0.00	0.00	0.00	
CELL PRESSURE, tsf	1.00	2.00	4.00	
FAILURE STRESS, tsf	5.37	7.06	10.03	
PORE PRESSURE, tsf				
STRAIN RATE, %/min.	0.900	0.900	0.900	
ULTIMATE STRESS, tsf				
PORE PRESSURE, tsf				
$\sigma_1$ FAILURE, tsf	6.37	9.06	14.04	
$\sigma_3$ FAILURE, tsf	1	2	4	

TYPE OF TEST:  
Unconsolidated undrained

SAMPLE TYPE:  
DESCRIPTION: SILTY SAND (SM)

LL= NP      PL= NP      PI=

SPECIFIC GRAVITY= 2.68

REMARKS: SPECIMENS REMOLDED TO  
MAXIMUM DRY DENSITY AT  
OPTIMUM -2% WATER CONTENT

CLIENT: US ARMY CORPS OF ENGINEERS  
TULSA DISTRICT  
PROJECT: PLUM CREEK - BORROW AREA TESTING

SAMPLE LOCATION: BORING: TP-20, 3.0'-5.0',  
BAGS 1, 2 AND 3, SWD NO. 91/286

PROJ. NO.: 15299      DATE: 10 MAY 1991

TRIAxIAL COMPRESSION TEST

CORPS OF ENGINEERS - SOUTHWESTERN

FIG. NO.

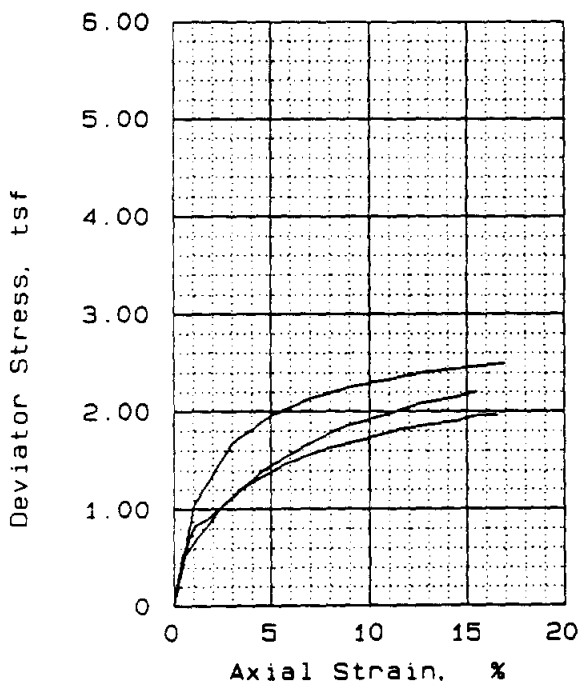
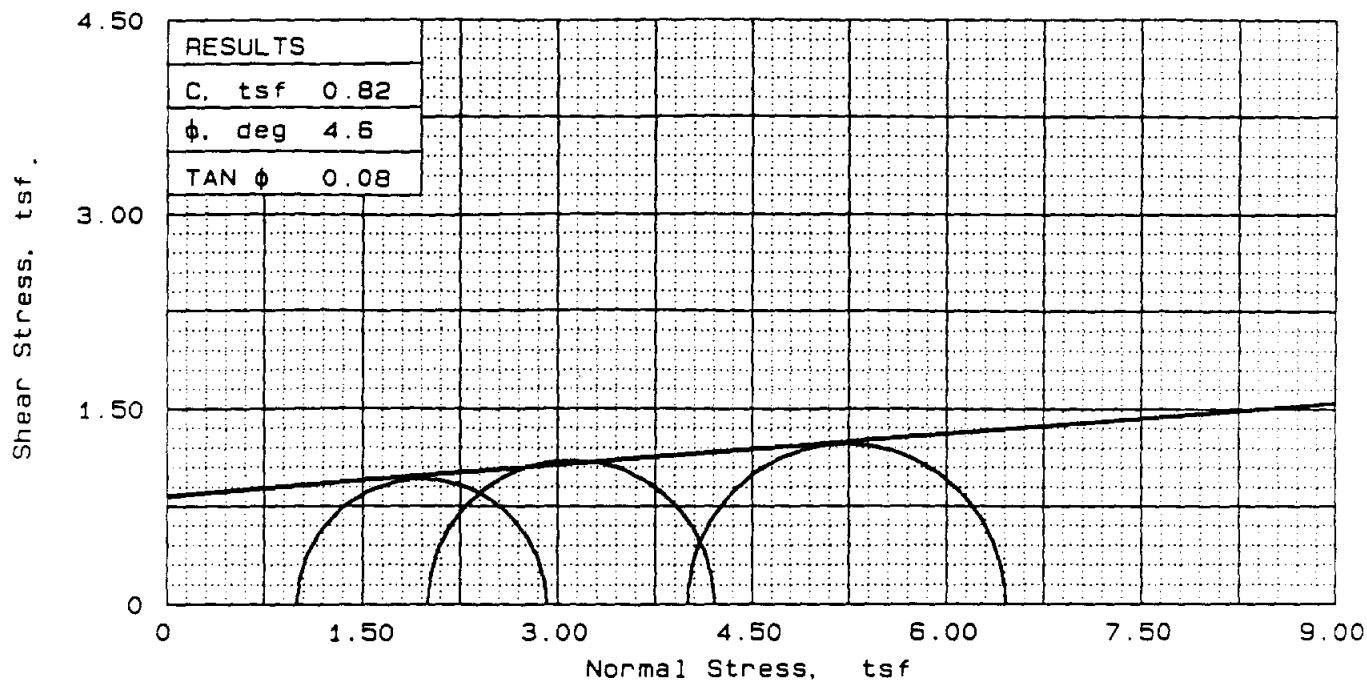

SAMPLE NO.		1	2	3
INITIAL	WATER CONTENT, %	17.0	16.9	16.7
	DRY DENSITY, pcf	110.7	111.0	111.6
	SATURATION, %	89.1	89.4	89.9
	VOID RATIO	0.512	0.507	0.499
	DIAMETER, in	1.41	1.42	1.41
	HEIGHT, in	3.04	3.03	3.02
AT TEST	WATER CONTENT, %	17.0	16.9	16.7
	DRY DENSITY, pcf	110.7	111.0	111.6
	SATURATION, %	89.1	89.4	89.9
	VOID RATIO	0.512	0.507	0.499
	DIAMETER, in	1.41	1.42	1.41
	HEIGHT, in	3.04	3.03	3.02
BACK PRESSURE, tsf		0.00	0.00	0.00
CELL PRESSURE, tsf		1.00	2.00	4.00
FAILURE STRESS, tsf		1.91	2.20	2.45
PORE PRESSURE, tsf				
STRAIN RATE, %/min.		0.900	0.900	0.900
ULTIMATE STRESS, tsf				
PORE PRESSURE, tsf				
$\sigma_1$ FAILURE, tsf		2.91	4.21	6.46
$\sigma_3$ FAILURE, tsf		1	2	4

TYPE OF TEST:  
Unconsolidated undrained

SAMPLE TYPE: REMOLDED

DESCRIPTION: SANDY LEAN CLAY (CL)

LL = 27      PL = 16      PI = 11.0

SPECIFIC GRAVITY = 2.68

REMARKS: SPECIMENS REMOLDED TO MAXIMUM DENSITY AT OPTIMUM +2% WATER CONTENT

CLIENT: US ARMY CORPS OF ENGINEERS  
TULSA DISTRICT

PROJECT: PLUM CREEK - BORROW AREA TESTING

SAMPLE LOCATION: BORING: TP-4, 1.9'-5.0',  
BAGS 1, 2 AND 3, SWD NO. 91/284

PROJ. NO.: 15299      DATE: 10 MAY 1991

TRIAxIAL COMPRESSION TEST

CORPS OF ENGINEERS - SOUTHWESTERN

FIG. NO.

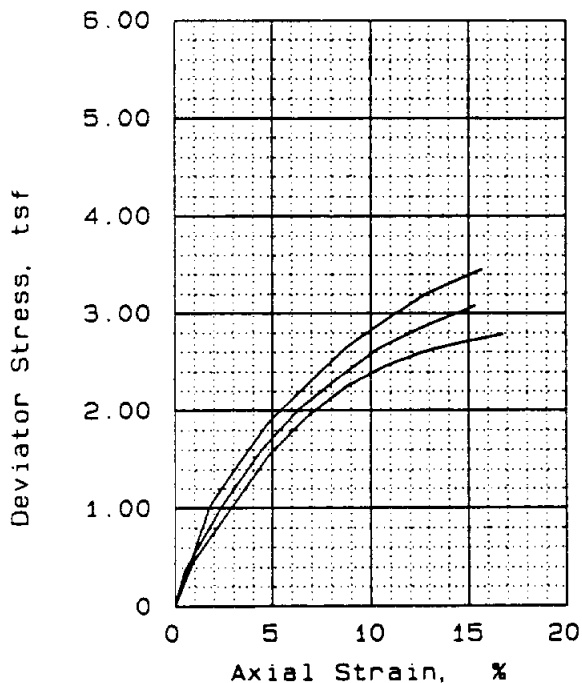
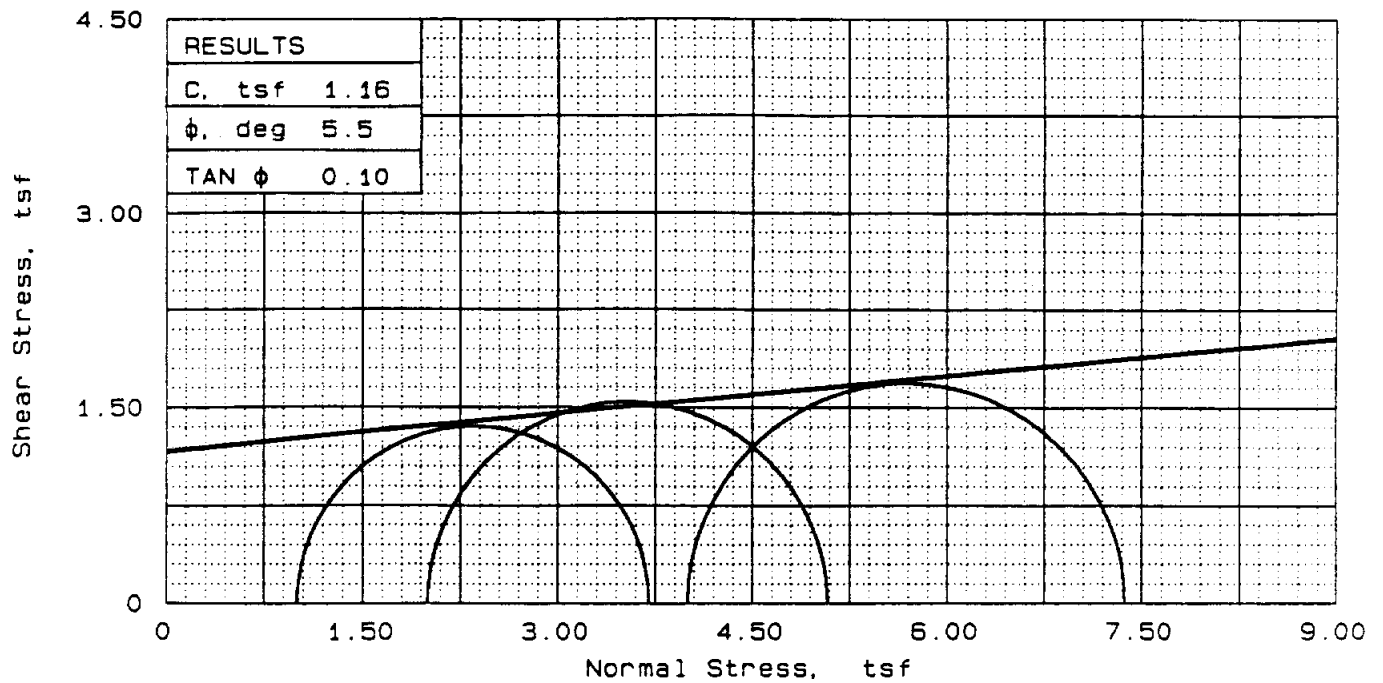

SAMPLE NO.		1	2	3
INITIAL	WATER CONTENT, %	15.2	15.3	15.2
	DRY DENSITY, pcf	113.6	113.4	113.1
	SATURATION, %	86.0	86.4	85.2
	VOID RATIO	0.473	0.475	0.480
	DIAMETER, in	1.41	1.41	1.42
	HEIGHT, in	3.04	3.04	3.03
AT TEST	WATER CONTENT, %	15.2	15.3	15.2
	DRY DENSITY, pcf	113.6	113.4	113.1
	SATURATION, %	86.0	86.4	85.2
	VOID RATIO	0.473	0.475	0.480
	DIAMETER, in	1.41	1.41	1.42
	HEIGHT, in	3.04	3.04	3.03
BACK PRESSURE, tsf		0.00	0.00	0.00
CELL PRESSURE, tsf		1.00	2.00	4.00
FAILURE STRESS, tsf		2.70	3.08	3.37
PORE PRESSURE, tsf				
STRAIN RATE, %/min.		0.900	0.900	0.900
ULTIMATE STRESS, tsf				
PORE PRESSURE, tsf				
$\sigma_1$ FAILURE, tsf		3.70	5.08	7.37
$\sigma_3$ FAILURE, tsf		1	2	4

TYPE OF TEST:  
Unconsolidated undrained  
SAMPLE TYPE: REMOLDED  
DESCRIPTION: SILTY SAND (SM)

LL= NP      PL= NP      PI=  
SPECIFIC GRAVITY= 2.68  
REMARKS: SPECIMENS REMOLDED TO  
MAXIMUM DRY DENSITY AT  
OPTIMUM +2% WATER CONTENT

FIG. NO.

CLIENT: US ARMY CORPS OF ENGINEERS  
TULSA DISTRICT  
PROJECT: PLUM CREEK - BORROW AREA TESTING  
SAMPLE LOCATION: BORING: 20, 3.0'-5.0',  
BAGS 1, 2 AND 3, SWD NO. 91/286  
PROJ. NO.: 15299      DATE: 10 MAY 1991

TRIAxIAL COMPRESSION TEST  
CORPS OF ENGINEERS - SOUTHWESTERN

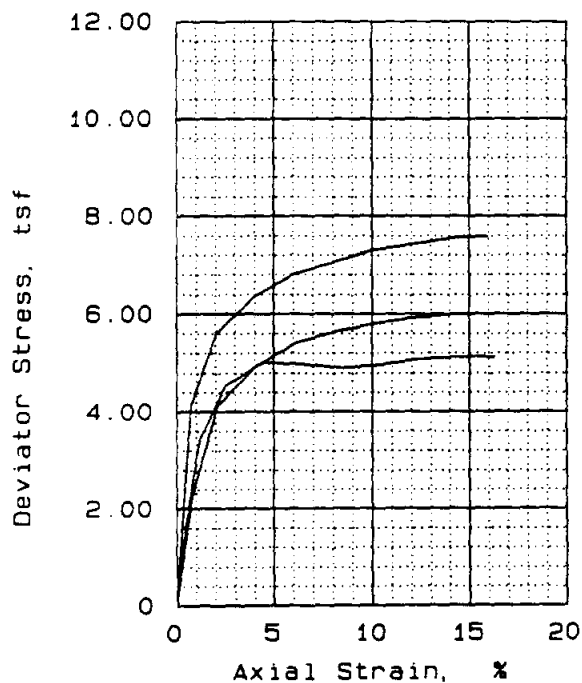
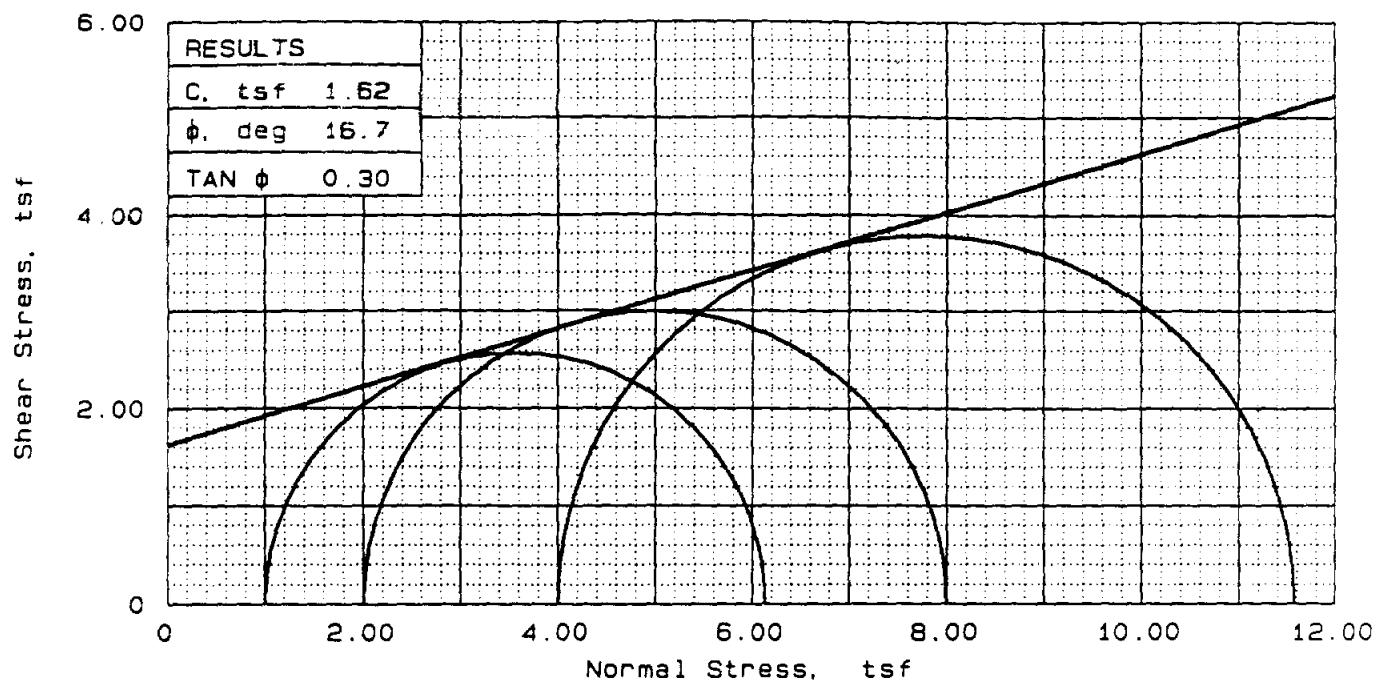

SAMPLE NO.		1	2	3
INITIAL	WATER CONTENT, %	13.3	13.4	13.3
	DRY DENSITY, pcf	118.4	116.9	115.7
	SATURATION, %	88.9	85.6	82.3
	VOID RATIO	0.397	0.415	0.430
	DIAMETER, in	1.41	1.41	1.41
	HEIGHT, in	3.04	3.02	3.02
AT TEST	WATER CONTENT, %	13.3	13.4	13.3
	DRY DENSITY, pcf	118.4	116.9	115.7
	SATURATION, %	88.9	85.6	82.3
	VOID RATIO	0.397	0.415	0.430
	DIAMETER, in	1.41	1.41	1.41
	HEIGHT, in	3.04	3.02	3.02
BACK PRESSURE, tsf	0.00	0.00	0.00	
CELL PRESSURE, tsf	1.00	2.00	4.00	
FAILURE STRESS, tsf	5.14	5.99	7.57	
PORE PRESSURE, tsf				
STRAIN RATE, %/min.	0.900	0.900	0.900	
ULTIMATE STRESS, tsf				
PORE PRESSURE, tsf				
$\sigma_1$ FAILURE, tsf	6.14	7.99	11.58	
$\sigma_3$ FAILURE, tsf	1	2	4	

TYPE OF TEST:  
Unconsolidated undrained

SAMPLE TYPE: REMOLDED

DESCRIPTION: SILTY SAND (SM)

LL= NP      PL= NP      PI=

SPECIFIC GRAVITY= 2.68

REMARKS: SPECIMENS REMOLDED TO  
MAXIMUM DRY DENSITY AT  
OPTIMUM WATER CONTENT

CLIENT: US ARMY CORPS OF ENGINEERS  
TULSA DISTRICT

PROJECT: PLUM CREEK - BORROW AREA TESTING

SAMPLE LOCATION: BORING: TP-20, 3.0'-5.0',  
BAGS 1, 2 AND 3, SWD NO. 91/286

PROJ. NO.: 15299      DATE: 08 MAY 1991

TRIAxIAL COMPRESSION TEST

CORPS OF ENGINEERS - SOUTHWESTERN

FIG. NO.

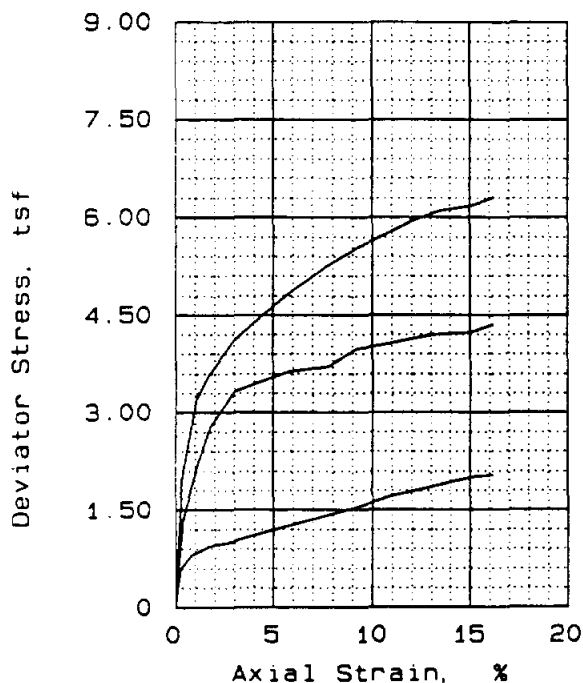
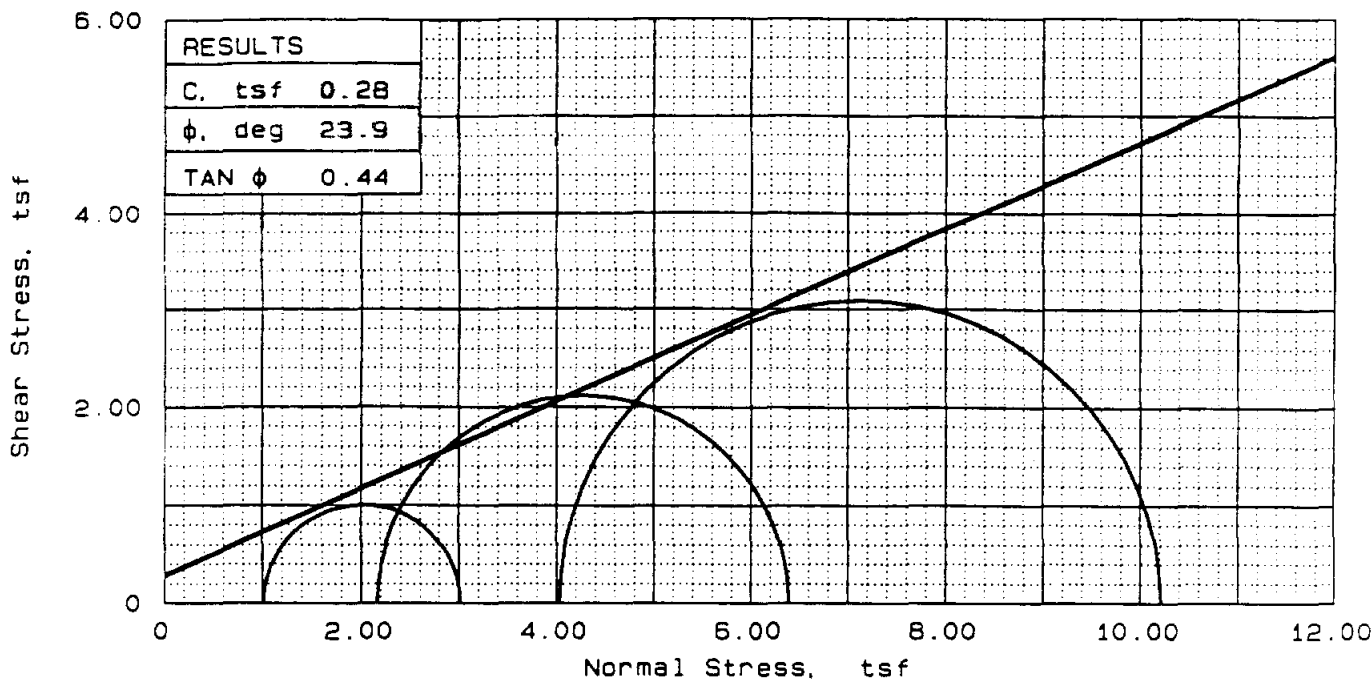

SAMPLE NO.		1	2	3
INITIAL	WATER CONTENT, %	15.0	15.5	15.4
	DRY DENSITY, pcf	113.9	114.8	115.6
	SATURATION, %	85.9	90.9	91.9
	VOID RATIO	0.469	0.457	0.447
	DIAMETER, in	1.41	1.41	1.41
	HEIGHT, in	3.02	3.02	3.04
AT TEST	WATER CONTENT, %	16.7	15.9	14.8
	DRY DENSITY, pcf	115.5	117.2	119.8
	SATURATION, %	100.0	100.0	100.0
	VOID RATIO	0.448	0.427	0.397
	DIAMETER, in	1.41	1.41	1.40
	HEIGHT, in	2.99	3.00	2.97
BACK PRESSURE, tsf		7.20	5.18	5.98
CELL PRESSURE, tsf		8.21	7.34	10.01
FAILURE STRESS, tsf		2.00	4.23	6.18
PORE PRESSURE, tsf				
STRAIN RATE, %/min.		0.001	0.001	0.001
ULTIMATE STRESS, tsf				
PORE PRESSURE, tsf				
$\sigma_1$ FAILURE, tsf		3.01	6.39	10.21
$\sigma_3$ FAILURE, tsf		1.01	2.16	4.03

TYPE OF TEST: Consolidated undrained  
 SAMPLE TYPE: REMOLDED  
 DESCRIPTION: SANDY LEAN CLAY (CL)  
 LL= 27      PL= 16      PI= 11.0  
 SPECIFIC GRAVITY= 2.68  
 REMARKS: SPECIMENS REMOLDED TO MAXIMUM DRY DENSITY AT OPTIMUM WATER CONTENT

CLIENT: US ARMY CORPS OF ENGINEERS  
 TULSA DISTRICT  
 PROJECT: PLUM CREEK - BORROW AREA TESTING  
 SAMPLE LOCATION: BORING: TP-4, 3.0'-5.0', BAGS 1, 2 AND 3, SWD NO. 91/284  
 PROJ. NO.: 15299      DATE: 13 MAY 1991

TRIAxIAL COMPRESSION TEST

CORPS OF ENGINEERS - SOUTHWESTERN

FIG. NO.

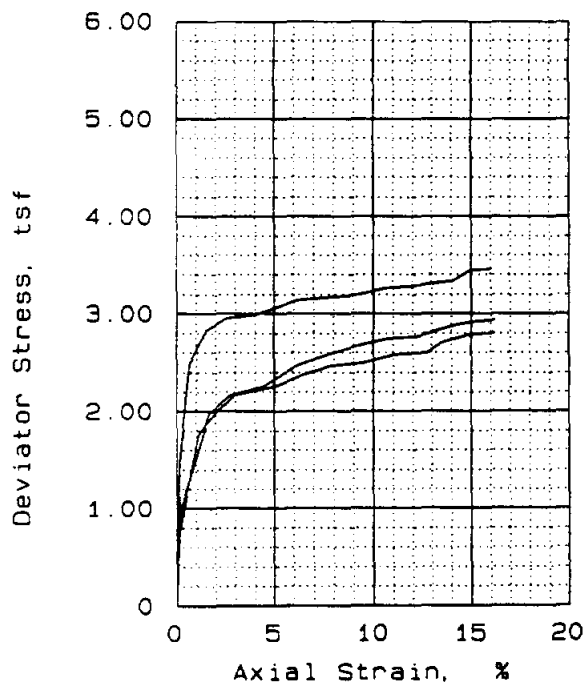
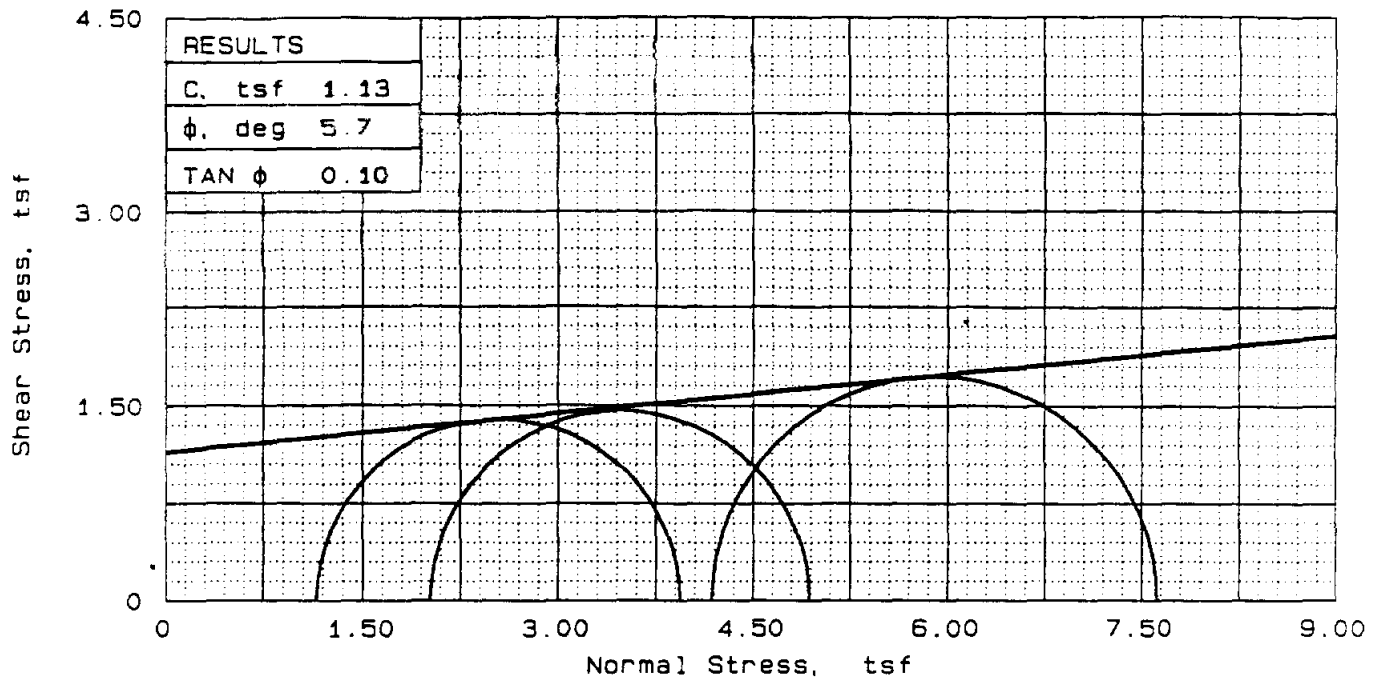

SAMPLE NO.		1	2	3
INITIAL	WATER CONTENT, %	13.2	12.7	13.2
	DRY DENSITY, pcf	115.4	115.3	113.4
	SATURATION, %	78.6	75.8	74.4
	VOID RATIO	0.450	0.451	0.476
	DIAMETER, in	1.41	1.42	1.42
	HEIGHT, in	3.03	3.02	3.02
AT TEST	WATER CONTENT, %	17.5	16.4	16.4
	DRY DENSITY, pcf	113.9	116.2	116.2
	SATURATION, %	100.0	100.0	100.0
	VOID RATIO	0.469	0.439	0.439
	DIAMETER, in	1.43	1.42	1.40
	HEIGHT, in	3.02	2.99	3.02
BACK PRESSURE, tsf		7.70	7.06	7.20
CELL PRESSURE, tsf		8.86	9.07	11.38
FAILURE STRESS, tsf		2.79	2.92	3.44
PORE PRESSURE, tsf				
STRAIN RATE, %/min.		0.001	0.001	0.001
ULTIMATE STRESS, tsf				
PORE PRESSURE, tsf				
$\sigma_1$ FAILURE, tsf		3.94	4.93	7.62
$\sigma_3$ FAILURE, tsf		1.15	2.02	4.18

TYPE OF TEST:  
Consolidated undrained

SAMPLE TYPE: REMOLDED

DESCRIPTION: SANDY LEAN CLAY (CL)

LL= 27      PL= 16      PI= 11.0

SPECIFIC GRAVITY= 2.68

REMARKS: SPECIMENS REMOLDED TO MAXIMUM DRY DENSITY AT OPTIMUM -2% WATER CONTENT

CLIENT: US ARMY CORPS OF ENGINEERS  
TULSA DISTRICT

PROJECT: PLUM CREEK - BORROW AREA TESTING

SAMPLE LOCATION: BORING: TP-4, 3.0'-5.0',  
BAGS 1, 2 AND 3, SWD NO. 91284

PROJ. NO.: 15299      DATE: 13 MAY 1991

TRIAxIAL COMPRESSION TEST

CORPS OF ENGINEERS - SOUTHWESTERN

FIG. NO.

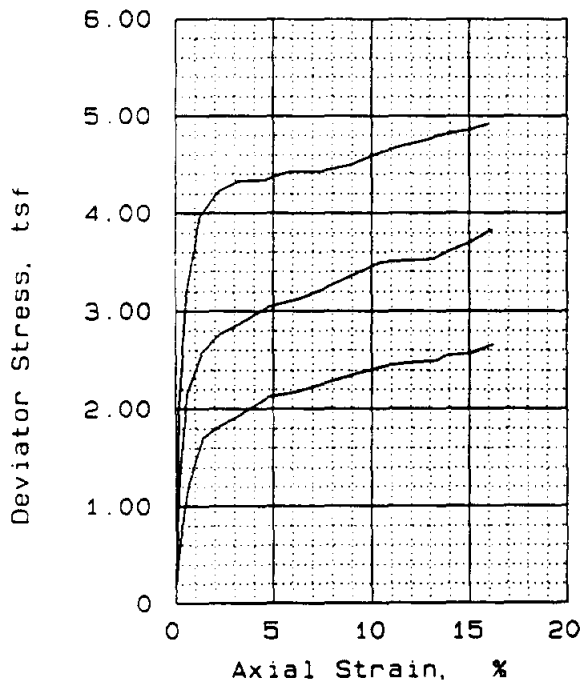
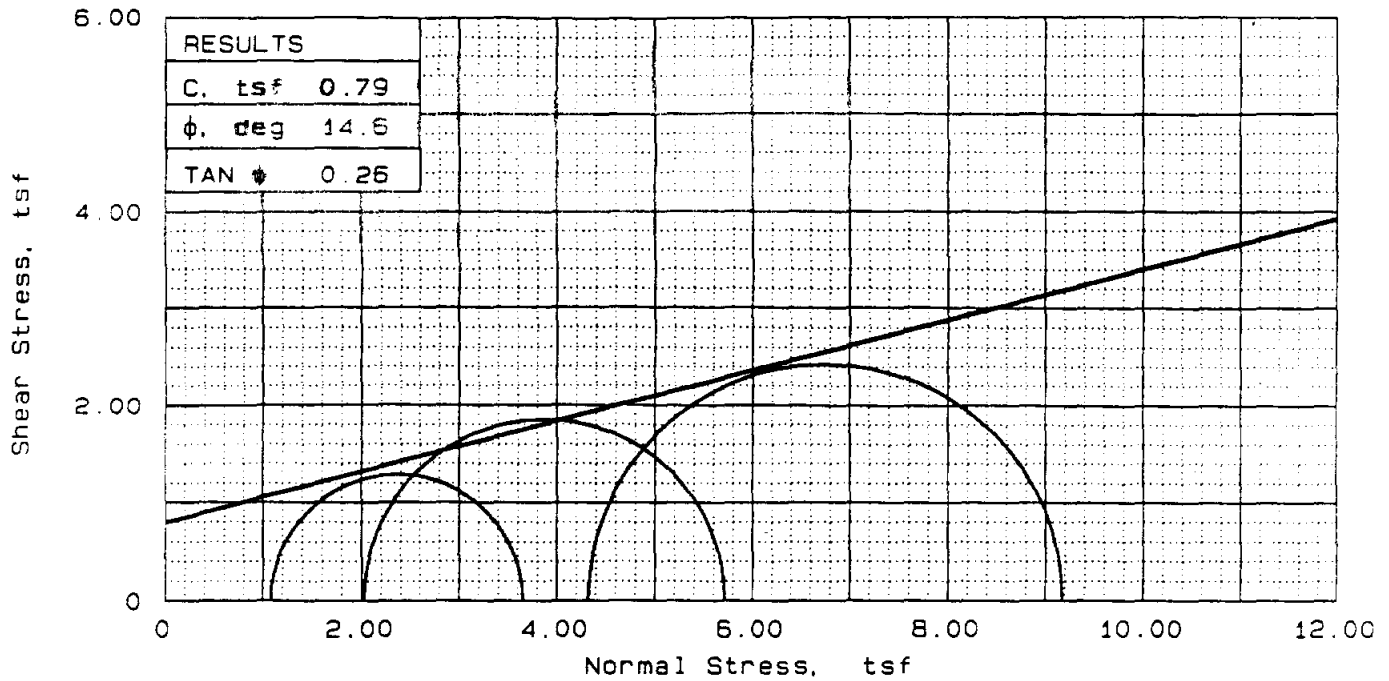

SAMPLE NO.		1	2	3
INITIAL	WATER CONTENT, %	11.9	11.7	11.8
	DRY DENSITY, pcf	115.6	117.4	116.3
	SATURATION, %	71.5	73.8	71.9
	VOID RATIO	0.448	0.426	0.438
	DIAMETER, in	1.42	1.41	1.41
	HEIGHT, in	3.04	3.02	3.02
AT TEST	WATER CONTENT, %	16.7	15.6	15.7
	DRY DENSITY, pcf	115.6	117.9	117.8
	SATURATION, %	100.0	100.0	100.0
	VOID RATIO	0.448	0.419	0.421
	DIAMETER, in	1.43	1.41	1.41
	HEIGHT, in	2.99	3.00	3.02
BACK PRESSURE, tsf		7.92	7.42	7.42
CELL PRESSURE, tsf		9.00	9.43	11.74
FAILURE STRESS, tsf		2.57	3.70	4.85
PORE PRESSURE, tsf				
STRAIN RATE, %/min.		0.001	0.001	0.001
ULTIMATE STRESS, tsf				
PORE PRESSURE, tsf				
$\sigma_1$ FAILURE, tsf		3.65	5.71	9.17
$\sigma_3$ FAILURE, tsf		1.08	2.02	4.32

TYPE OF TEST:  
 Consolidated undrained  
 SAMPLE TYPE: REMOLDED  
 DESCRIPTION: SILTY SAND (SM)

LL = NP      PL = NP      PI =  
 SPECIFIC GRAVITY = 2.68  
 REMARKS: SPECIMENS REMOLDED TO  
 MAXIMUM DRY DENSITY AT  
 OPTIMUM -2% WATER CONTENT

FIG. NO.

CLIENT: US ARMY CORPS OF ENGINEERS  
 TULSA DISTRICT  
 PROJECT: PLUM CREEK - BORROW AREA TESTING  
 SAMPLE LOCATION: BORING: TP-20, 3.0'-5.0',  
 BAGS 1, 2 AND 3, SWD NO. 91/286  
 PROJ. NO.: 15299      DATE: 13 MAY 1991  
 TRIAXIAL COMPRESSION TEST  
**CORPS OF ENGINEERS - SOUTHWESTERN**

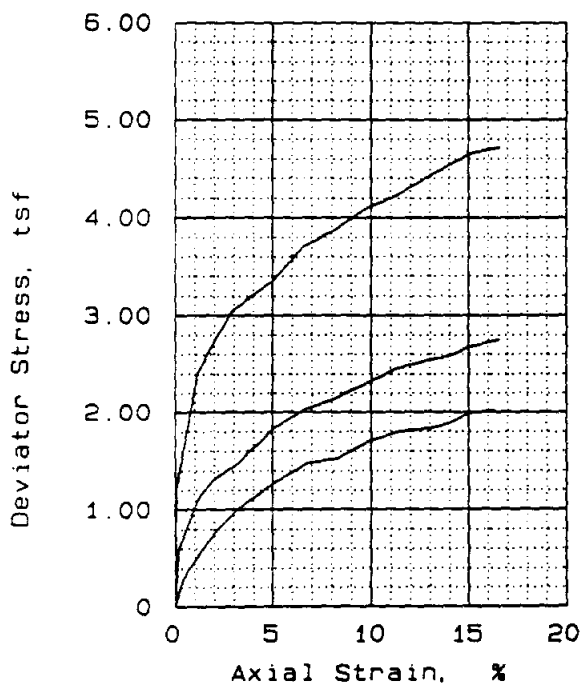
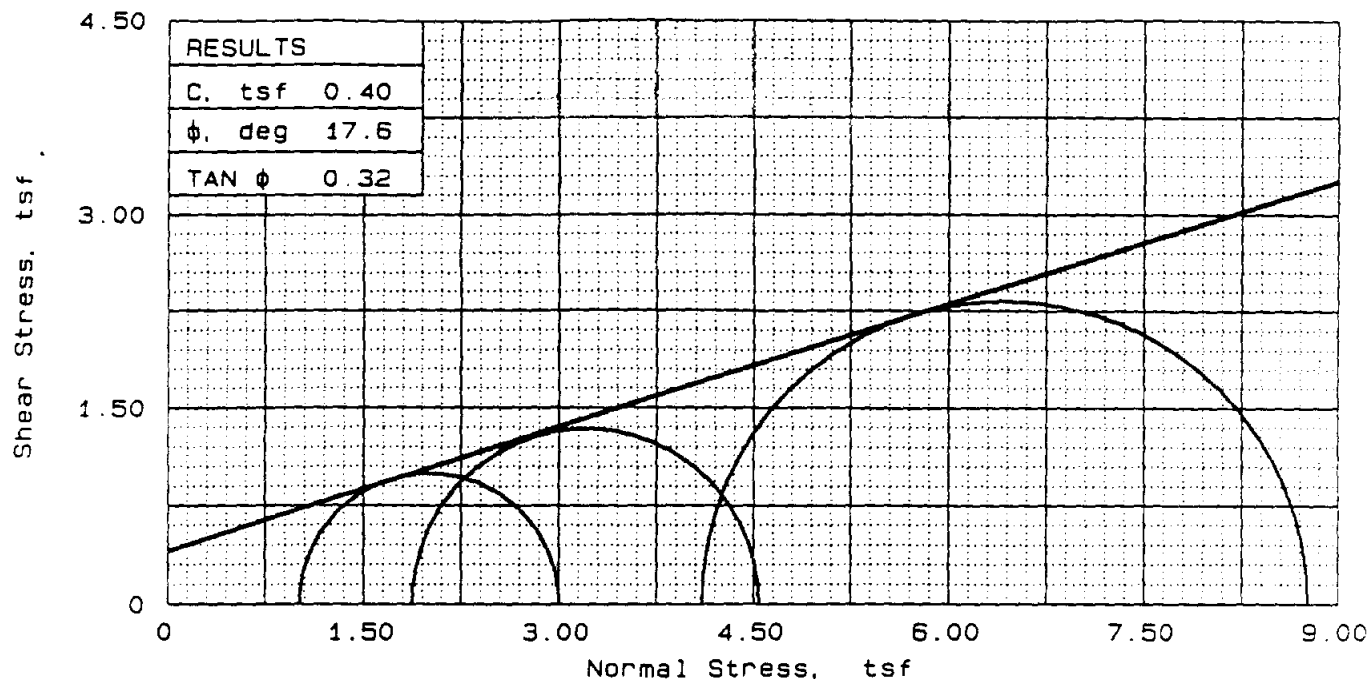

SAMPLE NO.		1	2	3
INITIAL	WATER CONTENT, %	17.4	17.3	17.3
	DRY DENSITY, pcf	110.3	110.5	110.0
	SATURATION, %	90.1	90.3	89.2
	VOID RATIO	0.517	0.514	0.520
	DIAMETER, in	1.41	1.41	1.41
	HEIGHT, in	3.02	3.03	3.02
AT TEST	WATER CONTENT, %	17.5	17.0	15.6
	DRY DENSITY, pcf	113.8	115.0	118.0
	SATURATION, %	100.0	100.0	100.0
	VOID RATIO	0.470	0.455	0.417
	DIAMETER, in	1.39	1.40	1.39
	HEIGHT, in	3.01	2.97	2.91
BACK PRESSURE, tsf		7.20	6.48	5.62
CELL PRESSURE, tsf		8.21	8.35	9.72
FAILURE STRESS, tsf		1.99	2.67	4.66
PORE PRESSURE, tsf				
STRAIN RATE, %/min.		0.001	0.001	0.001
ULTIMATE STRESS, tsf				
PORE PRESSURE, tsf				
$\sigma_1$ FAILURE, tsf		3.00	4.55	8.75
$\sigma_3$ FAILURE, tsf		1.01	1.87	4.1

TYPE OF TEST:  
Consolidated undrained

SAMPLE TYPE: REMOLDED

DESCRIPTION: SANDY LEAN CLAY (CL)

LL = 27      PL = 16      PI = 11.0

SPECIFIC GRAVITY = 2.68

REMARKS: SPECIMENS REMOLDED TO MAXIMUM DRY DENSITY AT OPTIMUM +2% WATER CONTENT

CLIENT: US ARMY CORPS OF ENGINEERS  
TULSA DISTRICT

PROJECT: PLUM CREEK - BORROW AREA TESTING

SAMPLE LOCATION: BORING: TP-4, 3.0'-5.0', BAGS 1, 2 AND 3, SWD NO. 91/284

PROJ. NO.: 15299      DATE: 13 MAY 1991

TRIAxIAL COMPRESSION TEST

CORPS OF ENGINEERS - SOUTHWESTERN

FIG. NO.



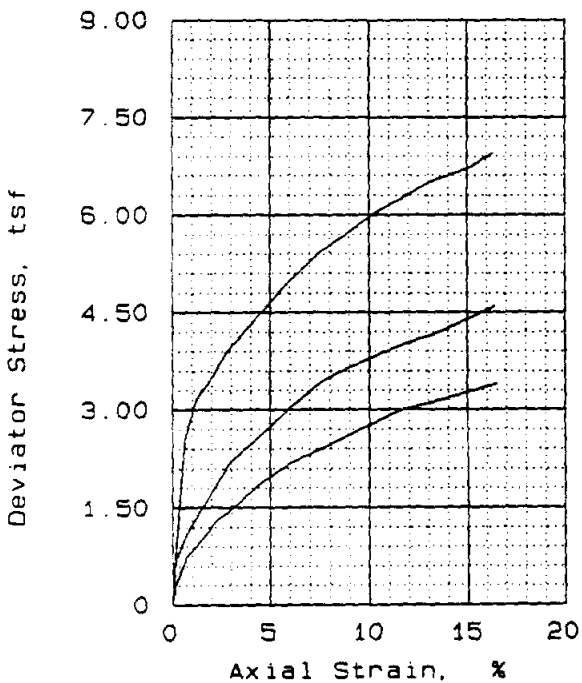
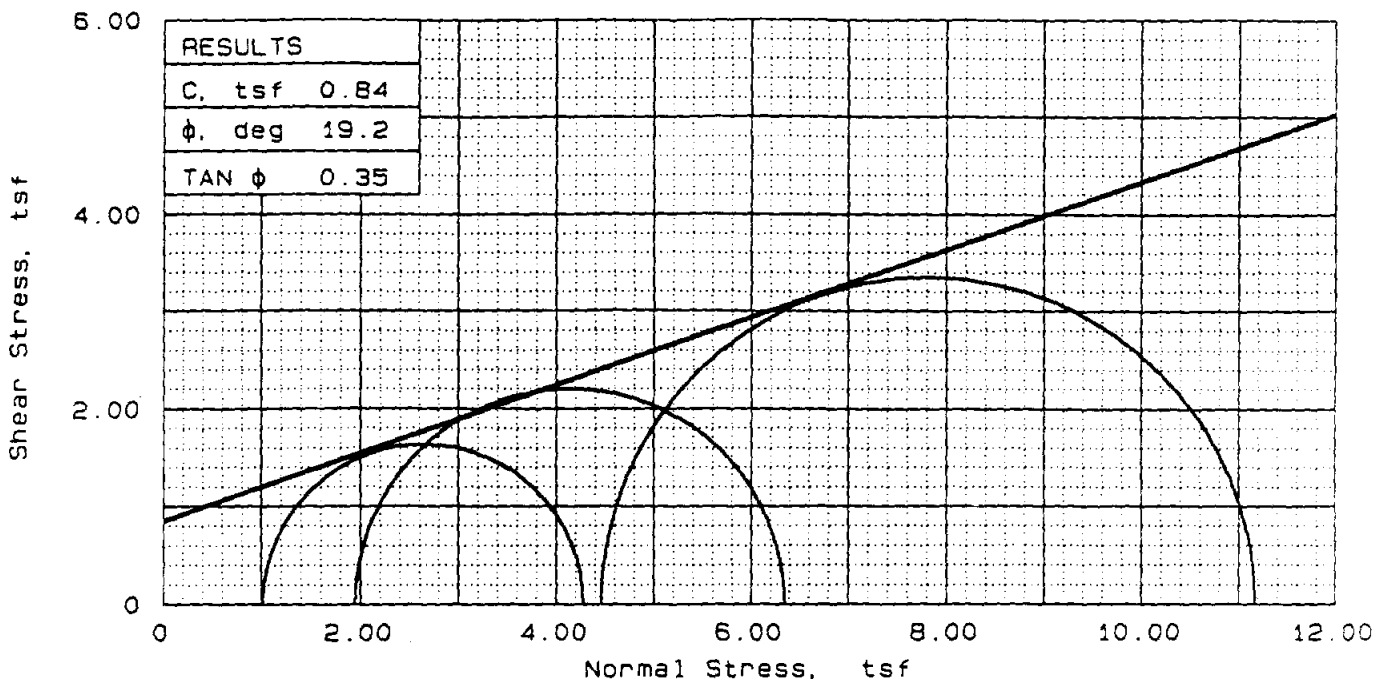

SAMPLE NO.		1	2	3
INITIAL	WATER CONTENT, %	15.5	15.6	15.6
	DRY DENSITY, pcf	113.3	113.0	113.0
	SATURATION, %	87.2	86.8	86.7
	VOID RATIO	0.477	0.480	0.481
	DIAMETER, in	1.42	1.41	1.42
	HEIGHT, in	3.03	3.04	3.03
AT TEST	WATER CONTENT, %	15.7	15.1	14.3
	DRY DENSITY, pcf	117.7	119.2	121.0
	SATURATION, %	100.0	100.0	100.0
	VOID RATIO	0.421	0.404	0.383
	DIAMETER, in	1.40	1.39	1.38
	HEIGHT, in	3.00	2.99	2.99
BACK PRESSURE, tsf		7.34	6.91	7.99
CELL PRESSURE, tsf		8.35	8.86	12.46
FAILURE STRESS, tsf		3.27	4.41	6.71
PORE PRESSURE, tsf				
STRAIN RATE, %/min.		0.001	0.001	0.001
ULTIMATE STRESS, tsf				
PORE PRESSURE, tsf				
$\sigma_1$ FAILURE, tsf		4.27	6.35	11.17
$\sigma_3$ FAILURE, tsf		1.01	1.94	4.46

TYPE OF TEST:  
Consolidated undrained

SAMPLE TYPE: REMOLDED

DESCRIPTION: SILTY SAND (SM)

LL= NP      PL= NP      PI=

SPECIFIC GRAVITY= 2.68

REMARKS: SPECIMENS REMOLDED TO  
MAXIMUM DRY DENSITY AT  
OPTIMUM +2% WATER CONTENT

CLIENT: US ARMY CORPS OF ENGINEERS  
TULSA DISTRICT

PROJECT: PLUM CREEK - BORROW AREA TESTING

SAMPLE LOCATION: BORING: TP-20, 3.0'-5.0',  
BAGS 1, 2 AND 3, SWD NO. 91/286

PROJ. NO.: 15299      DATE: 13 MAY 1991

TRIAxIAL COMPRESSION TEST

CORPS OF ENGINEERS - SOUTHWESTERN

FIG. NO.

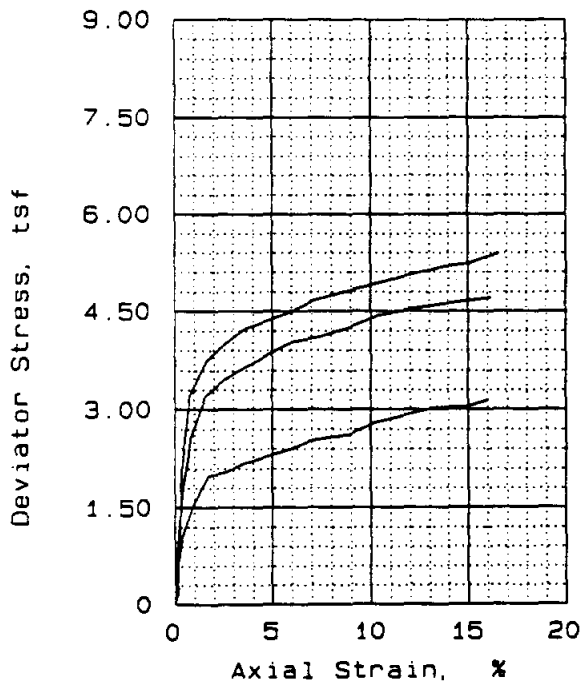
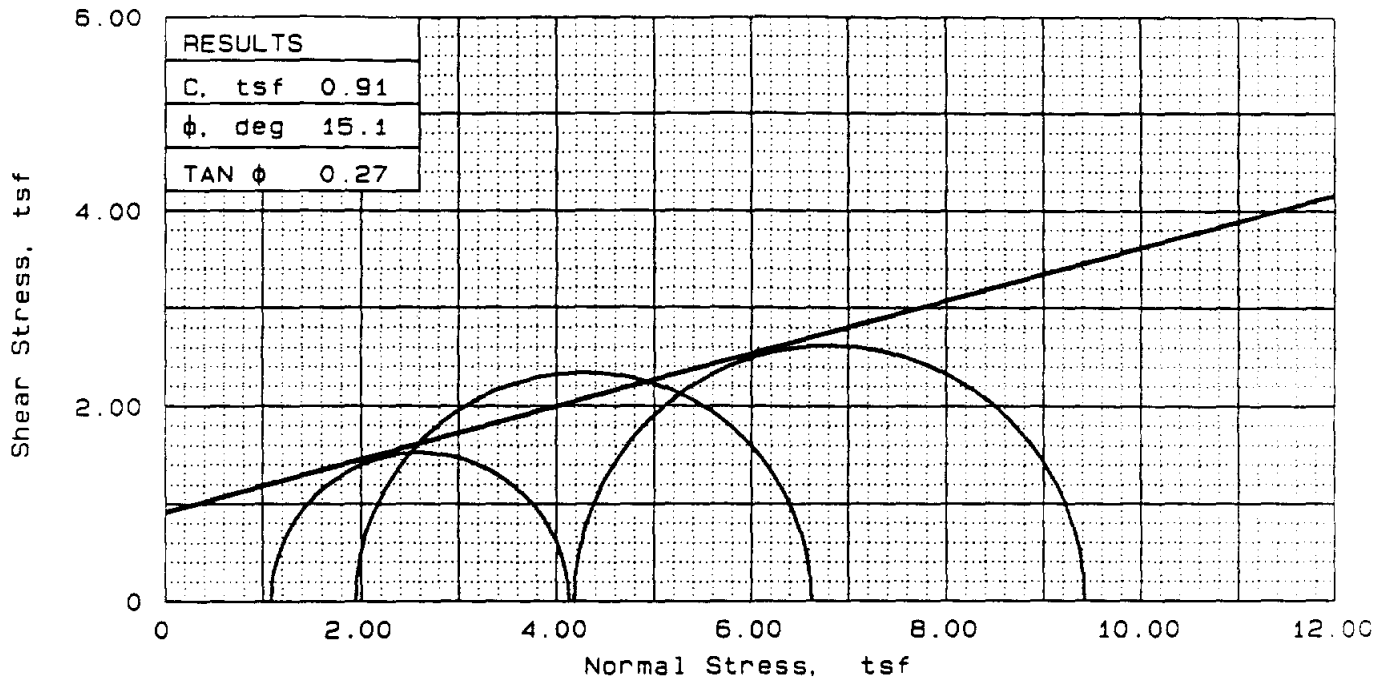

SAMPLE NO.		1	2	3
INITIAL	WATER CONTENT, %	13.0	13.0	13.0
	DRY DENSITY, pcf	116.9	117.4	117.0
	SATURATION, %	81.0	82.1	80.8
	VOID RATIO	0.431	0.425	0.430
	DIAMETER, in	1.42	1.42	1.42
AT TEST	HEIGHT, in	3.04	3.00	3.03
	WATER CONTENT, %	15.8	15.1	15.1
	DRY DENSITY, pcf	117.5	119.1	119.1
	SATURATION, %	100.0	100.0	100.0
	VOID RATIO	0.424	0.405	0.405
AT TEST	DIAMETER, in	1.42	1.41	1.43
	HEIGHT, in	3.02	2.99	2.92
BACK PRESSURE, tsf		7.06	6.34	6.34
CELL PRESSURE, tsf		8.14	8.28	10.51
FAILURE STRESS, tsf		3.05	4.68	5.24
PORE PRESSURE, tsf				
STRAIN RATE, %/min.		0.001	0.001	0.001
ULTIMATE STRESS, tsf				
PORE PRESSURE, tsf				
$\sigma_1$ FAILURE, tsf		4.13	6.63	9.42
$\sigma_3$ FAILURE, tsf		1.08	1.94	4.18

TYPE OF TEST:  
Consolidated undrained

SAMPLE TYPE: REMOLDED

DESCRIPTION: SILTY SAND (SM)

LL= NP      PL= NP      PI=

SPECIFIC GRAVITY= 2.68

REMARKS: SPECIMENS REMOLDED TO  
MAXIMUM DRY DENSITY AT  
OPTIMUM WATER CONTENT

CLIENT: US ARMY CORPS OF ENGINEERS  
TULSA DISTRICT

PROJECT: PLUM CREEK - BORROW AREA TESTING

SAMPLE LOCATION: BORING: TP-20, 3.0'-5.0',  
BAGS 1, 2 AND 3, SWD NO. 91/286

PROJ. NO.: 15299      DATE: MAY 1991

TRIAxIAL COMPRESSION TEST

CORPS OF ENGINEERS - SOUTHWESTERN

FIG. NO.

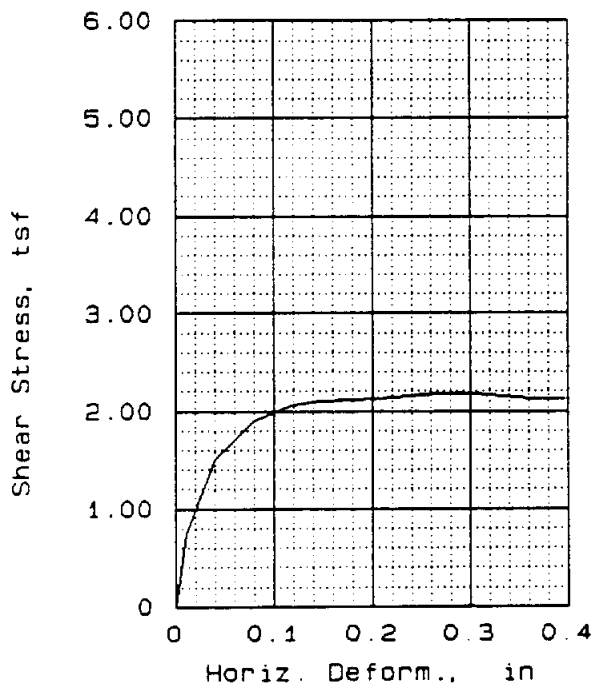
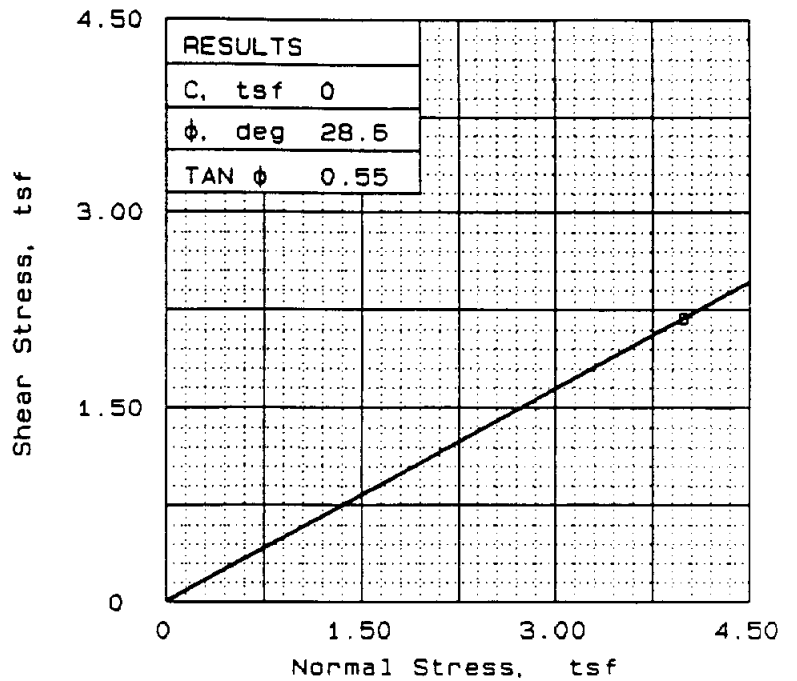
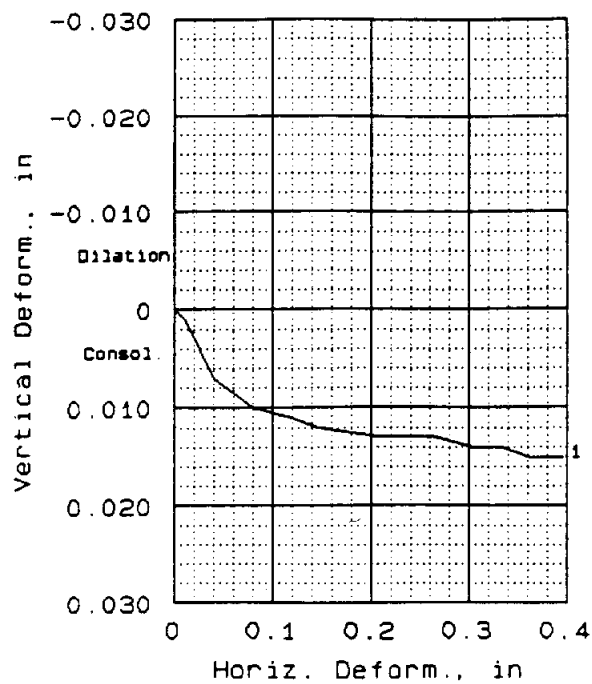

SAMPLE NO.		1
INITIAL	WATER CONTENT, %	15.3
	DRY DENSITY, pcf	115.2
	SATURATION, %	90.8
	VOID RATIO	0.452
	SIDE LENGTH, in	3.00
	HEIGHT, in	1.00
AT TEST	WATER CONTENT, %	15.1
	DRY DENSITY, pcf	119.2
	SATURATION, %	100.3
	VOID RATIO	0.404
	SIDE LENGTH, in	3.39
	HEIGHT, in	0.97
NORMAL STRESS, tsf		4.00
MAX. SHEAR, tsf		2.19
STRAIN RATE, %/min.		0.002
ULT. SHEAR, tsf		

SAMPLE DATA  
 SAMPLE TYPE: REMOLDED  
 DESCRIPTION: SANDY LEAN CLAY  
 (CL)  
 LL= 27      PL= 15      PI= 11.0  
 SPECIFIC GRAVITY= 2.68  
 REMARKS: REMOLDED AT OPTIMUM  
 MOISTURE CONTENT AND MAX  
 DENSITY

FIG. NO.

CLIENT: US ARMY CORPS OF ENGINEERS  
 TULSA DISTRICT  
 PROJECT: PLUM CREEK - BORROW AREA TESTING  
 SAMPLE LOCATION: BORING: TP-4, BAGS 1-3  
 3.0-5.0, SWD LAB NO. 91/284  
 PROJ. NO.: 15299      DATE: MAY 1991

DIRECT SHEAR TEST

CORPS OF ENGINEERS - SOUTHWESTERN

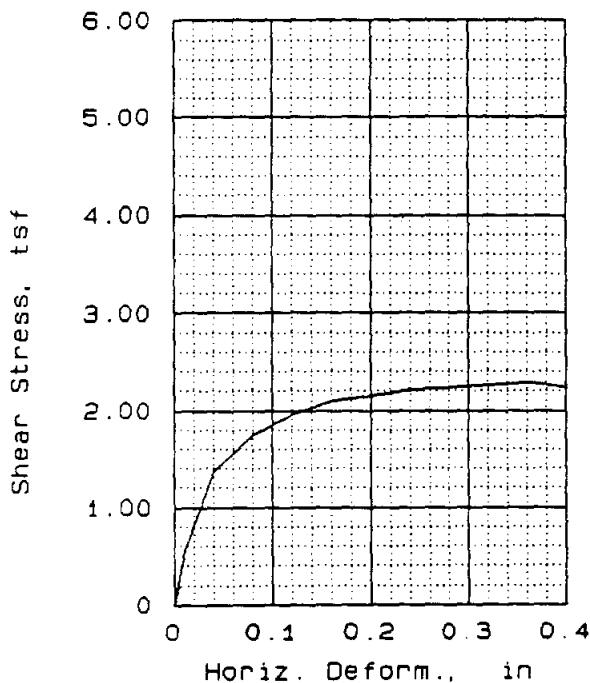
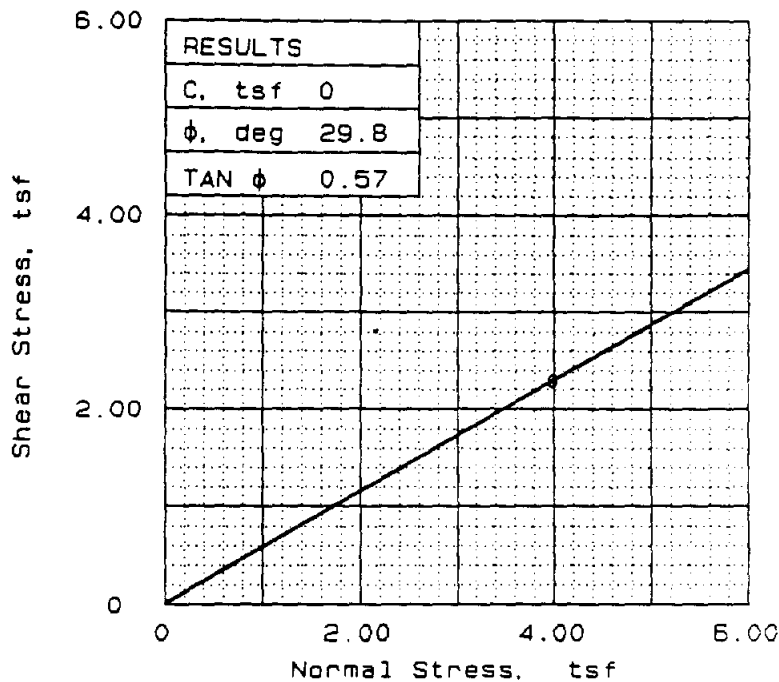
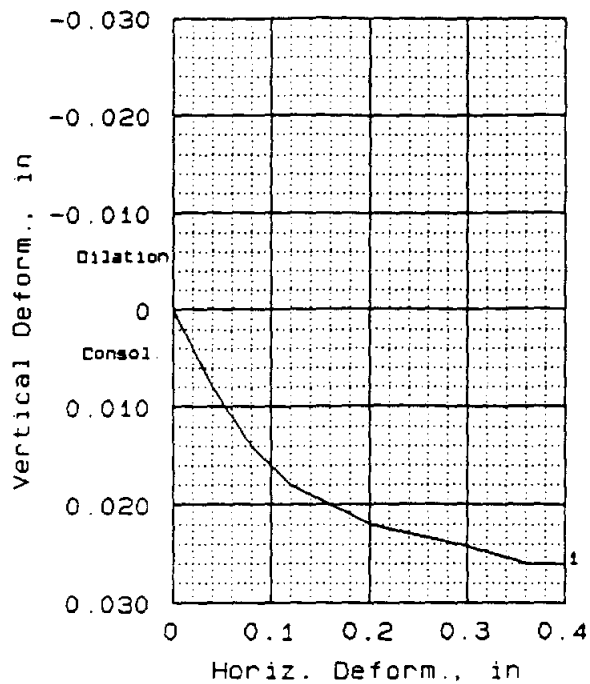

SAMPLE NO.		1
INITIAL	WATER CONTENT, %	12.9
	DRY DENSITY, pcf	115.8
	SATURATION, %	77.5
	VOID RATIO	0.445
AT TEST	SIDE LENGTH, in	3.00
	HEIGHT, in	1.00
	WATER CONTENT, %	14.8
	DRY DENSITY, pcf	120.3
AT TEST	SATURATION, %	101.3
	VOID RATIO	0.390
	SIDE LENGTH, in	3.39
	HEIGHT, in	0.96
NORMAL STRESS, tsf		4.00
MAX. SHEAR, tsf		2.29
STRAIN RATE, %/min.		0.002
ULT. SHEAR, tsf		

**SAMPLE DATA**  
 SAMPLE TYPE: REMOLDED  
 DESCRIPTION: SANDY LEAN CLAY (CL)  
 LL= 27      PL= 16      PI= 11.0  
 SPECIFIC GRAVITY= 2.68  
 REMARKS: REMOLDED AT -2 PERCENT OF OPTIMUM MOISTURE CONTENT AND MAXIMUM DENSITY  
 FIG. NO.

CLIENT: US ARMY CORPS OF ENGINEERS  
 TULSA DISTRICT  
 PROJECT: PLUM CREEK - BORROW AREA TESTING  
 SAMPLE LOCATION: BORING: TP-4, BAGS 1-3  
 3.0-5.0, SWD LAB NO. 91/284  
 PROJ. NO.: 15299      DATE: MAY 1991  
 DIRECT SHEAR TEST  
**CORPS OF ENGINEERS - SOUTHWESTERN**

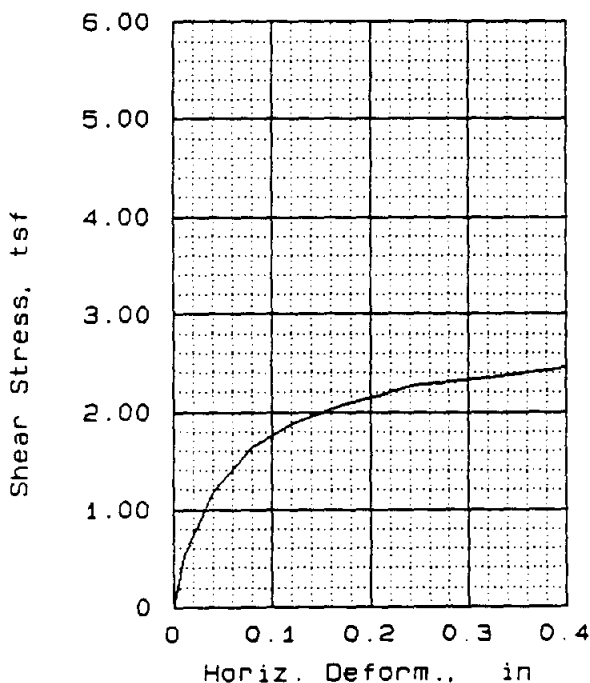
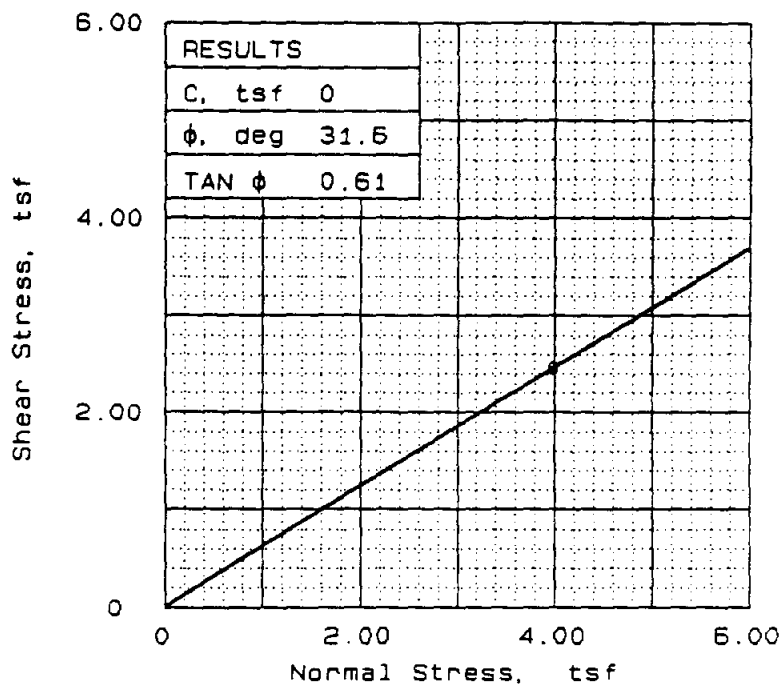
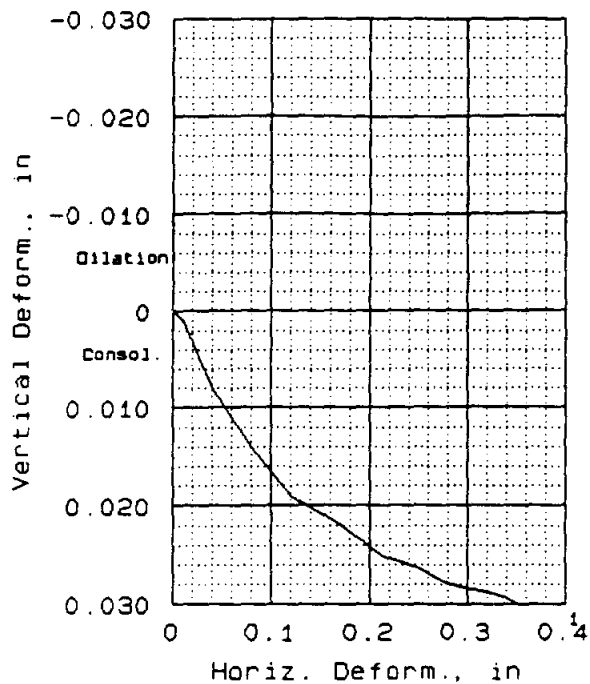

SAMPLE NO.		1
INITIAL	WATER CONTENT, %	11.5
	DRY DENSITY, pcf	117.2
	SATURATION, %	72.1
	VOID RATIO	0.428
	SIDE LENGTH, in	3.00
	HEIGHT, in	1.00
AT TEST	WATER CONTENT, %	14.2
	DRY DENSITY, pcf	121.4
	SATURATION, %	100.8
	VOID RATIO	0.378
	SIDE LENGTH, in	3.39
	HEIGHT, in	0.97
NORMAL STRESS, tsf		4.00
MAX. SHEAR, tsf		2.45
STRAIN RATE, %/min.		0.002
ULT. SHEAR, tsf		

**SAMPLE DATA**  
 SAMPLE TYPE: REMOLDED  
 DESCRIPTION: SILTY SAND (SM)  
 LL=            PL=            PI=  
 SPECIFIC GRAVITY= 2.68  
 REMARKS: REMOLDED AT -2 PERCENT  
 OF OPTIMUM MOISTURE CONTENT  
 AT MAXIMUM DRY DENSITY

CLIENT: US ARMY CORPS OF ENGINEERS  
 TULSA DISTRICT  
 PROJECT: PLUM CREEK - BORROW AREA TESTING  
 SAMPLE LOCATION: BORING: TP-20, BAGS 1-3  
 3.0-5.0, SWD LAB NO. 91/286  
 PROJ NO.: 15299                      DATE: MAY 1991

DIRECT SHEAR TEST

**CORPS OF ENGINEERS - SOUTHWESTERN**

FIG. NO.

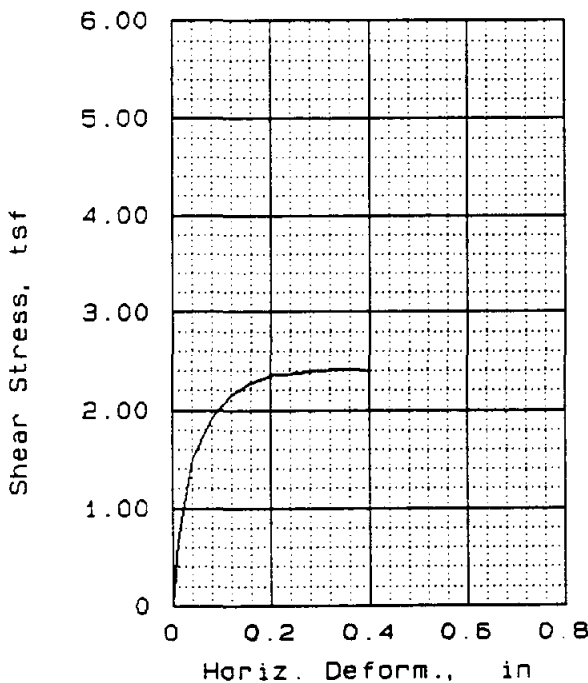
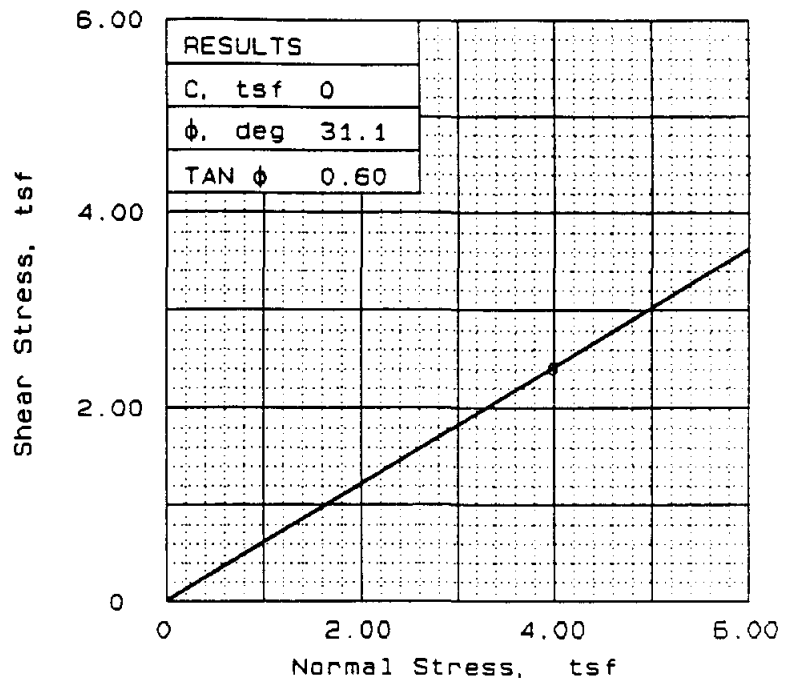
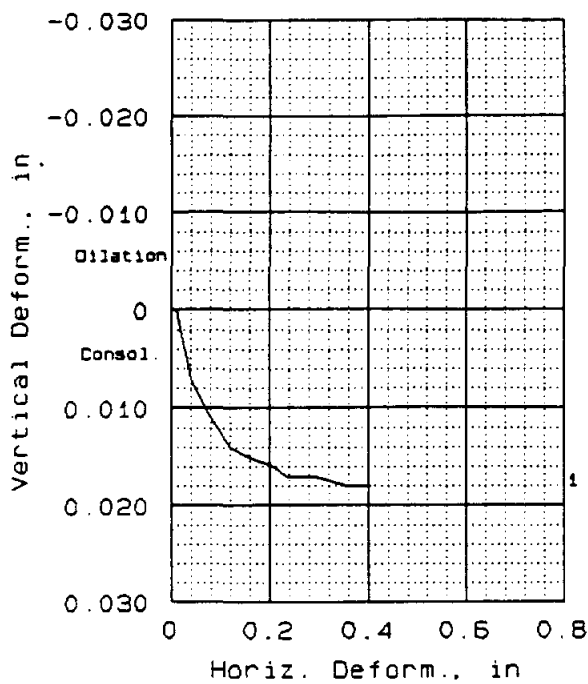

SAMPLE NO.		1
INITIAL	WATER CONTENT, %	17.2
	DRY DENSITY, pcf	115.3
	SATURATION, %	102.2
	VOID RATIO	0.451
	SIDE LENGTH, in	3.00
	HEIGHT, in	1.00
AT TEST	WATER CONTENT, %	14.1
	DRY DENSITY, pcf	122.4
	SATURATION, %	102.9
	VOID RATIO	0.367
	SIDE LENGTH, in	3.39
	HEIGHT, in	0.94
NORMAL STRESS, tsf		4.00
MAX. SHEAR, tsf		2.41
STRAIN RATE, %/min.		0.002
ULT. SHEAR, tsf		

SAMPLE DATA  
 SAMPLE TYPE: REMOLDED  
 DESCRIPTION: SANDY LEAN CLAY  
 (CL)  
 LL= 27      PL= 16      PI= 11.0  
 SPECIFIC GRAVITY= 2.68  
 REMARKS: REMOLDED AT +2 PERCENT  
 OF OPTIMUM MOISTURE CONTENT  
 AT MAXIMUM DRY DENSITY

FIG. NO.

CLIENT: US ARMY CORPS OF ENGINEERS  
 TULSA DISTRICT  
 PROJECT: PLUM CREEK - BORROW AREA TESTING  
 SAMPLE LOCATION: BORING: TP-4, BAGS 1-3  
 3.0-5.0, SWD LAB NO. 91/284  
 PROJ. NO.: 15299      DATE: MAY 1991

DIRECT SHEAR TEST

CORPS OF ENGINEERS - SOUTHWESTERN

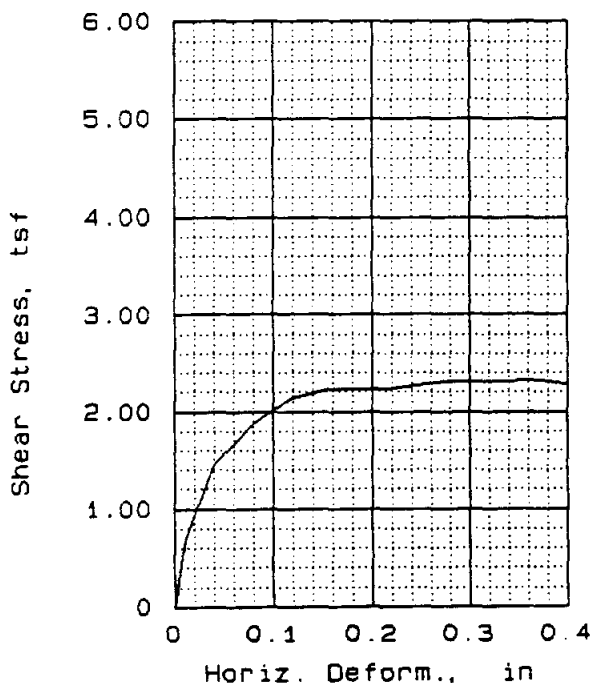
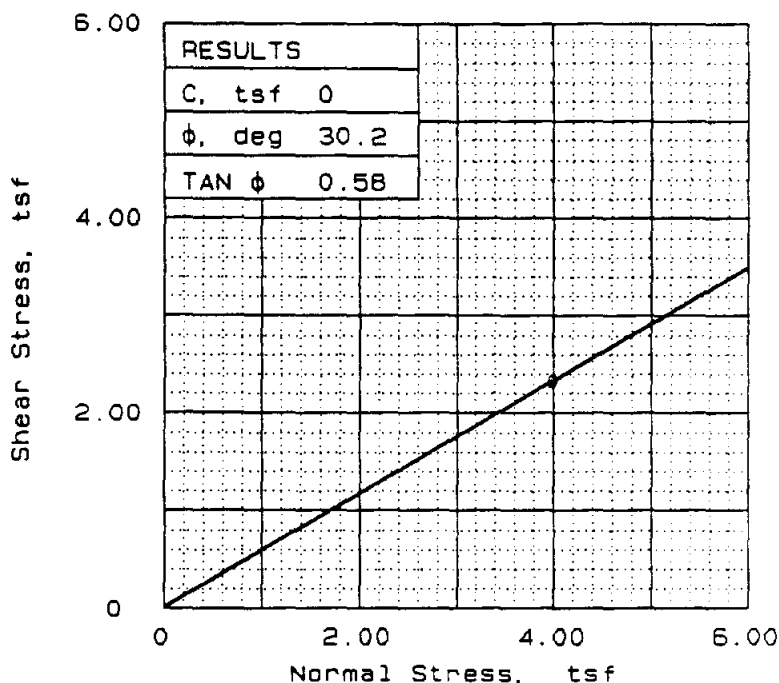
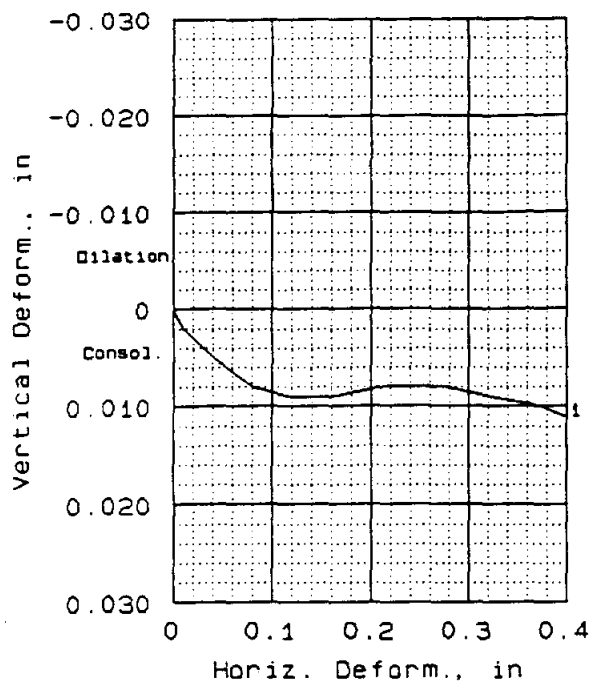

SAMPLE NO.		1
INITIAL	WATER CONTENT, %	15.6
	DRY DENSITY, pcf	117.3
	SATURATION, %	97.7
	VOID RATIO	0.427
	SIDE LENGTH, in	3.00
	HEIGHT, in	1.00
AT TEST	WATER CONTENT, %	13.2
	DRY DENSITY, pcf	124.7
	SATURATION, %	103.5
	VOID RATIO	0.341
	SIDE LENGTH, in	3.39
	HEIGHT, in	0.94
NORMAL STRESS, tsf		4.00
MAX. SHEAR, tsf		2.33
STRAIN RATE, %/min.		0.002
ULT. SHEAR, tsf		

**SAMPLE DATA**  
 SAMPLE TYPE: REMOLDED  
 DESCRIPTION: SILTY SAND (SM)  
 LL=            PL=            PI=  
 SPECIFIC GRAVITY= 2.68  
 REMARKS: REMOLDED AT +2 PERCENT  
 OF OPTIMUM MOISTURE CONTENT  
 AT MAXIMUM DRY DENSITY

CLIENT: US ARMY CORPS OF ENGINEERS  
 TULSA DISTRICT  
 PROJECT: PLUM CREEK - BORROW AREA TESTING  
 SAMPLE LOCATION: BORING: TP-20, BAGS 1-3  
 3.0-5.0, SWD LAB NO. 91/286  
 PROJ. NO.: 15299                      DATE: MAY 1991

DIRECT SHEAR TEST

**CORPS OF ENGINEERS - SOUTHWESTERN**

FIG. NO.

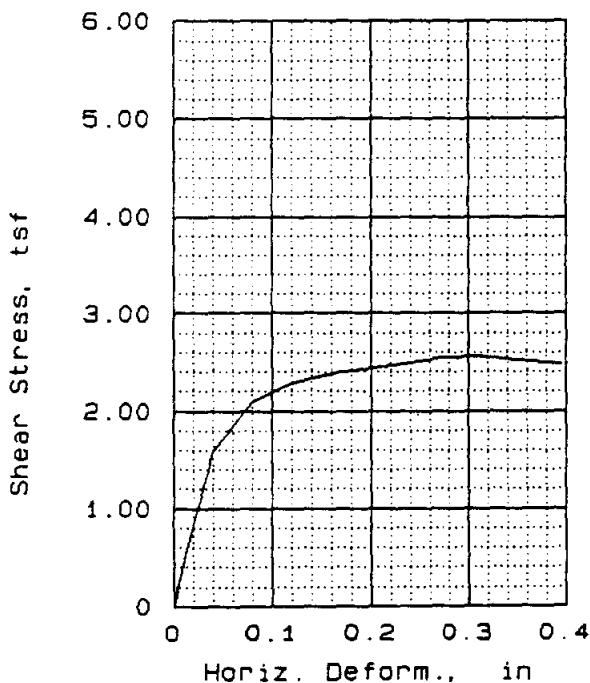
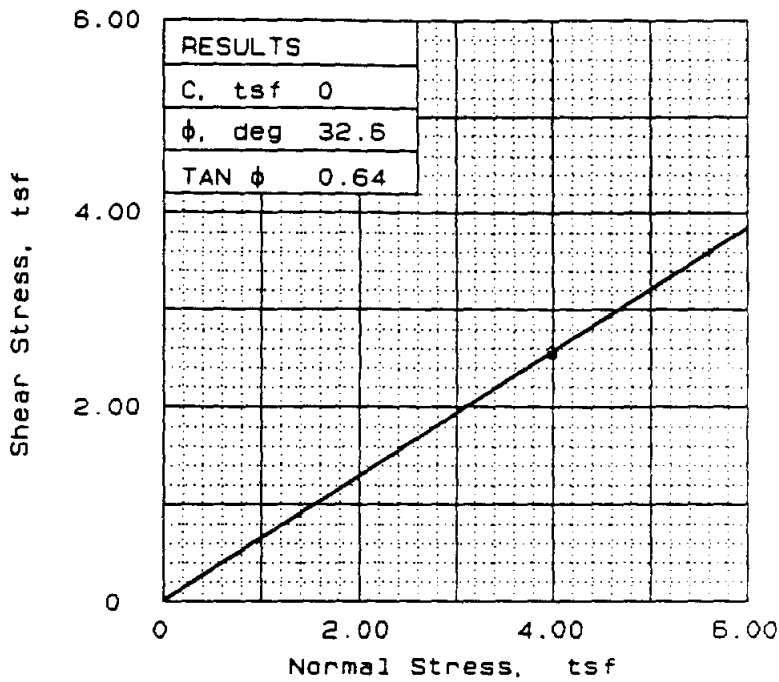
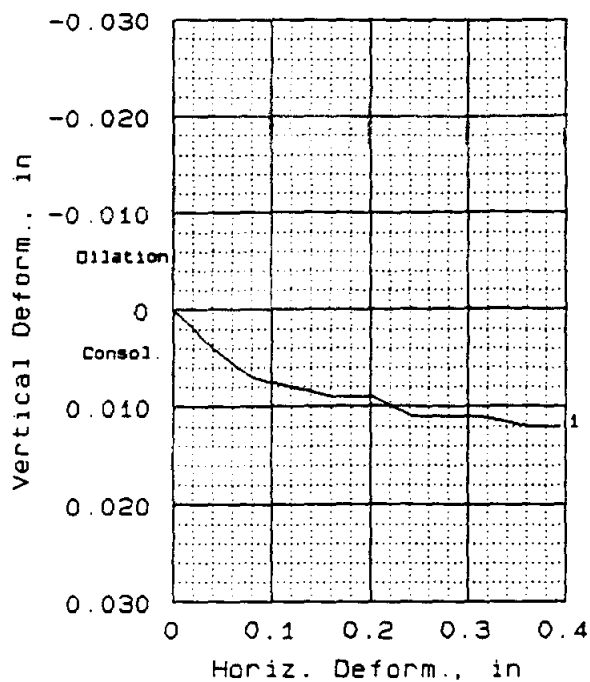

SAMPLE NO.		1
INITIAL	WATER CONTENT, %	13.6
	DRY DENSITY, pcf	117.8
	SATURATION, %	87.0
	VOID RATIO	0.420
	SIDE LENGTH, in	3.00
	HEIGHT, in	1.00
AT TEST	WATER CONTENT, %	13.7
	DRY DENSITY, pcf	122.7
	SATURATION, %	100.8
	VOID RATIO	0.363
	SIDE LENGTH, in	3.39
	HEIGHT, in	0.95
NORMAL STRESS, tsf		4.00
MAX. SHEAR, tsf		2.56
STRAIN RATE, %/min.		0.002
ULT. SHEAR, tsf		

SAMPLE DATA  
 SAMPLE TYPE: REMOLDED  
 DESCRIPTION: SILTY SAND (SM)  
 LL=            PL=            PI=  
 SPECIFIC GRAVITY= 2.68  
 REMARKS: REMOLDED AT OPTIMUM  
 MOISTURE CONTENT AND MAXIMUM  
 DRY DENSITY  
 FIG. NO.

CLIENT: US ARMY CORPS OF ENGINEERS  
 TULSA DISTRICT  
 PROJECT: PLUM CREEK - BORROW AREA TESTING  
 SAMPLE LOCATION: BORING: TP-20, BAGS 1-3  
 3.0-5.0, SWD LAB NO. 91/286  
 PROJ. NO.: 15299                      DATE: MAY 1991  
 DIRECT SHEAR TEST  
 CORPS OF ENGINEERS - SOUTHWESTERN





APPENDIX 5

DESIGN AND COST ESTIMATES

TABLE OF CONTENTS

	<u>Page</u>
GENERAL . . . . .	5- 1
LANDS . . . . .	5- 1
EMBANKMENT . . . . .	5- 1
OUTLET WORKS . . . . .	5- 1
SPELLWAY . . . . .	5- 2
RIGHT ABUTMENT ACCESS ROAD . . . . .	5- 2
RELOCATIONS . . . . .	5- 2
Utilities to be Protected In Place . . . . .	5- 2
Utilities to be Relocated . . . . .	5- 3
SURVEYING AND MAPPING . . . . .	5- 4
Maps Available . . . . .	5- 4
Completed Surveys . . . . .	5- 4
Additional Surveying and Mapping Required . . . . .	5- 4
CLEARING . . . . .	5- 4
Areas to be Cleared . . . . .	5- 4
Disposal of Cleared Materials . . . . .	5- 4
DIVERSION . . . . .	5- 4
SCHEDULE FOR DESIGN AND CONSTRUCTION . . . . .	5- 5
Design . . . . .	5- 5
Land Acquisition . . . . .	5- 5
Construction . . . . .	5- 5
M-CACES COST ESTIMATE . . . . .	5-17

**TABLE OF CONTENTS** (Continued)

	<b><u>Page</u></b>
<b><u>List of Drawings</u></b>	
1/1 General Plan and Index to Drawings . . . . .	5- 6
2/1 Fee Acquisition . . . . .	5- 7
6/1 Right Abutment Access Road . . . . .	5- 8
12/1 Embankment Plan and Profile I . . . . .	5- 9
12/2 Embankment Plan and Profile II . . . . .	5-10
12/3 Embankment Typical Section . . . . .	5-11
12/4 Outlet Works . . . . .	5-12
12/5 Inlet and Outlet Channels . . . . .	5-13
12/6 Spillway Plan and Profile . . . . .	5-14
49/1 Headwall Details . . . . .	5-15
81/1 Relocations . . . . .	5-16

## APPENDIX 5

### DESIGN AND COST ESTIMATES

#### GENERAL

The Plum Creek detention site is located about 3 miles northwest of downtown Wichita Falls, just outside the corporate (city) limits and adjacent to Interstate 44. The detention facility is a flow-through detention site consisting of an embankment, borrow area, and existing topography to provide storage. A general plan of the project is shown on Drawing 1/1.

#### LANDS

Lands to be acquired in fee for the embankment, outlet works, and spillway, about 52.4 acres, are shown on Drawing 2/1. Upstream of the fee acquisition area, a flowage or borrow/flowage easement at elevation 1011 feet National Geodetic Vertical Datum (NGVD), the maximum pool elevation, will be obtained for storage of floodwaters and for borrow operations. Downstream of the spillway, a flowage easement of approximately 7.8 acres will be obtained for spillway discharges, as shown on Drawing 2/1. A road easement of about 1.3 acres will be obtained for the right abutment access road.

#### EMBANKMENT

The embankment has a maximum height of 28.8 feet above the streambed and is approximately 3,074 feet in length. The top of dam is set at elevation 1014 feet NGVD. The plan and profile of the embankment are shown on Drawings 12/1 and 12/2. The embankment is a zoned earthfill structure with 1 vertical (V) on 3 horizontal (H) side slopes and a top width of 15 feet. A typical section of the embankment is shown on Drawing 12/3. Slope protection will consist of 8 inches of suitable soil; the slopes will be seeded, tilled, fertilized, and mulched. A gravel road will be maintained on top of the embankment for maintenance and access and will connect to the right abutment access road. The typical road section is shown on Drawing 12/3.

#### OUTLET WORKS

The outlet structure will be a 30-inch, reinforced-concrete pipe (Drawing 12/4). The outlet channel, approximately 400 feet in length, will have a bottom width of 10 feet and 1V on 3H side slopes. The outlet channel will be lined with 18-inch riprap over 9-inch coarse bedding material for a distance of 50 feet downstream of the headwall apron. The remainder of the outlet channel will be grass lined. The inlet channel will be grass lined and will have a bottom width of 10 feet and 1V on 3H side slopes. The inlet channel is approximately 170 feet in length. The inlet and outlet

channel plan and section are shown on Drawing 12/5. The inlet and outlet headwall plan and sections are shown on Drawing 49/1. A diversion channel will be constructed to divert the east channel to the outlet structure. The diversion channel will have a bottom width of 10 feet and 1V on 3H side slopes, as shown on Drawings 12/1 and 12/2.

#### **SPILLWAY**

The uncontrolled emergency spillway is located in the left abutment. The spillway crest is set at elevation 1002 feet NGVD, the top of flood control pool. The spillway will have a bottom width of 165 feet with 1V on 3H side slopes. Vegetative slope protection will provide for erosion control. A concrete sill is provided at the crest. The spillway plan, profile, and section are shown on Drawing 12/6.

#### **RIGHT ABUTMENT ACCESS ROAD**

The access road will provide access from a county road to and across the embankment. The access road will be the same width as the top of the embankment, 15 feet, with 2-foot shoulders, and will be gravel surfaced. The road will be approximately 1,115 feet long. The access road plan, profile, and typical section are shown on Drawing 6/1.

#### **RELOCATIONS**

Clearances for electrical lines were evaluated in accordance with Engineer Regulation (ER) 1110-2-4401, subject: Clearances for Power and Communication Lines Over Reservoirs, dated 5 September 1986, and the National Electrical Safety Code (NESC), 1990 Edition, Table 232-1.

#### **Utilities To Be Protected In Place**

A 138-kV electrical transmission line supported by steel towers which is owned by Texas Utility Electric Company traverses through the reservoir area in an east-west direction upstream of the embankment, as shown on Drawing 81/1. The embankment goes under the transmission line between towers 4 and 5. All the towers are 85-foot tall except for tower 4 which is 80 foot tall. In September 1991, the low sag elevation between towers 4 and 5 was 1037.98 feet NGVD. The elevation difference between the low sag and the top of the embankment is nearly 24 feet; however, the difference is greater than 24 feet at the location of the embankment since the embankment is close to tower 4. The elevation difference between the top of flood control pool and the maximum pool is nearly 27 feet and 36 feet, respectively. This transmission line does not have to be relocated, but the construction contractor will have to exercise caution and keep borrow operations away from the transmission line. Coordination

with Texas Utility Electric Company is required to determine their requirements for horizontal and vertical clearances prior to completing plans and specifications.

An 18-inch gas line owned by the Lone Star Gas Company crosses the channel in the upper part of the detention site, as shown on Drawing 81/1. The design flood control pool does not inundate the gas line. The maximum pool does inundate about 350 feet of line. It is proposed to not relocate this line since inundation by the maximum pool for a short period of time is similar to existing conditions during a flood event, and the line is not in the borrow area.

#### **Utilities To Be Relocated**

A 12.5-kV, electric distribution line owned by Texas Utility Electric Company running east and west adjacent to the 138-kV transmission line also goes through the reservoir area, as shown on Drawing 81/1. The Texas Utility Electric Company has indicated the poles are 40-foot poles with probably 6 feet in the ground. The embankment goes under the power line between wood poles L and M. The low sag elevation between poles L and M is 1024.75 feet NGVD (September 1991). The elevation difference between the low sag and the top of the flood control pool and the maximum pool is 22.75 feet and 13.75 feet, respectively. The elevation difference between the low sag elevation and the top of the embankment is 10.75 feet. The 10.75-foot difference between the low sag and the top of embankment elevations is insufficient for construction and operation and maintenance and does not have the required clearance. It is proposed that poles L and M be replaced with taller (50-foot) poles to provide sufficient clearance between the low sag and the top of embankment. The low sag between poles I and J is 1010.4 NGVD. This is 0.6 feet below the maximum pool. It is proposed that poles I, J, and K also be replaced with taller poles to prevent inundation of the line in case the detention site reaches maximum pool. The rest of the line low sag elevation varies, as shown on Drawing 81/1. Since the detention site will only have water in it for short periods of time and the remainder of the line is above the maximum pool elevation, it is proposed to not relocate the remainder of the line.

A 12.5-kV electrical transmission line owned by Texas Utility Electric Company enters the project area from the south, as shown on Drawing 81/1. The transmission line is aerial until it reaches the northernmost point at pole P; there the line extends underground to the west. The footprint of the embankment covers pole P. Pole P will be removed along with a portion of the underground line. Pole Q will be relocated approximately 115 feet south of its present location. The relocated line will go west underground from pole Q and reconnect west of the detention site.

## **SURVEYING AND MAPPING**

### **Maps Available**

Topographic maps of areas along Plum Creek in the detention site area were made in March 1986. Contours on 2-foot intervals have been digitized. The topographic maps and CADD files were made available by the city of Wichita Falls. Quadrangle, city, and county maps are also available.

### **Completed Surveys**

Two Corps of Engineers monuments with brass caps were set in the field in the area of the embankment axis. Field surveys were performed to locate the embankment axis, geotechnical borings, and test pits. Field surveys to locate the power poles in the area were accomplished and furnished by the city of Wichita Falls.

### **Additional Surveying and Mapping Required**

Field surveys of the channel invert will be required for design of the inlet, outlet, and diversion channels for contract plans and specifications.

## **CLEARING**

### **Areas To Be Cleared**

Clearing will be restricted to the borrow area, the embankment, the outlet works, the spillway, and the right abutment access road construction areas.

### **Disposal Of Cleared Materials**

Cleared material will become the property of the construction contractor for removal from the project site. The material may be burned subject to the safety of the burning operations and State and local laws governing such operations. In certain cases and areas, burial may be permitted. Disposal of cleared material will be detailed in the contract specifications.

## **DIVERSION**

Care and control of water will be the contractor's responsibility. The contractor will develop a plan for the care and control of water during construction, and the plan will be approved by the contracting officer. The existing channels will be kept open during construction until the outlet works and diversion channel are complete. Permanent embankment and channel work will be constructed in areas that are free of water. Temporary diversion ditches may be constructed as required and pumps provided

as necessary during construction. Temporary diversion ditches will be backfilled and the ground restored.

#### **SCHEDULE FOR DESIGN AND CONSTRUCTION**

Approximately 2 years will be required for design and construction.

##### **Design**

Approximately 9 months will be required to prepare contract plans and specifications.

##### **Land Acquisition**

Following construction approval and signing of the Local Cooperation Agreement, approximately 13 months will be required for real estate acquisition.

##### **Construction**

After acquisition of lands, the construction contract will be advertised; construction of the project should be complete in about 1 year.





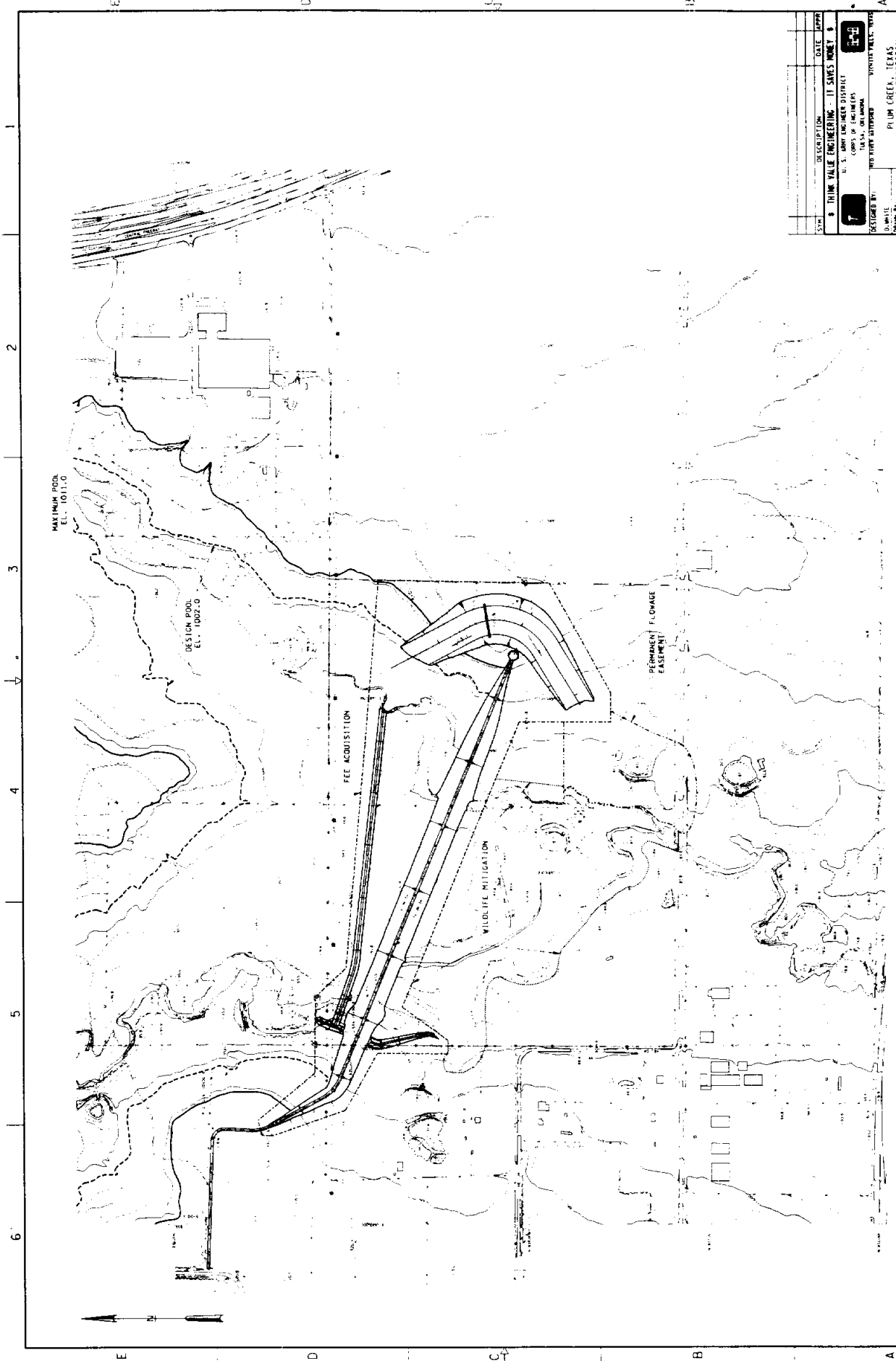

DATE	1999
DESCRIPTION	PLUM CREEK, TEXAS LOCAL FLOOD PROTECTION
DESIGNED BY	D. WHITE
CHECKED BY	H. HANCOCK
DATE	10/11/99
SCALE	1" = 200'
PROJECT NO.	10000
SHEET NO.	1
TOTAL SHEETS	1

FEE ACQUISITION

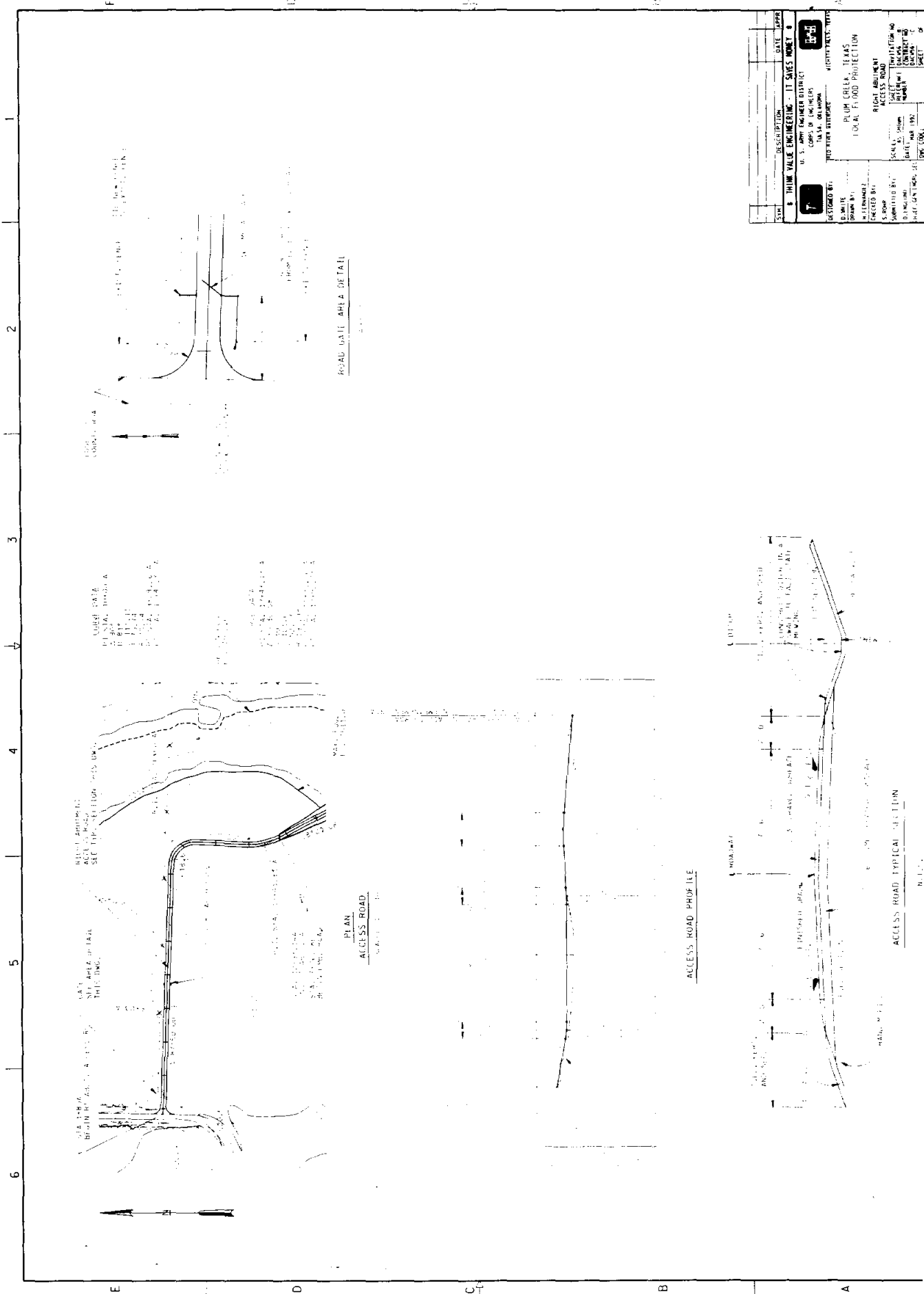

ROAD GATE AREA DETAIL

PLAN  
ACCESS ROAD

ACCESS ROAD PROFILE

ACCESS ROAD TYPICAL SECTION

SYM	DESCRIPTION	DATE	APPR
7	THINK VALUE ENGINEERING - II SALES WORK 8		
U. S. ARMY ENGINEER DISTRICT CORPUS CHRISTI DISTRICT 1000 WEST BENTLEY AUSTIN, TEXAS, TEXAS			
PLUM CREEK, TEXAS LOCAL FLOOD PROTECTION PROJECT ALIGNMENT ACCESS ROAD			
DESIGNED BY	D. J. MCGINNIS	SCALE	AS SHOWN
DRAWN BY	M. F. HENNING	DATE	MAR 1982
CHECKED BY	S. BROWN	PROJECT NO.	1000 WEST BENTLEY
APPROVED BY	D. J. MCGINNIS	SHEET NO.	1 OF 2
IN CHARGE	J. G. GANTNER, JR.	PROJECT	PLUM CREEK, TEXAS

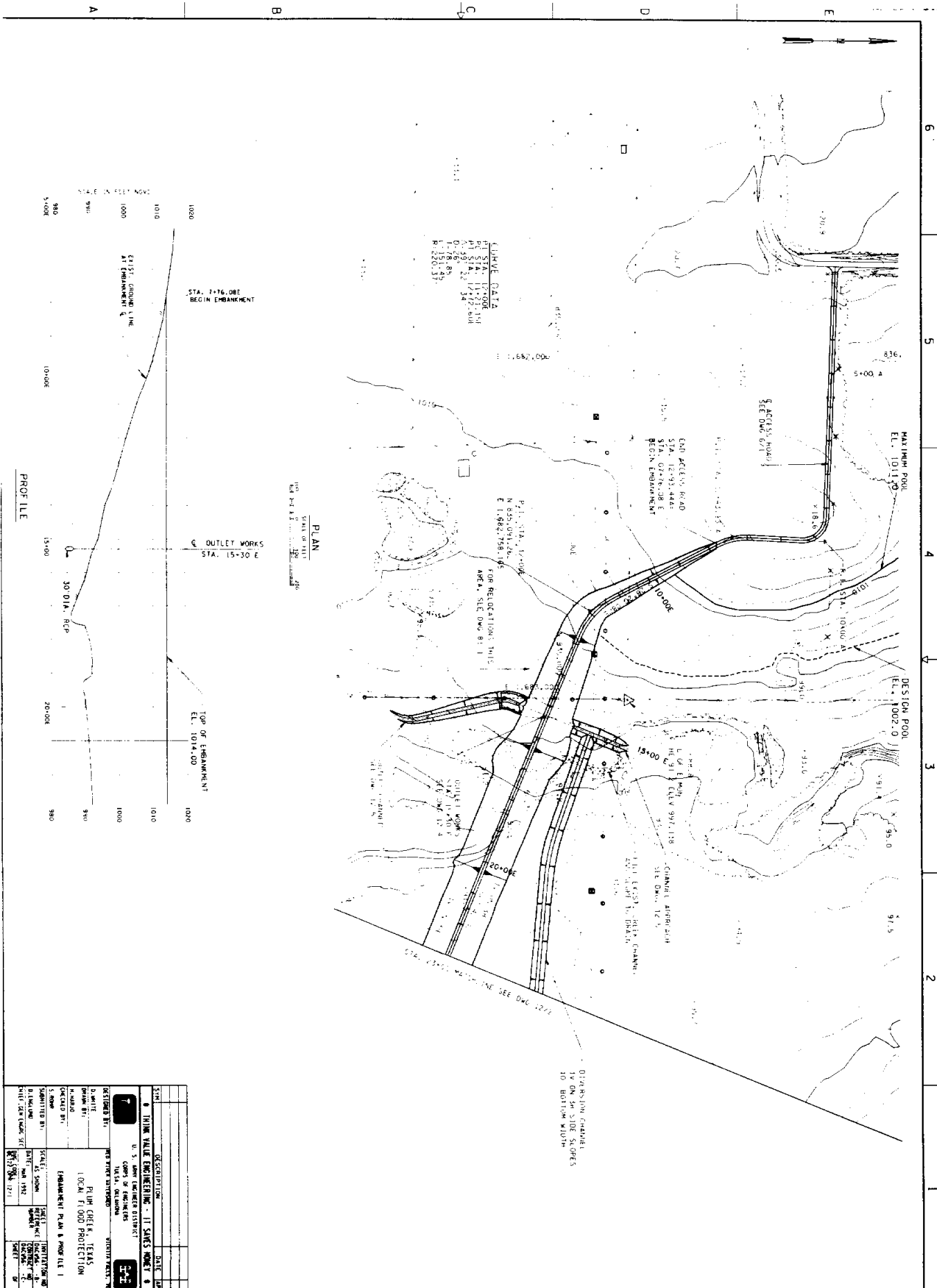

HAVE DATA  
 P.I. STA. 1+000  
 P.O. STA. 1+172.50  
 D. STA. 1+172.50  
 H. STA. 1+172.50  
 R. STA. 1+172.50  
 H. STA. 1+172.50  
 R. STA. 1+172.50

PLAN  
 SCALE OF HORIZ. DIST.  
 1" = 100'

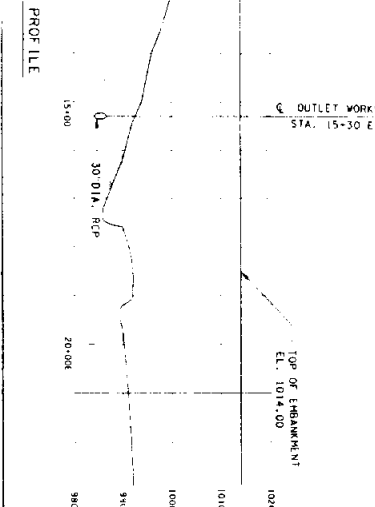

PROFILE

SHEET NO. 1 OF 1	DATE 1942
DRAWN BY H. W. BROWN	CHECKED BY H. W. BROWN
SUBMITTED BY H. W. BROWN	SCALE 1" = 100'
PROJECT NO. 100	SHEET NO. 1
DESCRIPTION U.S. Army Engineer District Tulsa, Oklahoma	TITLE EMBANKMENT PLAN & PROFILE I
DESIGNER H. W. BROWN	PROJECT PLUM CREEK, TEXAS LOCAL FLOOD PROTECTION

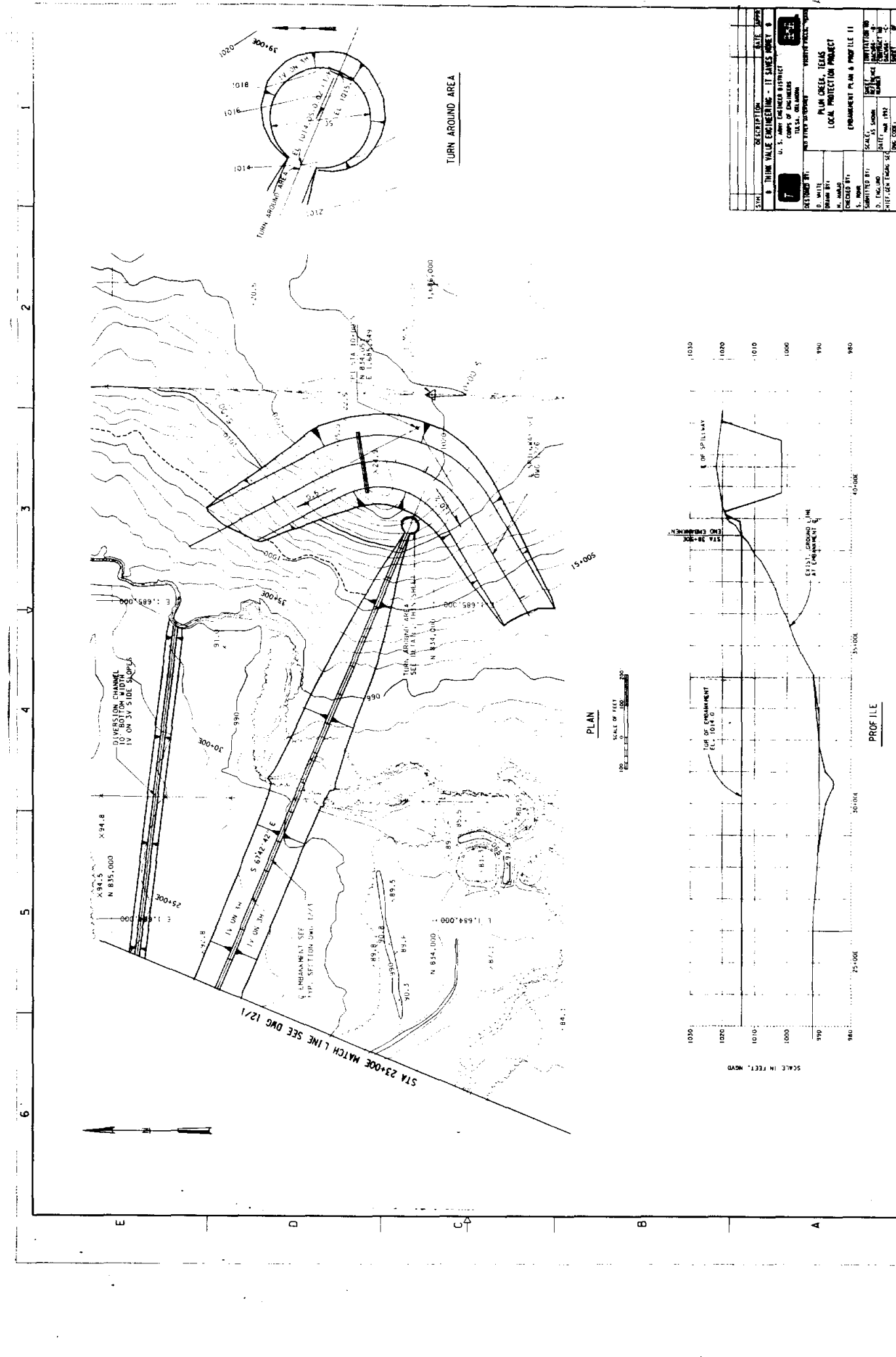

SYMBOL	DESCRIPTION	DATE	APPR.
T	THINK VALUE ENGINEERING - IT'S SAVES MONEY		
41. S. AMY ENGINEER DISTRICT CORPS OF ENGINEERS 116 S. GELBURN HOUSTON, TEXAS			
DESIGNED BY	D. WHITE		
DRAWN BY	H. HANCOCK		
CHECKED BY	S. HARRIS		
SUBMITTED BY	D. F. LAMON		
SCALE	AS SHOWN		
DATE	MAY 1952		
PROJECT NO.	100-1000		
DESIGNER'S OFFICE	HOUSTON, TEXAS		
PROJECT NO.	100-1000		
DATE	MAY 1952		
SCALE	AS SHOWN		
PROJECT NO.	100-1000		
DESIGNER'S OFFICE	HOUSTON, TEXAS		

TURN AROUND AREA

PLAN

SCALE OF FEET  
 1" = 100'

PROFILE

SCALE IN FEET, NGVD



DATE	APP'D	SECTION
7		
U.S. ARMY ENGINEER DISTRICT CORPS OF ENGINEERS TEXAS DISTRICT		
DESIGNED BY	DRAWN BY	CHECKED BY
SUBMITTED BY	SCALE	DATE
PROJECT NO.	SHEET NO.	TOTAL SHEETS
TITLE: <b>EMBAKMENT TYPICAL SECTION</b> LOCAL FLOOD PROTECTION PLUM CREEK, TEXAS		

6 5 4 3 2 1

E D C B A

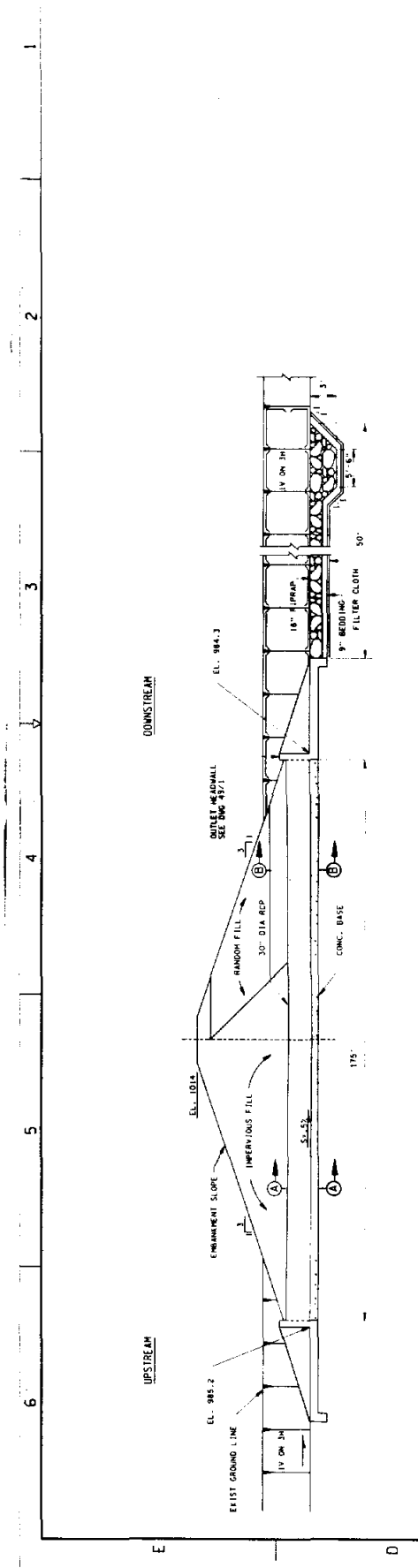

LONGITUDINAL SECTION ALONG  
CENTER LINE OF OUTLET PIPE  
NO SCALE

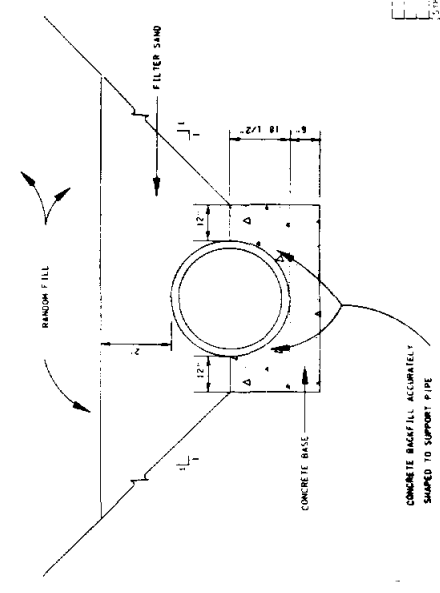

SECTION B-B

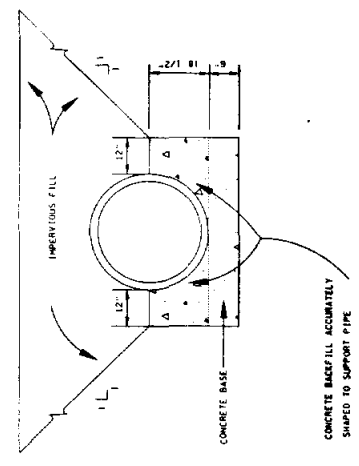

SECTION A-A  
OUTLET PIPE STRUCTURE  
SUPPORT AND BACKFILL

TRINITY VALLE ENGINEERING - IT SAVES MONEY U.S. ARMY ENGINEER DISTRICT COMPANY OF ENGINEERS TULSA, OKLAHOMA 3005 W. 47TH AVENUE OKLAHOMA CITY, OKLAHOMA 73109	
DESIGNED BY: D. WHITE	CHECKED BY: A. JONES
DRAWN BY: S. GARDNER	SUBMITTED BY: D. GARDNER
SCALE: AS SHOWN DATE: JAN 1990	PROJECT: PLUM CREEK, TEXAS LOCAL FLOOD PROTECTION OUTLET WORKS
SHEET: 12 OF 12	DRAWING NO.: 12-12

1 2 3 4 5 6

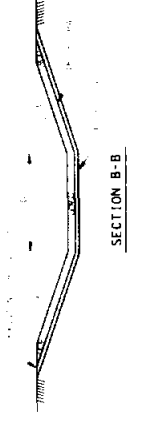
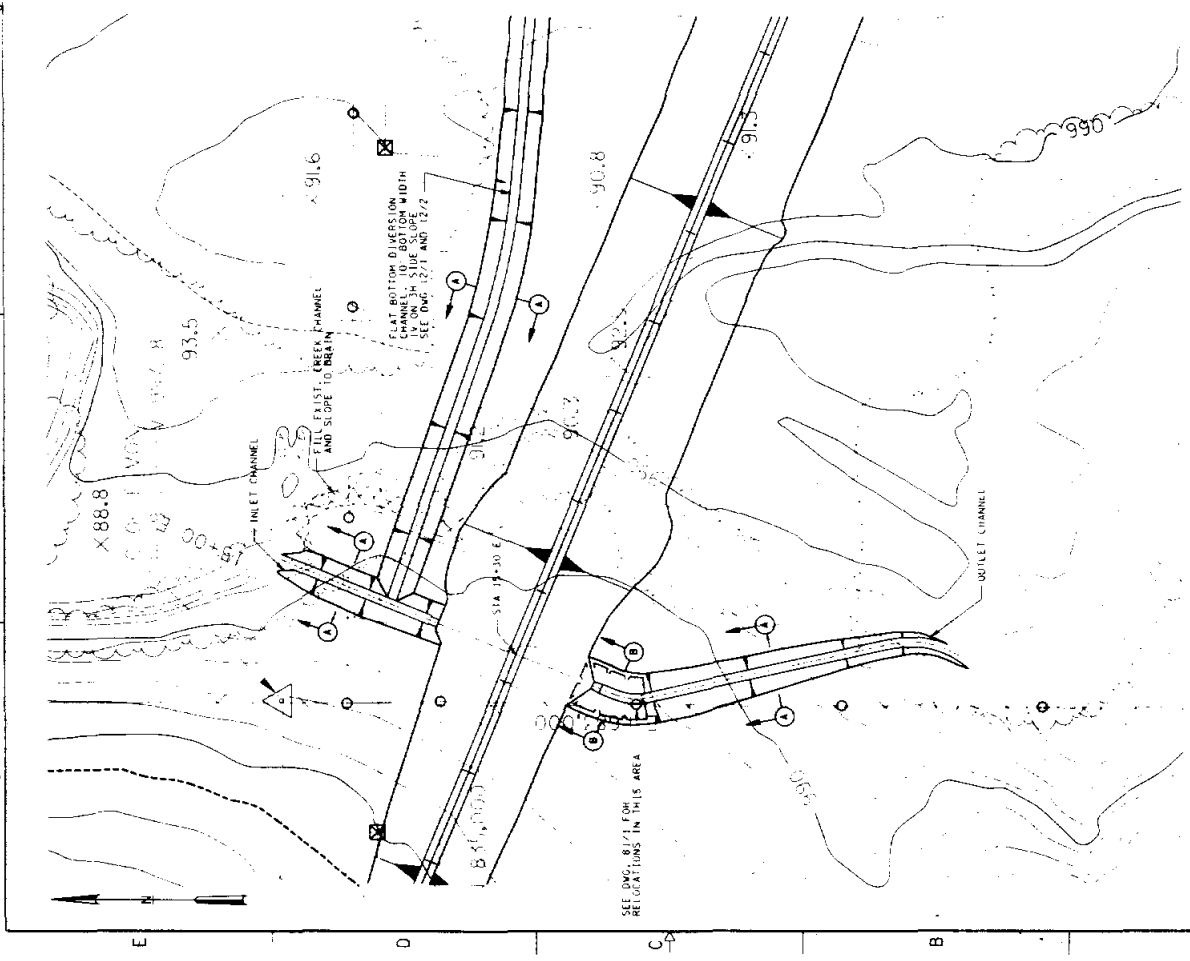

CONTRACT NO. \_\_\_\_\_ DATE \_\_\_\_\_  
 PROJECT TITLE \_\_\_\_\_  
 DRAWING NO. \_\_\_\_\_  
 SHEET NO. \_\_\_\_\_ OF \_\_\_\_\_

**THINK VALUE ENGINEERING - IT SAVES MONEY**  
 U.S. Army Engineer District  
 Corps of Engineers  
 Tulsa, Oklahoma

DESIGNED BY: \_\_\_\_\_  
 DRAWN BY: \_\_\_\_\_  
 CHECKED BY: \_\_\_\_\_

INLET AND OUTLET CHANNELS  
 PLUM CREEK, TEXAS  
 LOCAL FLOOD PROTECTION  
 SCALE: AS SHOWN  
 DATE: MAR 1972  
 PROJECT NO. \_\_\_\_\_  
 SHEET NO. \_\_\_\_\_ OF \_\_\_\_\_

PLAN  
 SCALE OF FEET  
 1" = 50'





6 5 4 3 2 1

E  
D  
C  
B  
A

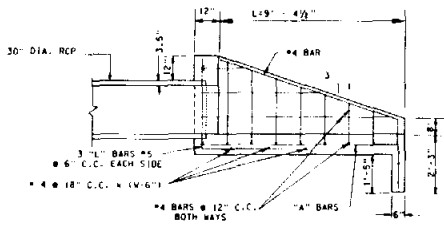

SECTION B-B

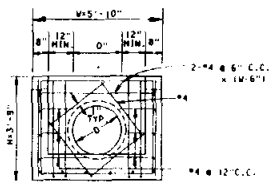

SECTION A-A

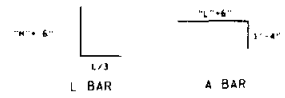

BAR BENDING DIAGRAM

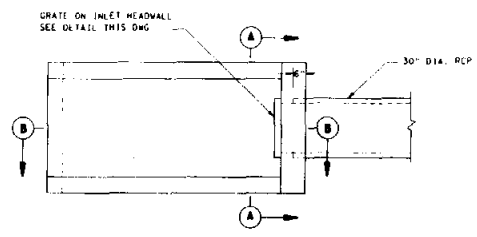

INLET

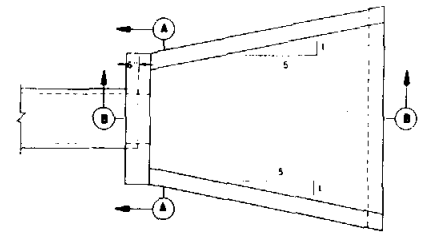

OUTLET

PLAN HEADWALL DETAILS

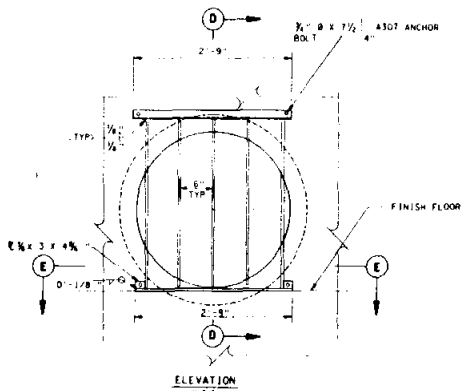

ELEVATION  
N.T.S.

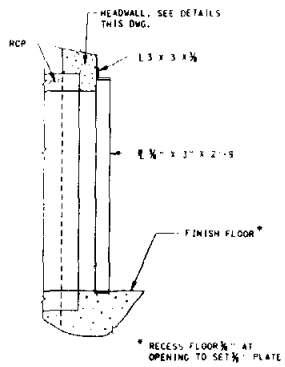

SECTION D-D  
N.T.S.

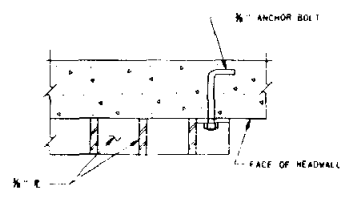

SECTION E-E  
N.T.S.

HEADWALL GRATE DETAILS

DESIGNED BY:	D. WHITE	SCALE:	AS SHOWN	SHEET REFERENCE:	INVIATION NO.:
DRAWN BY:	M. MAJID	DATE:	MAR 1992	CONTRACT NO.:	02122 USA 49-1
CHECKED BY:	S. POH	DATE:	MAR 1992	CONTRACT NO.:	02122 USA 49-1
SUBMITTED BY:		D. ENGINEERING		SHEET NUMBER:	
DESCRIPTION:		HEADWALL DETAILS		SHEET OF:	
PROJECT:		PLUM CREEK, TEXAS		CONTRACT NO.:	
DRAWING NO.:		LOCAL FLOOD PROTECTION		CONTRACT NO.:	
DRAWING NO.:		LOCAL FLOOD PROTECTION		CONTRACT NO.:	

2  
3  
4  
5  
6

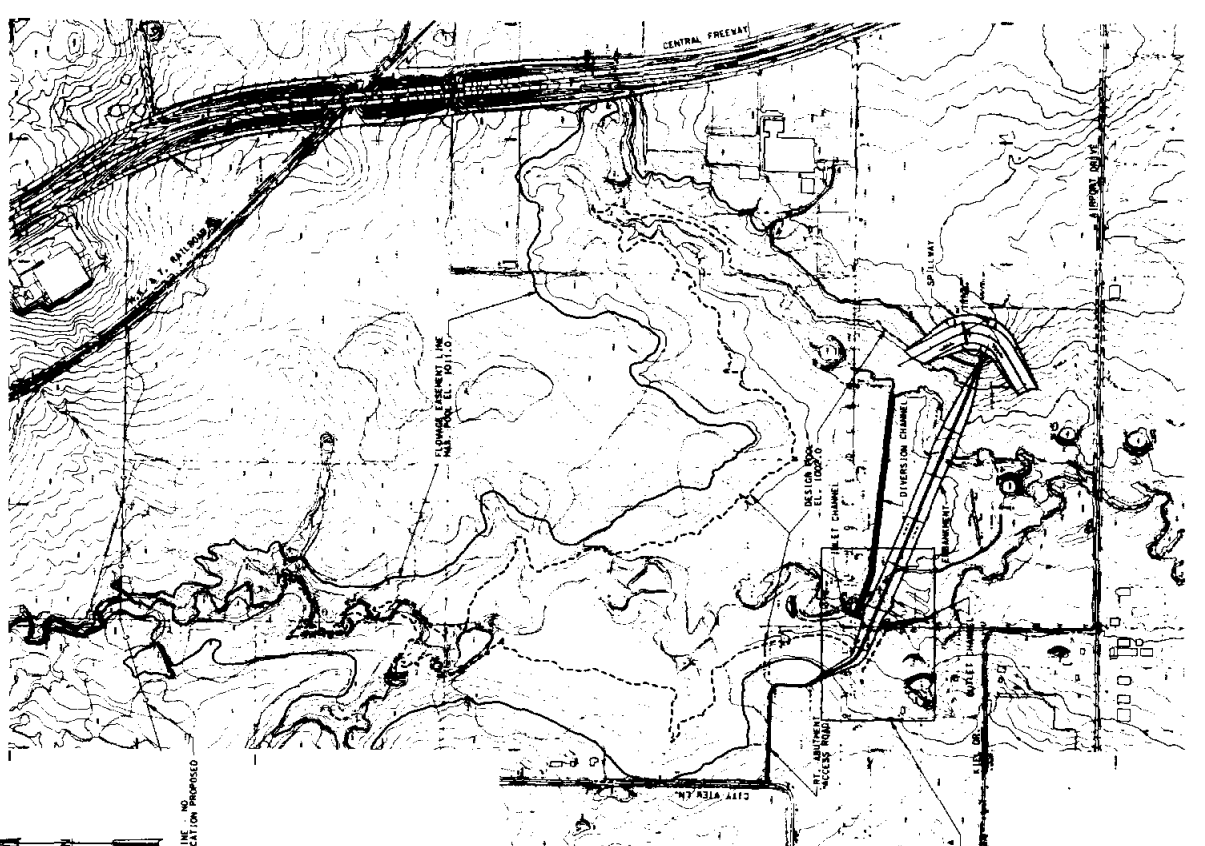

GAS LINE NO. RELOCATION PROPOSED

SEE AREA DETAIL

PLAN RELOCATION

SCALE OF FEET 1" = 200'

POLES 1 THROUGH 4 ARE TO BE REPLACED WITH TALLER POLES

POLE P TO BE REMOVED

RELOCATED BURIED ELECTRIC LINE

RELOCATED POLE O

AREA DETAIL

SCALE OF FEET 1" = 100'

SAG LINE ELEVATIONS	LOCATION	ELEVATION
EAST-WEST POWER POLES 142.5 K.V.		
BETWEEN P. 1 & 2	1015.00	
BETWEEN P. 2 & 3	1015.00	
BETWEEN P. 3 & 4	1015.00	
BETWEEN P. 4 & 5	1015.00	
BETWEEN P. 5 & 6	1015.00	
BETWEEN P. 6 & 7	1015.00	
BETWEEN P. 7 & 8	1015.00	
BETWEEN P. 8 & 9	1015.00	
BETWEEN P. 9 & 10	1015.00	
BETWEEN P. 10 & 11	1015.00	
BETWEEN P. 11 & 12	1015.00	
BETWEEN P. 12 & 13	1015.00	
BETWEEN P. 13 & 14	1015.00	
BETWEEN P. 14 & 15	1015.00	
BETWEEN P. 15 & 16	1015.00	
BETWEEN P. 16 & 17	1015.00	
BETWEEN P. 17 & 18	1015.00	
BETWEEN P. 18 & 19	1015.00	
BETWEEN P. 19 & 20	1015.00	
NORTH/SOUTH POWER POLES 142.5 K.V.		
BETWEEN P. 1 & 2	1016.01	
BETWEEN P. 2 & 3	1015.52	
BETWEEN P. 3 & 4	1015.03	
BETWEEN P. 4 & 5	1014.54	
BETWEEN P. 5 & 6	1014.05	
BETWEEN P. 6 & 7	1013.56	
BETWEEN P. 7 & 8	1013.07	
BETWEEN P. 8 & 9	1012.58	
BETWEEN P. 9 & 10	1012.09	
BETWEEN P. 10 & 11	1011.60	
BETWEEN P. 11 & 12	1011.11	
BETWEEN P. 12 & 13	1010.62	
BETWEEN P. 13 & 14	1010.13	
BETWEEN P. 14 & 15	1009.64	
BETWEEN P. 15 & 16	1009.15	
BETWEEN P. 16 & 17	1008.66	
BETWEEN P. 17 & 18	1008.17	
BETWEEN P. 18 & 19	1007.68	
BETWEEN P. 19 & 20	1007.19	
STEEL TOWERS 1138 K.V.		
BETWEEN T. 1 & 2	1030.44	
BETWEEN T. 2 & 3	1029.33	
BETWEEN T. 3 & 4	1028.22	
BETWEEN T. 4 & 5	1027.11	
BETWEEN T. 5 & 6	1026.00	
BETWEEN T. 6 & 7	1024.89	
BETWEEN T. 7 & 8	1023.78	
BETWEEN T. 8 & 9	1022.67	
BETWEEN T. 9 & 10	1021.56	
BETWEEN T. 10 & 11	1020.45	
BETWEEN T. 11 & 12	1019.34	
BETWEEN T. 12 & 13	1018.23	
BETWEEN T. 13 & 14	1017.12	
BETWEEN T. 14 & 15	1016.01	
BETWEEN T. 15 & 16	1014.90	
BETWEEN T. 16 & 17	1013.79	
BETWEEN T. 17 & 18	1012.68	
BETWEEN T. 18 & 19	1011.57	
BETWEEN T. 19 & 20	1010.46	
BETWEEN T. 20 & 21	1009.35	
BETWEEN T. 21 & 22	1008.24	
BETWEEN T. 22 & 23	1007.13	
BETWEEN T. 23 & 24	1006.02	
BETWEEN T. 24 & 25	1004.91	
BETWEEN T. 25 & 26	1003.80	
BETWEEN T. 26 & 27	1002.69	
BETWEEN T. 27 & 28	1001.58	
BETWEEN T. 28 & 29	1000.47	
BETWEEN T. 29 & 30	999.36	
BETWEEN T. 30 & 31	998.25	
BETWEEN T. 31 & 32	997.14	
BETWEEN T. 32 & 33	996.03	
BETWEEN T. 33 & 34	994.92	
BETWEEN T. 34 & 35	993.81	
BETWEEN T. 35 & 36	992.70	
BETWEEN T. 36 & 37	991.59	
BETWEEN T. 37 & 38	990.48	
BETWEEN T. 38 & 39	989.37	
BETWEEN T. 39 & 40	988.26	
BETWEEN T. 40 & 41	987.15	
BETWEEN T. 41 & 42	986.04	
BETWEEN T. 42 & 43	984.93	
BETWEEN T. 43 & 44	983.82	
BETWEEN T. 44 & 45	982.71	
BETWEEN T. 45 & 46	981.60	
BETWEEN T. 46 & 47	980.49	
BETWEEN T. 47 & 48	979.38	
BETWEEN T. 48 & 49	978.27	
BETWEEN T. 49 & 50	977.16	
BETWEEN T. 50 & 51	976.05	
BETWEEN T. 51 & 52	974.94	
BETWEEN T. 52 & 53	973.83	
BETWEEN T. 53 & 54	972.72	
BETWEEN T. 54 & 55	971.61	
BETWEEN T. 55 & 56	970.50	
BETWEEN T. 56 & 57	969.39	
BETWEEN T. 57 & 58	968.28	
BETWEEN T. 58 & 59	967.17	
BETWEEN T. 59 & 60	966.06	
BETWEEN T. 60 & 61	964.95	
BETWEEN T. 61 & 62	963.84	
BETWEEN T. 62 & 63	962.73	
BETWEEN T. 63 & 64	961.62	
BETWEEN T. 64 & 65	960.51	
BETWEEN T. 65 & 66	959.40	
BETWEEN T. 66 & 67	958.29	
BETWEEN T. 67 & 68	957.18	
BETWEEN T. 68 & 69	956.07	
BETWEEN T. 69 & 70	954.96	
BETWEEN T. 70 & 71	953.85	
BETWEEN T. 71 & 72	952.74	
BETWEEN T. 72 & 73	951.63	
BETWEEN T. 73 & 74	950.52	
BETWEEN T. 74 & 75	949.41	
BETWEEN T. 75 & 76	948.30	
BETWEEN T. 76 & 77	947.19	
BETWEEN T. 77 & 78	946.08	
BETWEEN T. 78 & 79	944.97	
BETWEEN T. 79 & 80	943.86	
BETWEEN T. 80 & 81	942.75	
BETWEEN T. 81 & 82	941.64	
BETWEEN T. 82 & 83	940.53	
BETWEEN T. 83 & 84	939.42	
BETWEEN T. 84 & 85	938.31	
BETWEEN T. 85 & 86	937.20	
BETWEEN T. 86 & 87	936.09	
BETWEEN T. 87 & 88	934.98	
BETWEEN T. 88 & 89	933.87	
BETWEEN T. 89 & 90	932.76	
BETWEEN T. 90 & 91	931.65	
BETWEEN T. 91 & 92	930.54	
BETWEEN T. 92 & 93	929.43	
BETWEEN T. 93 & 94	928.32	
BETWEEN T. 94 & 95	927.21	
BETWEEN T. 95 & 96	926.10	
BETWEEN T. 96 & 97	924.99	
BETWEEN T. 97 & 98	923.88	
BETWEEN T. 98 & 99	922.77	
BETWEEN T. 99 & 100	921.66	
BETWEEN T. 100 & 101	920.55	
BETWEEN T. 101 & 102	919.44	
BETWEEN T. 102 & 103	918.33	
BETWEEN T. 103 & 104	917.22	
BETWEEN T. 104 & 105	916.11	
BETWEEN T. 105 & 106	915.00	
BETWEEN T. 106 & 107	913.89	
BETWEEN T. 107 & 108	912.78	
BETWEEN T. 108 & 109	911.67	
BETWEEN T. 109 & 110	910.56	
BETWEEN T. 110 & 111	909.45	
BETWEEN T. 111 & 112	908.34	
BETWEEN T. 112 & 113	907.23	
BETWEEN T. 113 & 114	906.12	
BETWEEN T. 114 & 115	905.01	
BETWEEN T. 115 & 116	903.90	
BETWEEN T. 116 & 117	902.79	
BETWEEN T. 117 & 118	901.68	
BETWEEN T. 118 & 119	900.57	
BETWEEN T. 119 & 120	899.46	
BETWEEN T. 120 & 121	898.35	
BETWEEN T. 121 & 122	897.24	
BETWEEN T. 122 & 123	896.13	
BETWEEN T. 123 & 124	895.02	
BETWEEN T. 124 & 125	893.91	
BETWEEN T. 125 & 126	892.80	
BETWEEN T. 126 & 127	891.69	
BETWEEN T. 127 & 128	890.58	
BETWEEN T. 128 & 129	889.47	
BETWEEN T. 129 & 130	888.36	
BETWEEN T. 130 & 131	887.25	
BETWEEN T. 131 & 132	886.14	
BETWEEN T. 132 & 133	885.03	
BETWEEN T. 133 & 134	883.92	
BETWEEN T. 134 & 135	882.81	
BETWEEN T. 135 & 136	881.70	
BETWEEN T. 136 & 137	880.59	
BETWEEN T. 137 & 138	879.48	
BETWEEN T. 138 & 139	878.37	
BETWEEN T. 139 & 140	877.26	
BETWEEN T. 140 & 141	876.15	
BETWEEN T. 141 & 142	875.04	
BETWEEN T. 142 & 143	873.93	
BETWEEN T. 143 & 144	872.82	
BETWEEN T. 144 & 145	871.71	
BETWEEN T. 145 & 146	870.60	
BETWEEN T. 146 & 147	869.49	
BETWEEN T. 147 & 148	868.38	
BETWEEN T. 148 & 149	867.27	
BETWEEN T. 149 & 150	866.16	
BETWEEN T. 150 & 151	865.05	
BETWEEN T. 151 & 152	863.94	
BETWEEN T. 152 & 153	862.83	
BETWEEN T. 153 & 154	861.72	
BETWEEN T. 154 & 155	860.61	
BETWEEN T. 155 & 156	859.50	
BETWEEN T. 156 & 157	858.39	
BETWEEN T. 157 & 158	857.28	
BETWEEN T. 158 & 159	856.17	
BETWEEN T. 159 & 160	855.06	
BETWEEN T. 160 & 161	853.95	
BETWEEN T. 161 & 162	852.84	
BETWEEN T. 162 & 163	851.73	
BETWEEN T. 163 & 164	850.62	
BETWEEN T. 164 & 165	849.51	
BETWEEN T. 165 & 166	848.40	
BETWEEN T. 166 & 167	847.29	
BETWEEN T. 167 & 168	846.18	
BETWEEN T. 168 & 169	845.07	
BETWEEN T. 169 & 170	843.96	
BETWEEN T. 170 & 171	842.85	
BETWEEN T. 171 & 172	841.74	
BETWEEN T. 172 & 173	840.63	
BETWEEN T. 173 & 174	839.52	
BETWEEN T. 174 & 175	838.41	
BETWEEN T. 175 & 176	837.30	
BETWEEN T. 176 & 177	836.19	
BETWEEN T. 177 & 178	835.08	
BETWEEN T. 178 & 179	833.97	
BETWEEN T. 179 & 180	832.86	
BETWEEN T. 180 & 181	831.75	
BETWEEN T. 181 & 182	830.64	
BETWEEN T. 182 & 183	829.53	
BETWEEN T. 183 & 184	828.42	
BETWEEN T. 184 & 185	827.31	
BETWEEN T. 185 & 186	826.20	
BETWEEN T. 186 & 187	825.09	
BETWEEN T. 187 & 188	823.98	
BETWEEN T. 188 & 189	822.87	
BETWEEN T. 189 & 190	821.76	
BETWEEN T. 190 & 191	820.65	
BETWEEN T. 191 & 192	819.54	
BETWEEN T. 192 & 193	818.43	
BETWEEN T. 193 & 194	817.32	
BETWEEN T. 194 & 195	816.21	
BETWEEN T. 195 & 196	815.10	
BETWEEN T. 196 & 197	813.99	
BETWEEN T. 197 & 198	812.88	
BETWEEN T. 198 & 199	811.77	
BETWEEN T. 199 & 200	810.66	
BETWEEN T. 200 & 201	809.55	
BETWEEN T. 201 & 202	808.44	
BETWEEN T. 202 & 203	807.33	
BETWEEN T. 203 & 204	806.22	
BETWEEN T. 204 & 205	805.11	
BETWEEN T. 205 & 206	804.00	
BETWEEN T. 206 & 207	802.89	
BETWEEN T. 207 & 208	801.78	
BETWEEN T. 208 & 209	800.67	
BETWEEN T. 209 & 210	799.56	
BETWEEN T. 210 & 211	798.45	
BETWEEN T. 211 & 212	797.34	
BETWEEN T. 212 & 213	796.23	
BETWEEN T. 213 & 214	795.12	
BETWEEN T. 214 & 215	794.01	
BETWEEN T. 215 & 216	792.90	
BETWEEN T. 216 & 217	791.79	
BETWEEN T. 217 & 218	790.68	
BETWEEN T. 218 & 219	789.57	
BETWEEN T. 219 & 220	788.46	
BETWEEN T. 220 & 221	787.35	
BETWEEN T. 221 & 222	786.24	
BETWEEN T. 222 & 223	785.13	
BETWEEN T. 223 & 224	784.02	
BETWEEN T. 224 & 225	782.91	
BETWEEN T. 225 & 226	781.80	
BETWEEN T. 226 & 227	780.69	
BETWEEN T. 227 & 228	779.58	
BETWEEN T. 228 & 229	778.47	
BETWEEN T. 229 & 230	777.36	
BETWEEN T. 230 & 231	776.25	
BETWEEN T. 231 & 232	775.14	
BETWEEN T. 232 & 233	774.03	
BETWEEN T. 233 & 234	772.92	
BETWEEN T. 234 & 235	771.81	
BETWEEN T. 235 & 236	770.70	
BETWEEN T. 236 & 237	769.59	
BETWEEN T. 237 & 238	768.48	
BETWEEN T. 238 & 239	767.37	
BETWEEN T. 239 & 240	766.26	
BETWEEN T. 240 & 241	765.15	
BETWEEN T. 241 & 242	764.04	
BETWEEN T. 242 & 243	762.93	
BETWEEN T. 243 & 244	761.82	
BETWEEN T. 244 & 245	760.71	
BETWEEN T. 245 & 246	759.60	
BETWEEN T. 246 & 247	758.49	
BETWEEN T. 247 & 248	757.38	
BETWEEN T. 248 & 249	756.27	
BETWEEN T. 249 & 250	755.16	
BETWEEN T. 250 & 251	754.05	
BETWEEN T. 251 & 252	752.94	
BETWEEN T. 252 & 253	751.83	
BETWEEN T. 253 & 254	750.72	
BETWEEN T. 254 & 255	749.61	
BETWEEN T. 255 & 256	748.50	
BETWEEN T. 256 & 257	747.39	
BETWEEN T. 257 & 258	746.28	
BETWEEN T. 258 & 259	745.17	
BETWEEN T. 259 & 260	744.06	
BETWEEN T. 260 & 261	742.95	
BETWEEN T. 261 & 262	741.84	
BETWEEN T. 262 & 263	740.73	
BETWEEN T. 263 & 264	739.62	
BETWEEN T. 264 & 265	738.51	
BETWEEN T. 265 & 266	737.40	
BETWEEN T. 266 & 267	736.29	
BETWEEN T. 267 & 268	735.18	
BETWEEN T. 268 & 269	734.07	
BETWEEN T. 269 & 270	732.96	
BETWEEN T. 270 & 271	731.85	
BETWEEN T. 271 & 272	730.74	
BETWEEN T. 272 & 273	729.63	
BETWEEN T. 273 & 274	728.52	
BETWEEN T. 274 & 275	727.41	
BETWEEN T. 275 & 276	726.30	
BETWEEN T. 276 & 277	725.19	
BETWEEN T. 277 & 278	724.08	
BETWEEN T. 278 & 279	722.97	
BETWEEN T. 279 & 280	721.86	
BETWEEN T. 280 & 281	720.75	
BETWEEN T. 281 & 282	719.64	
BETWEEN T. 282 & 283	718.53	
BETWEEN T. 283 & 284	717.42	
BETWEEN T. 284 & 285	716.31	
BETWEEN T. 285 & 286	715.20	
BETWEEN T. 286 & 287	714.09	
BETWEEN T. 287 & 288	712.98	
BETWEEN T. 288 & 289	711.87	
BETWEEN T. 289 & 290	710.76	
BETWEEN T. 290 & 291	709.65	
BETWEEN T. 291 & 292	708.54	
BETWEEN T. 292 & 293	707.43	
BETWEEN T. 293 & 294	706.32	
BETWEEN T. 294 & 295	705.21	
BETWEEN T. 295 & 296	704.10	
BETWEEN T. 296 & 297	702.99	
BETWEEN T. 297 & 298	701.88	
BETWEEN T. 298 & 299	700.77	
BETWEEN T. 299 & 300	699.66	
BETWEEN T. 300 & 301	698.55	
BETWEEN T. 301 & 302	697.44	
BETWEEN T. 302 & 303	696.33	
BETWEEN T. 303 & 304	695.22	
BETWEEN T.		



Tue 17 Mar 1992

U.S. Army Corps of Engineers  
PROJECT PLUMCR: - PLUM CREEK DETENTION DAM  
GDM ESTIMATE-PLUM CREEK

TIME 08:31:20

TITLE PAGE 1

---

PLUM CREEK DETENTION DAM  
WICHITA FALLS, TEXAS  
FEASIBILITY STUDY COST EST.

Designed By:  
Estimated By:

Prepared By: TED MCCLEARY

Date: 03/17/92

M C A C E S G O L D E D I T I O N  
Composer GOLD Copyright (C) 1985, 1988, 1990  
by Building Systems Design, Inc.  
Release 5.01H

SUMMARY REPORTS	SUMMARY PAGE
PROJECT OWNER SUMMARY - LEVEL 1.....	1
PROJECT INDIRECT SUMMARY - LEVEL 1.....	2
PROJECT DIRECT SUMMARY - LEVEL 1.....	3
CONTRACTOR INDIRECT SUMMARY.....	4

DETAILED ESTIMATE	DETAIL PAGE
AA. PRIME.....	1
01. LANDS AND DAMAGES	
D. ADMINISTRATIVE COSTS.....	2
M. LANDS AND DAMAGES.....	3
02. RELOCATIONS	
3. RELOCATIONS.....	4
04. DAMS	
1. MAIN DAM.....	5
2. SPILLWAY.....	8
3. OUTLET WORKS.....	10
06. WILDLIFE FACILITIES	
3. WILDLIFE FACILITIES.....	13
08. ROADS, RAILROADS, AND BRIDGES	
2. ROADS.....	14
30. PLANNING, ENGINEERING, DESIGN	
.....	16
31. CONSTRUCTION MANAGEMENT	
.....	17

BACKUP REPORTS	BACKUP PAGE
CREW BACKUP.....	1

\*\*\* END TABLE OF CONTENTS \*\*\*

Tue 17 Mar 1992

U.S. Army Corps of Engineers  
PROJECT PLUMCR: - PLUM CREEK DETENTION DAM  
GDM ESTIMATE-PLUM CREEK  
\*\* PROJECT OWNER SUMMARY - LEVEL 1 \*\*

TIME 08:31:20

SUMMARY PAGE 1

	QUANTY UOM	CONTRACT	DSN CONT	TOTAL COST	UNIT
01	LANDS AND DAMAGES	257,768	64,442	322,209	
02	RELOCATIONS	30,041	7,510	37,551	
04	DAMS	1,465,065	186,675	1,651,740	
06	WILDLIFE FACILITIES	14,943	3,736	18,678	
08	ROADS, RAILROADS, AND BRIDGES	13,413	1,103	14,516	
30	PLANNING, ENGINEERING, DESIGN	132,000	33,000	165,000	
31	CONSTRUCTION MANAGEMENT	157,000	39,250	196,250	
	PLUM CREEK FEASIBILITY STUDY-GDM	2,070,228	335,716	2,405,944	

LABOR ID: RG0691

EQUIP ID: RG0691

CURRENCY IN DOLLARS

CREW ID: RG0691

UPB ID: RG0691

Tue 17 Mar 1992

U.S. Army Corps of Engineers  
PROJECT PLUMCR: - PLUM CREEK DETENTION DAM  
GDM ESTIMATE-PLUM CREEK  
\*\* PROJECT INDIRECT SUMMARY - LEVEL 1 \*\*

TIME 08:31:20

SUMMARY PAGE 2

	QUANTY	UOM	DIRECT	OVERHEAD	PROFIT	BOND	TOTAL COST	UNIT
01	LANDS AND DAMAGES		257,768	0	0	0	257,768	
02	RELOCATIONS		24,623	2,955	2,462	0	30,041	
04	DAMS		1,319,878	0	131,988	13,199	1,465,065	
06	WILDLIFE FACILITIES		14,943	0	0	0	14,943	
08	ROADS, RAILROADS, AND BRIDGES		12,083	0	1,208	121	13,413	
30	PLANNING, ENGINEERING, DESIGN		132,000	0	0	0	132,000	
31	CONSTRUCTION MANAGEMENT		157,000	0	0	0	157,000	
	PLUM CREEK FEASIBILITY STUDY-GDM		1,918,295	2,955	135,659	13,320	2,070,228	
	DESIGN CONTINGENCY						335,716	
	TOTAL INCL OWNER COSTS						2,405,944	



Tue 17 Mar 1992

U.S. Army Corps of Engineers  
PROJECT PLUMCR: - PLUM CREEK DETENTION DAM  
GDM ESTIMATE-PLUM CREEK  
\*\* PROJECT OWNER SUMMARY - LEVEL 1 \*\*

TIME 08:31:20

SUMMARY PAGE 1

	QUANTY UOM	CONTRACT	DSN CONT	TOTAL COST	UNIT
01	LANDS AND DAMAGES	257,768	64,442	322,209	
02	RELOCATIONS	30,041	7,510	37,551	
04	DAMS	1,465,065	186,675	1,651,740	
06	WILDLIFE FACILITIES	14,943	3,736	18,678	
08	ROADS, RAILROADS, AND BRIDGES	13,413	1,103	14,516	
30	PLANNING, ENGINEERING, DESIGN	132,000	33,000	165,000	
31	CONSTRUCTION MANAGEMENT	157,000	39,250	196,250	
	PLUM CREEK FEASIBILITY STUDY-GDM	2,070,228	335,716	2,405,944	

Tue 17 Mar 1992

U.S. Army Corps of Engineers  
PROJECT PLUMCR: - PLUM CREEK DETENTION DAM  
GDM ESTIMATE-PLUM CREEK  
\*\* PROJECT DIRECT SUMMARY - LEVEL 1 \*\*

TIME:08:31:20

SUMMARY PAGE 3

D	OUTPUT	MANHOURS	LABOR	EQUIPMNT	MATERIAL	TOTAL	CST	UNIT COST
01	LANDS AND DAMAGES	0	0	0	257,768	257,768		
02	RELOCATIONS	341	7,404	1,945	15,274	24,623		
04	DAMS	31,448	387,590	576,127	356,162	1,319,878		
06	WILDLIFE FACILITIES	322	3,285	1,339	10,319	14,943		
08	ROADS, RAILROADS, AND BRIDGE	177	2,116	2,295	7,673	12,083		
30	PLANNING, ENGINEERING, DESIG	0	0	0	132,000	132,000		
31	CONSTRUCTION MANAGEMENT	0	0	0	157,000	157,000		
PLUM CREEK FEASIBILITY STUDY		32,288	400,395	581,706	936,194	1,918,295		
OVERHEAD						2,955		
SUBTOTAL						1,921,250		
HOME OFC						135,659		
SUBTOTAL						2,056,909		
BOND						13,320		
TOTAL INCL INDIRECTS						2,070,228		
DESIGN CONTINGENCY						335,716		
TOTAL INCL OWNER COSTS						2,405,944		

Tue 17 Mar 1992

U.S. Army Corps of Engineers  
PROJECT PLUMCR: - PLUM CREEK DETENTION DAM  
GDM ESTIMATE-PLUM CREEK  
\*\* PROJECT INDIRECT SUMMARY - LEVEL 1 \*\*

TIME 08:31:20

SUMMARY PAGE 2

	QUANTY UOM	DIRECT	OVERHEAD	PROFIT	BOND	TOTAL COST	UNIT
01	LANDS AND DAMAGES	257,768	0	0	0	257,768	
02	RELOCATIONS	24,623	2,955	2,462	0	30,041	
04	DAMS	1,319,878	0	131,988	13,199	1,465,065	
06	WILDLIFE FACILITIES	14,943	0	0	0	14,943	
08	ROADS, RAILROADS, AND BRIDGES	12,083	0	1,208	121	13,413	
30	PLANNING, ENGINEERING, DESIGN	132,000	0	0	0	132,000	
31	CONSTRUCTION MANAGEMENT	157,000	0	0	0	157,000	
	PLUM CREEK FEASIBILITY STUDY-GDM	1,918,295	2,955	135,659	13,320	2,070,228	
	DESIGN CONTINGENCY					335,716	
	TOTAL INCL OWNER COSTS					2,405,944	

Tue 17 Mar 1992

U.S. Army Corps of Engineers  
PROJECT PLUMCR: - PLUM CREEK DETENTION DAM  
GDM ESTIMATE-PLUM CREEK  
\*\* CONTRACTOR INDIRECT SUMMARY \*\*

TIME 08:31:20

SUMMARY PAGE 4

---

	QUANTY UOM	DIRECT	OVERHEAD	PROFIT	BOND	TOTAL COST	UNIT
	NOT IDENTIFIED	14,943				14,943	
AA	PRIME	1,218,079		121,808	12,181	1,352,067	
AA (S)	PRIME	113,883		11,388	1,139	126,410	
AB	SEPERATE SUB-REAL ESTATE	546,768				546,768	
EE	ELECTRICAL SUBCONTRACTOR	24,623	2,955	2,462		30,041	
LA	TURFING SUBCONTRACTOR	74,224	5,938	7,422		87,584	
PC	CONCRETE SUBCONTRACTOR	22,287	1,783	2,229		26,299	

---

Tue 17 Mar 1992

U.S. Army Corps of Engineers  
PROJECT PLUMCR: - PLUM CREEK DETENTION DAM  
GDM ESTIMATE-PLUM CREEK  
\*\* PROJECT DIRECT SUMMARY - LEVEL 1 \*\*

TIME:08:31:20

SUMMARY PAGE 3

D	OUTPUT	MANHOURS	LABOR	EQUIPMNT	MATERIAL	TOTAL	CST	UNIT	COST
01	LANDS AND DAMAGES	0	0	0	257,768	257,768			
02	RELOCATIONS	341	7,404	1,945	15,274	24,623			
04	DAMS	31,448	387,590	576,127	356,162	1,319,878			
06	WILDLIFE FACILITIES	322	3,285	1,339	10,319	14,943			
08	ROADS, RAILROADS, AND BRIDGE	177	2,116	2,295	7,673	12,083			
30	PLANNING, ENGINEERING, DESIG	0	0	0	132,000	132,000			
31	CONSTRUCTION MANAGEMENT	0	0	0	157,000	157,000			
	PLUM CREEK FEASIBILITY STUDY	32,288	400,395	581,706	936,194	1,918,295			
	OVERHEAD					2,955			
	SUBTOTAL					1,921,250			
	HOME OFC					135,659			
	SUBTOTAL					2,056,909			
	BOND					13,320			
	TOTAL INCL INDIRECTS					2,070,228			
	DESIGN CONTINGENCY					335,716			
	TOTAL INCL OWNER COSTS					2,405,944			

Tue 17 Mar 1992

U.S. Army Corps of Engineers  
PROJECT PLUMCR: - PLUM CREEK DETENTION DAM  
GDM ESTIMATE-PLUM CREEK

TIME 08:31:20

LED ESTIMATE

DETAIL PAGE 1

-----

O.AA. PRIME	D	OUTPUT	MANHOURS	LABOR	EQUIPMNT	MATERIAL TOTAL CST UNIT COST
-------------	---	--------	----------	-------	----------	------------------------------

-----

LABOR ID: RG0691

EQUIP ID: RG0691

CURRENCY IN DOLLARS

CREW ID: RG0691

UPB ID: RG0691

Tue 17 Mar 1992

U.S. Army Corps of Engineers  
PROJECT PLUMCR: - PLUM CREEK DETENTION DAM  
GDM ESTIMATE-PLUM CREEK  
\*\* CONTRACTOR INDIRECT SUMMARY \*\*

TIME 08:31:20

SUMMARY PAGE 4

---

	QUANTY	UOM	DIRECT	OVERHEAD	PROFIT	BOND	TOTAL COST	UNIT
		NOT IDENTIFIED	14,943				14,943	
AA		PRIME	1,218,079		121,808	12,181	1,352,067	
AA (S)		PRIME	113,883		11,388	1,139	126,410	
AB		SEPERATE SUB-REAL ESTATE	546,768				546,768	
EE		ELECTRICAL SUBCONTRACTOR	24,623	2,955	2,462		30,041	
LA		TURFING SUBCONTRACTOR	74,224	5,938	7,422		87,584	
PC		CONCRETE SUBCONTRACTOR	22,287	1,783	2,229		26,299	

Tue 17 Mar 1992

U.S. Army Corps of Engineers  
 PROJECT PLUMCR: - PLUM CREEK DETENTION DAM  
 GDM ESTIMATE-PLUM CREEK  
 01. LANDS AND DAMAGES

TIME 08:31:20

LED ESTIMATE

DETAIL PAGE 2

01. D. ADMINISTRATIVE COSTS	D	OUTPUT	MANHOURS	LABOR	EQUIPMNT	MATERIAL	TOTAL	CST	UNIT COST
01. LANDS AND DAMAGES									
01. D. 1. D. .. ADMINISTRATIVE COSTS									
CONTINGENCY OF 25% PER REAL ESTATE DIVISION-UNCERTAINTY OF LAND COSTS, TITLE OWNERSHIP, AND PROJECT NEEDS.									
ATTORNEY OPINION			0.00	0.00	0.00	400.00	400.00		
16.00 EA		0.00	0	0	0	6,400	6,400	400.00	
REVIEW FOR COMPLIANCE			0.00	0.00	0.00	100.00	100.00		
16.00 EA		0.00	0	0	0	1,600	1,600	100.00	
MAPPING,SURVEY,TRACT OWNERSHIP			0.00	0.00	0.00	1500.00	1500.00		
16.00 EA		0.00	0	0	0	24,000	24,000	1500.00	
REVIEW FOR COMPLIANCE			0.00	0.00	0.00	500.00	500.00		
16.00 EA		0.00	0	0	0	8,000	8,000	500.00	
TITLE EVIDENCE DOCUMENTS			0.00	0.00	0.00	500.00	500.00		
16.00 EA		0.00	0	0	0	8,000	8,000	500.00	
REVIEW FOR COMPLIANCE			0.00	0.00	0.00	300.00	300.00		
16.00 EA		0.00	0	0	0	4,800	4,800	300.00	
NEGOTIATING AND CLOSING COSTS			0.00	0.00	0.00	1500.00	1500.00		
16.00 EA		0.00	0	0	0	24,000	24,000	1500.00	
REVIEW FOR COMPLIANCE			0.00	0.00	0.00	500.00	500.00		
16.00 EA		0.00	0	0	0	8,000	8,000	500.00	
PREPARE APPRAISALS			0.00	0.00	0.00	1300.00	1300.00		
16.00 EA		0.00	0	0	0	20,800	20,800	1300.00	
REVIEW FOR COMPLIANCE			0.00	0.00	0.00	400.00	400.00		
16.00 EA		0.00	0	0	0	6,400	6,400	400.00	
ADMINISTRATIVE COSTS			0	0	0	112,000	112,000		

LABOR ID: RG0691

EQUIP ID: RG0691

CURRENCY IN DOLLARS

CREW ID: RG0691

UPB ID: RG0691



Tue 17 Mar 1992

U.S. Army Corps of Engineers  
PROJECT PLUMCR: - PLUM CREEK DETENTION DAM  
GDM ESTIMATE-PLUM CREEK

TIME 08:31:20

LED ESTIMATE

DETAIL PAGE 1

-----  
O.AA. PRIME                    D        OUTPUT    MANHOURS        LABOR        EQUIPMNT        MATERIAL TOTAL CST UNIT COST  
-----

LABOR ID: RG0691

EQUIP ID: RG0691

CURRENCY IN DOLLARS

CREW ID: RG0691    UPB ID: RG0691

Tue 17 Mar 1992

U.S. Army Corps of Engineers  
 PROJECT PLUMCR: - PLUM CREEK DETENTION DAM  
 GDM ESTIMATE-PLUM CREEK  
 01. LANDS AND DAMAGES

TIME 08:31:20

LED ESTIMATE

DETAIL PAGE 3

01. M. LANDS AND DAMAGES	D	OUTPUT	MANHOURS	LABOR	EQUIPMNT	MATERIAL	TOTAL	CST	UNIT COST
01. M..3. . . . LANDS AND DAMAGES									
CONTINGENCY OF 25% PER REAL ESTATE DIVISION-UNCERTAINTY OF LAND COSTS, TITLE OWNERSHIP, AND PROJECT NEEDS.									
DAMSITE, SPILLWAY, CHANNEL FEE			0.00	0.00	0.00	365.00	365.00		
52.40 ACR		0.00	0	0	0	19,126	19,126	365.00	
WILDLIFE MITIGATION FEE			0.00	0.00	0.00	365.00	365.00		
24.00 ACR		0.00	0	0	0	8,760	8,760	365.00	
PERPETUAL FLOWAGE EASEMENT			0.00	0.00	0.00	294.00	294.00		
262.50 ACR		0.00	0	0	0	77,175	77,175	294.00	
FLOWAGE/BORROW EASEMENT			0.00	0.00	0.00	325.00	325.00		
51.50 ACR		0.00	0	0	0	16,738	16,738	325.00	
SEVERANCE			0.00	0.00	0.00	23319.00	23319.00		
1.00 LS		0.00	0	0	0	23,319	23,319	23319.00	
PERPETUAL ROAD EASEMENT			0.00	0.00	0.00	500.00	500.00		
1.30 ACR		0.00	0	0	0	650	650	500.00	
LANDS AND DAMAGES			0	0	0	145,768	145,768		

Tue 17 Mar 1992

U.S. Army Corps of Engineers  
PROJECT PLUMCR: - PLUM CREEK DETENTION DAM  
GOM ESTIMATE-PLUM CREEK  
02. RELOCATIONS

TIME 08:31:20

LED ESTIMATE

DETAIL PAGE 4

02. 3. RELOCATIONS	D	OUTPUT	MANHOURS	LABOR	EQUIPMNT	MATERIAL	TOTAL	CST	UNIT	COST
--------------------	---	--------	----------	-------	----------	----------	-------	-----	------	------

02. RELOCATIONS

02. 3. 2. 2. .. UTILITIES

CONTINGENCY OF 25%-PRELIMINARY DATA ONLY AVAILABLE-NO DESIGN.

[16120 3410 Galv Stl Interlocked Armor Cable]

CONDUCTOR CABLE			0.29	6.18	1.67	10.61	18.46			
550.00 LF EELEJ		17.50	157	3,400	920	5,836	10,156			18.46

[16413 3200 Head Guy - 50 Ft (15M) Span]

GUY			8.64	186.85	50.55	47.35	284.75			
2.00 EA EELEJ		0.58	17	374	101	95	569			284.75

[16413 4200 Suspension Insulator W/Clevis And Strain Clamp]

INSULATORS			3.14	68.04	18.41	83.53	169.98			
20.00 EA EELEJ		1.59	63	1,361	368	1,671	3,400			169.98

[16413 8100 Round Tapered Pole]

c. POLE			13.97	302.20	81.76	1218.98	1602.93			
5.00 EA EELEJ		0.36	70	1,511	409	6,095	8,015			1602.93

[16413 8400 Arms With Baseplates And Endplates]

CLEAT			5.00	108.19	29.27	297.51	434.96			
5.00 EA EELEJ		1.00	25	541	146	1,488	2,175			434.96

[16452 1000 10 Ft Length]

GROUND ROD			1.85	43.54	0.23	18.11	61.88			
5.00 EA EELEB		1.35	9	218	1	91	309			61.88

UTILITIES			341	7,404	1,945	15,274	24,623			
-----------	--	--	-----	-------	-------	--------	--------	--	--	--

Tue 17 Mar 1992

U.S. Army Corps of Engineers  
PROJECT PLUMCR: - PLUM CREEK DETENTION DAM  
GDM ESTIMATE-PLUM CREEK  
01. LANDS AND DAMAGES

TIME 08:31:20

LED ESTIMATE

DETAIL PAGE 3

01. M. LANDS AND DAMAGES	D	OUTPUT	MANHOURS	LABOR	EQUIPMNT	MATERIAL	TOTAL	CST	UNIT	COST
01. M..3. . . . LANDS AND DAMAGES CONTINGENCY OF 25% PER REAL ESTATE DIVISION-UNCERTAINTY OF LAND COSTS, TITLE OWNERSHIP, AND PROJECT NEEDS.										
DAMSITE, SPILLWAY, CHANNEL FEE			0.00	0.00	0.00	365.00	365.00			
52.40 ACR		0.00	0	0	0	19,126	19,126			365.00
WILDLIFE MITIGATION FEE			0.00	0.00	0.00	365.00	365.00			
24.00 ACR		0.00	0	0	0	8,760	8,760			365.00
PERPETUAL FLOWAGE EASEMENT			0.00	0.00	0.00	294.00	294.00			
262.50 ACR		0.00	0	0	0	77,175	77,175			294.00
FLOWAGE/BORROW EASEMENT			0.00	0.00	0.00	325.00	325.00			
51.50 ACR		0.00	0	0	0	16,738	16,738			325.00
SEVERANCE			0.00	0.00	0.00	23319.00	23319.00			
1.00 LS		0.00	0	0	0	23,319	23,319			23319.00
PERPETUAL ROAD EASEMENT			0.00	0.00	0.00	500.00	500.00			
1.30 ACR		0.00	0	0	0	650	650			500.00
LANDS AND DAMAGES			0	0	0	145,768	145,768			

04. 1. MAIN DAM	D	OUTPUT	MANHOURS	LABOR	EQUIPMNT	MATERIAL	TOTAL	CST	UNIT COST
04. DAMS									
04. 1. . . . 6. EARTHWORK									
CONTINGENCY OF 15%-BORROW LOCATIONS UNKNOWN-SITE CONDITIONS UNKNOWN.									
[02212 1000 Basic Cost Items]									
8 IN. COMPACTION-RANDOM FILL			0.00	0.08	0.27	0.00	0.35		
47100.00 CY COOTK		327.00	180	3,860	12,661	0	16,521		0.35
8 IN. COMPACTION-IMP. FILL			0.00	0.08	0.27	0.00	0.35		
116700.00 CY COOTK		327.00	446	9,565	31,370	0	40,935		0.35
8 IN. COMPACTION-IMP. BORROW			0.00	0.08	0.27	0.00	0.35		
125700.00 CY COOTK		327.00	481	10,303	33,789	0	44,092		0.35
[02212 4100 Optimum Moisture Is 10 Pct Natural Moisture Is]									
COMPACTION WATER-RANDOM FILL			0.02	0.22	0.31	0.19	0.72		
47100.00 CY COFWI		86.00	958	10,402	14,445	8,949	33,796		0.72
COMPACTION WATER-IMP. FILL			0.02	0.22	0.31	0.19	0.72		
166700.00 CY COFWI		86.00	3,392	36,816	51,125	31,673	119,614		0.72
COMPACTION WATER-IMP. BORROW			0.02	0.22	0.31	0.19	0.72		
125700.00 CY COFWI		86.00	2,558	27,761	38,550	23,883	90,195		0.72
[02221 5000 Backfill Trenches - W/O Compaction]									
DISCING AND SHAPING-RANDOM FILL			0.02	0.28	0.31	0.00	0.59		
47100.00 CY CODLB		70.00	1,009	13,227	14,648	0	27,875		0.59
DISCING AND SHAPING-IMP. FILL			0.02	0.28	0.31	0.00	0.59		
116700.00 CY CODLB		70.00	2,501	32,774	36,294	0	69,067		0.59
DISCING AND SHAPING-IMP. BORROW			0.02	0.28	0.31	0.00	0.59		
125700.00 CY CODLB		70.00	2,694	35,301	39,093	0	74,394		0.59
[02225 4230 Dozer W/Blade, 120Hp, (D-5H)]									
EXCAVATION-INSPECTION TRENCH			0.06	0.64	0.99	0.00	1.63		
10200.00 CY XXQNB		30.00	595	6,530	10,101	0	16,631		1.63
[02225 4350 Dozer W/U-Blade, 215Hp, (D-7G)]									
STRIP AND STOCKPILE TOPSOIL			0.02	0.26	0.79	0.00	1.04		
7200.00 CY XXQND		75.00	168	1,844	5,673	0	7,516		1.04
[02226 2300 Sp Scraper Cap. 16 Bcy (12 Bm3) Scraper]									

04. 1. MAIN DAM	D	OUTPUT	MANHOURS	LABOR	EQUIPMNT	MATERIAL	TOTAL	CST	UNIT COST
-----------------	---	--------	----------	-------	----------	----------	-------	-----	-----------

HAUL FROM BORROW-IMP. FILL			0.01	0.20	0.76	0.00	0.96		
125700.00 CY CODSB		112.50	1,866	25,399	95,851	0	121,250		0.96
EARTHWORK			16,848	213,782	383,599	64,505	661,886		

04. 1. . . . B. CARE OF WATER  
 CONTINGENCY OF 25%-SITE CONDITIONS UNKNOWN-PRELIMINARY DATA-NO PLANS.

CARE AND CONTROL OF WATER			0.00	0.00	0.00	50000.00	50000.00		
1.00 LS		0.00	0	0	0	50,000	50,000		50000.00
CARE OF WATER			0	0	0	50,000	50,000		

04. 1. . . . C. ACCESS ROADS  
 CONTINGENCY OF 5%-SOURCES OF MATERIALS UNKNOWN.

[02610 1000 Lime Stabilized Subgrade Based On Existing Soil]

Layer Lime Stabilization			0.04	0.49	0.52	1.00	2.00		
52800.00 SY COFCJ		150.00	2,112	25,686	27,349	52,800	105,835		2.00

[02612 1200 Special Bituminous Or Macadam Stone Bases See]

T.B.S.C.			0.07	0.92	0.74	23.00	24.65		
440.00 CY COKBF		81.75	32	403	325	10,120	10,848		24.65
ACCESS ROADS			2,144	26,089	27,674	62,920	116,682		

04. 1. . . . F. SEEPAGE CONTROL  
 CONTINGENCY OF 5%-MATERIAL SOURCES UNKNOWN.

[02221 1300 By Hydraulic Excav. - 1 Cy Capacity]

TOE TRENCH EXCAVATION			0.02	0.30	0.39	0.00	0.69		
1400.00 CY CODED		104.00	27	422	551	0	973		0.69

[02221 7000 Compaction In 6 In (15Cm) Layers]

COMPACTION OF TOE TRENCH SAND			0.07	0.75	0.06	0.00	0.81		
7500.00 CY CLACC		40.50	556	5,646	434	0	6,081		0.81

[02221 8000 Backfill Trenches-Sand Bedding W/D Compaction]

TOE TRENCH FILTER SAND			0.03	0.41	0.46	13.60	14.47		
7500.00 CY CODLB		47.50	237	3,104	3,437	102,000	108,541		14.47

.1 2100 Perforated Pvc Pipe]

Tue 17 Mar 1992

U.S. Army Corps of Engineers  
PROJECT PLUMCR: - PLUM CREEK DETENTION DAM  
GDM ESTIMATE-PLUM CREEK  
04. DAMS

TIME 08:31:20

FILED ESTIMATE

DETAIL PAGE 5

04. 1. MAIN DAM	D	OUTPUT	MANHOURS	LABOR	EQUIPMNT	MATERIAL	TOTAL CST	UNIT COST
-----------------	---	--------	----------	-------	----------	----------	-----------	-----------

04. DAMS

04. 1. . . . 6. EARTHWORK

CONTINGENCY OF 15%-BORROW LOCATIONS UNKNOWN-SITE CONDITIONS UNKNOWN.

[02212 1000 Basic Cost Items]

8 IN. COMPACTION-RANDOM FILL			0.00	0.08	0.27	0.00	0.35	
47100.00 CY CODTK	327.00	180	3,860	12,661	0	16,521	0.35	
8 IN. COMPACTION-IMP. FILL			0.00	0.08	0.27	0.00	0.35	
116700.00 CY CODTK	327.00	446	9,565	31,370	0	40,935	0.35	
8 IN. COMPACTION-IMP. BORROW			0.00	0.08	0.27	0.00	0.35	
125700.00 CY CODTK	327.00	481	10,303	33,789	0	44,092	0.35	

[02212 4100 Optimum Moisture Is 10 Pct Natural Moisture Is]

COMPACTION WATER-RANDOM FILL			0.02	0.22	0.31	0.19	0.72	
47100.00 CY COFWI	86.00	958	10,402	14,445	8,949	33,796	0.72	
COMPACTION WATER-IMP. FILL			0.02	0.22	0.31	0.19	0.72	
166700.00 CY COFWI	86.00	3,392	36,816	51,125	31,673	119,614	0.72	
COMPACTION WATER-IMP. BORROW			0.02	0.22	0.31	0.19	0.72	
125700.00 CY COFWI	86.00	2,558	27,761	38,550	23,883	90,195	0.72	

[02221 5000 Backfill Trenches - W/O Compaction]

DISCING AND SHAPING-RANDOM FILL			0.02	0.28	0.31	0.00	0.59	
47100.00 CY CODLB	70.00	1,009	13,227	14,648	0	27,875	0.59	
DISCING AND SHAPING-IMP. FILL			0.02	0.28	0.31	0.00	0.59	
116700.00 CY CODLB	70.00	2,501	32,774	36,294	0	69,067	0.59	
DISCING AND SHAPING-IMP. BORROW			0.02	0.28	0.31	0.00	0.59	
125700.00 CY CODLB	70.00	2,694	35,301	39,093	0	74,394	0.59	

[02225 4230 Dozer W/Blade, 120Hp, (D-5H)]

EXCAVATION-INSPECTION TRENCH			0.06	0.64	0.99	0.00	1.63	
10200.00 CY XXQNB	30.00	595	6,530	10,101	0	16,631	1.63	

[02225 4350 Dozer W/U-Blade, 215Hp, (D-7G)]

STRIP AND STOCKPILE TOPSOIL			0.02	0.26	0.79	0.00	1.04	
7200.00 CY XXQND	75.00	168	1,844	5,673	0	7,516	1.04	

[02226 2300 Sp Scraper Cap. 16 Bcy (12 Bm3) Scraper]

Tue 17 Mar 1992

U.S. Army Corps of Engineers  
PROJECT PLUMCR: - PLUM CREEK DETENTION DAM  
GDM ESTIMATE-PLUM CREEK  
04. DAMS

TIME 08:31:20

LED ESTIMATE

DETAIL PAGE 7

04. 1. MAIN DAM	D	OUTPUT	MANHOURS	LABOR	EQUIPMNT	MATERIAL	TOTAL	CST	UNIT	COST
8 In Dia PERFORATED PVC			0.13	1.60	1.09	1.75	4.44			
2550.00 LF CODEX		38.75	329	4,069	2,780	4,463	11,311			4.44
[02512 0000 Underlab Drainage]										
Plastic Filter Fabric For Under-			1.07	10.84	0.23	7.00	18.07			
26.00 CSF ULABF		2.81	28	282	6	182	470			18.07
SEEPAGE CONTROL			1,176	13,523	7,208	106,645	127,376			

04. 1. . . . R. ASSOCIATED GENERAL ITEMS  
CONTINGENCY OF 10%-VARIETY OF SEED AND APPLICATION RATES NOT KNOWN.

[02810 1000 Mechanical Seeding]										
SEED, FERTILIZER, MULCH			32.89	391.92	43.03	1770.00	2204.95			
16.00 ACR ULABE		0.04	526	6,271	688	28,320	35,279			2204.95
[02820 2000 Spreading Top Soil From Stock Pile]										
JIL FROM STOCKPILE			0.05	0.66	0.50	0.00	1.15			
10000.00 CY CODLA		60.00	500	6,553	4,997	0	11,550			1.15
[02820 3000 Furnish And Place Imported Top Soil]										
TOPSOIL FROM BORROW			0.08	0.98	0.75	0.00	1.73			
4800.00 CY CODLA		40.00	360	4,718	3,598	0	8,316			1.73
ASSOCIATED GENERAL ITEMS			1,386	17,542	9,283	28,320	55,144			



Tue 17 Mar 1992

U.S. Army Corps of Engineers  
PROJECT PLUMCR: - PLUM CREEK DETENTION DAM  
GDM ESTIMATE-PLUM CREEK  
04. DAMS

TIME 08:31:20

LED ESTIMATE

DETAIL PAGE 8

04. 2. SPILLWAY	D	OUTPUT	MANHOURS	LABOR	EQUIPMNT	MATERIAL	TOTAL	CST	UNIT COST
04. 2. .... 2. CONCRETE CONTINGENCY OF 25%-AMOUNT OF CURING, FORMING, FINISHING, MIX DESIGN, ETC. UNKNOWN.									
[03210 1000 Footings And Slabs]									
REINFORCING			12.78	212.63	2.96	440.00	655.60		
8.25 TON SIWRC		0.31	105	1,754	24	3,630	5,409		655.60
[03311 1250 Elevated Stairs]									
CONCRETE			3.27	40.95	24.57	47.00	112.52		
150.00 CY ALABG		2.75	491	6,142	3,686	7,050	16,879		112.52
CONCRETE			596	7,897	3,711	10,680	22,287		
CONCRETE SUBCONTRACTOR				1,421	668	1,922	4,012		
			596	9,318	4,378	12,602	26,299		
04. 2. .... D. EARTHWORK FOR STRUCTURES CONTINGENCY OF 25%-TYPE OF MATERIAL, DEPTH OF CUT, NEED FOR SHORING, ARE ALL UNKNOWN.									
[02226 1000 Excavation By Dozer Moved 150 Ft (45M) And]									
SILL EXCAVATION			0.05	0.71	0.78	0.00	1.50		
180.00 CY CODTC		25.00	9	128	141	0	269		1.50
EARTHWORK FOR STRUCTURES			9	128	141	0	269		
04. 2. .... R. ASSOCIATED GENERAL ITEMS CONTINGENCY OF 10%-HAUL DISTANCE AND ROUTES UNKNOWN.									
[02221 8000 Backfill Trenches-Sand Bedding W/O Compaction]									
SAND BEDDING			0.03	0.41	0.46	13.60	14.47		
30.00 CY CODLB		47.50	1	12	14	408	434		14.47
[02225 4230 Dozer W/Blade, 120Hp, (D-5H)]									
EXCAVATION-COMMON			0.06	0.64	0.99	0.00	1.63		
122600.00 CY XXQNB		30.00	7,152	78,487	121,415	0	199,902		1.63
[02225 4350 Dozer W/U-Blade, 215Hp, (D-7G)]									
TRIP AND STOCKPILE TOPSOIL			0.02	0.26	0.79	0.00	1.04		
5600.00 CY XXQND		75.00	131	1,434	4,412	0	5,846		1.04
[02810 1000 Mechanical Seeding]									

LABOR ID: RG0691 EQUIP ID: RG0691

CURRENCY IN DOLLARS

CREW ID: RG0691 UPB ID: RG0691

Tue 17 Mar 1992

U.S. Army Corps of Engineers  
PROJECT PLUMCR: - PLUM CREEK DETENTION DAM  
GDM ESTIMATE-PLUM CREEK  
04. DAMS

TIME 08:31:20

LED ESTIMATE

DETAIL PAGE 7

04. 1. MAIN DAM	D	OUTPUT	MANHOURS	LABOR	EQUIPMNT	MATERIAL	TOTAL	CST	UNIT COST
8 In Dia PERFORATED PVC 2550.00 LF CODEX		38.75	0.13 329	1.60 4,069	1.09 2,780	1.75 4,463	4.44 11,311		4.44
[02512 0000 Underslab Drainage]									
Plastic Filter Fabric For Under- 26.00 CSF ULABF		2.81	1.07 28	10.84 282	0.23 6	7.00 182	18.07 470		18.07
SEEPAGE CONTROL			1,176	13,523	7,208	106,645	127,376		
04. 1. . . . R. ASSOCIATED GENERAL ITEMS CONTINGENCY OF 10%-VARIETY OF SEED AND APPLICATION RATES NOT KNOWN.									
[02810 1000 Mechanical Seeding]									
SEED, FERTILIZER, MULCH 16.00 ACR ULABE		0.04	32.89 526	391.92 6,271	43.03 688	1770.00 28,320	2204.95 35,279		2204.95
[02820 2000 Spreading Top Soil From Stock Pile]									
JIL FROM STOCKPILE 10000.00 CY CODLA		60.00	0.05 500	0.66 6,553	0.50 4,997	0.00 0	1.15 11,550		1.15
[02820 3000 Furnish And Place Imported Top Soil]									
TOPSOIL FROM BORROW 4800.00 CY CODLA		40.00	0.08 360	0.98 4,718	0.75 3,598	0.00 0	1.73 8,316		1.73
ASSOCIATED GENERAL ITEMS			1,386	17,542	9,283	28,320	55,144		

LABOR ID: RG0691

EQUIP ID: RG0691

CURRENCY IN DOLLARS

CREW ID: RG0691

UPB ID: RG0691

Tue 17 Mar 1992

U.S. Army Corps of Engineers  
PROJECT PLUMCR: - PLUM CREEK DETENTION DAM  
GDM ESTIMATE-PLUM CREEK  
04. DAMS

TIME 08:31:20

ED ESTIMATE

DETAIL PAGE 9

04. 2. SPILLWAY	D	OUTPUT	MANHOURS	LABOR	EQUIPMNT	MATERIAL	TOTAL	CST	UNIT	COST
SEED, FERTILIZER, MULCH			32.89	391.92	43.03	1770.00				2204.95
7.00 ACR ULABE		0.04	230	2,743	301	12,390				15,435 2204.95
[02820 2000 Spreading Top Soil From Stock Pile]										
TOPSOIL FROM STOCKPILE			0.05	0.66	0.50	0.00				1.15
5800.00 CY CODLA		60.00	290	3,801	2,898	0				6,699 1.15
ASSOCIATED GENERAL ITEMS			7,804	86,477	129,040	12,798				228,315

LABOR ID: RG0691

EQUIP ID: RG0691

CURRENCY IN DOLLARS

CREW ID: RG0691

UPB ID: RG0691

Tue 17 Mar 1992

U.S. Army Corps of Engineers  
 PROJECT PLUMCR: - PLUM CREEK DETENTION DAM  
 GDM ESTIMATE-PLUM CREEK  
 04. DAMS

TIME 08:31:20

TILED ESTIMATE

DETAIL PAGE 10

04. 3. OUTLET WORKS	D	OUTPUT	MANHOURS	LABOR	EQUIPMNT	MATERIAL	TOTAL	CST	UNIT	COST
04. 3. . . . . 1. APPROACH AND OUTLET CHANNELS										
CONTINGENCY OF 15%-HAUL DISTANCE AND ROUTE UNKNOWN.										
		0.00	0	0	0	0	0	0	0.00	0.00
[02226 1000		Excavation By Dozer Moved 150 Ft (45M) And]								
APPROACH CHANNEL EXCAVATION			0.05	0.71	0.78	0.00	1.50			
1100.00 CY CODTC		25.00	55	784	862	0	1,646			1.50
OUTLET CHANNEL EXCAVATION			0.05	0.71	0.78	0.00	1.50			
2500.00 CY CODTC		25.00	125	1,783	1,958	0	3,741			1.50
APPROACH AND OUTLET CHANNELS			180	2,567	2,820	0	5,386			
04. 3. . . . . 4. INLET STRUCTURE										
CONTINGENCY OF 25%-NO DESIGN, NO SITE VISIT, NO QUANTITIES.										
[021 5000		Backfill Trenches - W/O Compaction]								
AND BACKFILL			0.31	3.16	0.04	0.00	3.20			
100.00 CY ULABA		4.00	31	316	4	0	320			3.20
[02452 1000		Reinforced Conc. Pipe Class 3 Without Gaskets]								
30 In CONCRETE PIPE			0.56	6.08	3.22	16.25	25.56			
175.00 LF UOEHC		10.63	99	1,065	564	2,844	4,472			25.56
[02452 5000		Precast End Sections]								
GRATE			4.80	51.72	9.56	685.00	746.27			
1.00 EA CODEK		1.25	5	52	10	685	746			746.27
[02520 2110		30 Degree Skewed Wingwall, Sized By Drain Pipe]								
30 In. Pipe HEADWALL			40.00	524.70	22.03	250.00	796.74			
2.00 EA ALABM		0.15	80	1,049	44	500	1,593			796.74
[03363 0000		2nd Pour Concrete]								
CONCRETE CRADLE			3.20	35.79	2.83	50.88	89.50			
45.00 CY ALABE		1.88	144	1,611	127	2,290	4,027			89.50
INLET STRUCTURE			359	4,092	749	6,318	11,159			

LABOR ID: RG0691

EQUIP ID: RG0691

CURRENCY IN DOLLARS

CREW ID: RG0691

UPB ID: RG0691

Tue 17 Mar 1992

U.S. Army Corps of Engineers  
PROJECT PLUMCR: - PLUM CREEK DETENTION DAM  
GDM ESTIMATE-PLUM CREEK  
04. DAMS

TIME .08:31:20

ED ESTIMATE

DETAIL PAGE 9

04. 2. SPILLWAY	D	OUTPUT	MANHOURS	LABOR	EQUIPMNT	MATERIAL	TOTAL CST	UNIT COST
SEED, FERTILIZER, MULCH			32.89	391.92	43.03	1770.00	2204.95	
7.00 ACR ULABE		0.04	230	2,743	301	12,390	15,435	2204.95
[02820 2000 Spreading Top Soil From Stock Pile]								
TOPSOIL FROM STOCKPILE			0.05	0.66	0.50	0.00	1.15	
5800.00 CY CODLA		60.00	290	3,801	2,898	0	6,699	1.15
ASSOCIATED GENERAL ITEMS			7,804	86,477	129,040	12,798	228,315	

LABOR ID: RG0691

EQUIP ID: RG0691

CURRENCY IN DOLLARS

CREW ID: RG0691

UPB ID: RG0691

04. 3. OUTLET WORKS		D	OUTPUT	MANHOURS	LABOR	EQUIPMNT	MATERIAL	TOTAL	CST	UNIT	COST
04. 3. .... D. EARTHWORK FOR STRUCTURES CONTINGENCY OF 15%-SITE CONDITIONS UNKNOWN.											
	0.00		0.00	0	0	0	0	0	0	0.00	0.00
	0.00		0.00	0	0	0	0	0	0	0.00	0.00
[02221 5000 Backfill Trenches - W/O Compaction]											
EXC. AND BACKFILL				0.31	3.16	0.04	0.00	3.20			
360.00 CY ULABA		4.00	113	1,136	16	0	1,152	3.20			3.20
EARTHWORK FOR STRUCTURES			113	1,136	16	0	1,152				
04. 3. .... R. ASSOCIATED GENERAL ITEMS CONTINGENCY OF 15%-NO DESIGN											
	0.00		0.00	0	0	0	0	0	0	0.00	0.00
[02226 1000 Excavation By Dozer Moved 150 Ft (45M) And]											
DIVERSION CHANNEL EXCAVATION				0.05	0.71	0.78	0.00	1.50			
8500.00 CY CODTC		25.00	425	6,061	6,657	0	12,718	1.50			1.50
[02261 1000 Random - Filter Stone Dumped From Trucks -]											
RIP RAP-18 INCH				0.51	6.34	4.33	12.50	23.17			
170.00 CY CODEX		9.75	87	1,078	736	2,125	3,940	23.17			23.17
BEDDING MATERIAL				0.13	1.40	1.04	13.00	15.44			
80.00 CY COETF		32.00	10	112	84	1,040	1,235	15.44			15.44
[02264 1000 Vinyl Mats]											
FILTER CLOTH				0.01	0.09	0.00	5.50	5.59			
300.00 SY ULABB		287.50	3	26	0	1,650	1,677	5.59			5.59
[02810 1000 Mechanical Seeding]											
TURFING-APPROACH CHANNEL				32.89	332.14	36.47	1500.00	1868.60			
0.50 ACR ULABE		0.04	16	166	18	750	934	1868.60			1868.60
TURFING-OUTLET CHANNEL				32.89	332.14	36.47	1500.00	1868.60			
0.50 ACR ULABE		0.04	16	166	18	750	934	1868.60			1868.60
ING-DIVERSION CHANNEL				32.89	332.14	36.47	1500.00	1868.60			
2.60 ACR ULABE		0.04	86	864	95	3,900	4,858	1868.60			1868.60
[02820 2000 Spreading Top Soil From Stock Pile]											
LABOR ID: RG0691	EQUIP ID: RG0691		CURRENCY IN DOLLARS			CREW ID: RG0691		UPB ID: RG0691			

Tue 17 Mar 1992

U.S. Army Corps of Engineers  
PROJECT PLUMCR: - PLUM CREEK DETENTION DAM  
GDM ESTIMATE-PLUM CREEK  
04. DAMS

TIME 08:31:20

LED ESTIMATE

DETAIL PAGE 12

04. 3. OUTLET WORKS		D	OUTPUT	MANHOURS	LABOR	EQUIPMNT	MATERIAL	TOTAL	CST	UNIT COST
TOPSOIL-APPROACH CHANNEL				0.10	1.31	1.00	0.00	2.31		
150.00 CY	CODLA		30.00	15	197	150	0	346		2.31
TOPSOIL-OUTLET CHANNEL				0.10	1.31	1.00	0.00	2.31		
350.00 CY	CODLA		30.00	35	459	350	0	808		2.31
TOPSOIL-DIVERSION CHANNEL				0.10	1.31	1.00	0.00	2.31		
1400.00 CY	CODLA		30.00	140	1,835	1,399	0	3,234		2.31
ASSOCIATED GENERAL ITEMS				833	10,963	9,508	10,215	30,685		
TURFING SUBCONTRACTOR					1,973	1,711	1,839	5,523		
				833	12,936	11,219	12,054	36,209		

Tue 17 Mar 1992

U.S. Army Corps of Engineers  
PROJECT PLUMCR: - PLUM CREEK DETENTION DAM  
GDM ESTIMATE-PLUM CREEK  
06. WILDLIFE FACILITIES

TIME 08:31:20

LED ESTIMATE

DETAIL PAGE 13

06. 3. WILDLIFE FACILITIES	D	OUTPUT	MANHOURS	LABOR	EQUIPMNT	MATERIAL	TOTAL	CST	UNIT	COST
----------------------------	---	--------	----------	-------	----------	----------	-------	-----	------	------

06. WILDLIFE FACILITIES

06. 3. 1. B. .. WILDLIFE FACILITIES

CONTINGENCY OF 25%-NO PLANS, SPECS,SITE CONDITIONS NOT KNOWN

[02710 1000 Dbl Leaf Wood Gate Including Hardware ,]

4 Ft X 12 Ft Field Gate			8.68	93.54	28.42	175.00	296.96			
1.00 EA XCARB		0.25	9	94	28	175	297			296.96

[02712 4300 Barbed Wire Fence (Based On Post At 10 Ft Ctrs.,)]

Standard 5 Strand Fence			0.08	0.81	0.34	1.35	2.50			
3810.00 LF ULABL		37.50	305	3,098	1,282	5,144	9,524			2.50

[02721 9000 Median Barrier, Concrete]

Misc. Improvements			8.68	93.54	28.42	5000.00	5121.96			
1.00 EA XCARB		0.25	9	94	28	5,000	5,122			5121.96

WILDLIFE FACILITIES			322	3,285	1,339	10,319	14,943			
---------------------	--	--	-----	-------	-------	--------	--------	--	--	--



Tue 17 Mar 1992

U.S. Army Corps of Engineers  
PROJECT PLUMCR: - PLUM CREEK DETENTION DAM  
GDM ESTIMATE-PLUM CREEK  
08. ROADS, RAILROADS, AND BRIDGES

TIME 08:31:20

LED ESTIMATE

DETAIL PAGE 14

08. 2. ROADS	D	OUTPUT	MANHOURS	LABOR	EQUIPMNT	MATERIAL	TOTAL	CST	UNIT	COST
--------------	---	--------	----------	-------	----------	----------	-------	-----	------	------

08. ROADS, RAILROADS, AND BRIDGES

08. 2. .... 2. ROADWAY TO SUBGRADE  
CONTINGENCY OF 5%-NO PLANS OR SPECS

[02225 4230 Dozer W/Blade, 120Hp, (D-5H)]

EXCAVATION			0.06	0.64	0.99	0.00	1.63			
390.00 CY	XXQNB	30.00	23	250	386	0	636			1.63

[02226 2300 Sp Scraper Cap. 16 Bcy (12 Bm3) Scraper]

RANDOM FILL			0.01	0.20	0.76	0.00	0.96			
475.00 CY	COOSB	112.50	7	96	362	0	458			0.96

[02610 1000 Lime Stabilized Subgrade Based On Existing Soil]

6 In Layer Lime Stabilization			0.04	0.49	0.52	1.00	2.00			
2340.00 SY	COFCJ	150.00	94	1,138	1,212	2,340	4,690			2.00

ROADWAY TO SUBGRADE			123	1,484	1,960	2,340	5,784			
---------------------	--	--	-----	-------	-------	-------	-------	--	--	--

08. 2. .... 3. ROAD SURFACING  
CONTINGENCY OF 10%-MATERIAL SOURCE NOT KNOWN.

[02612 1200 Special Bituminous Or Macadam Stone Bases See]

T.B.S.C.			0.07	0.92	0.74	23.00	24.65			
195.00 CY	COKBF	81.75	14	179	144	4,485	4,807			24.65

ROAD SURFACING			14	179	144	4,485	4,807			
----------------	--	--	----	-----	-----	-------	-------	--	--	--

08. 2. .... R. ASSOCIATED GENERAL ITEMS  
CONTINGENCY OF 15%-NO DESIGN-SITE CONDITIONS UNKNOWN.

[02560 3200 Corrugated Metal Culverts]

22 In X 13 In - 16 Ga.			0.27	2.96	0.55	5.40	8.90			
28.00 LF	CODEK	21.88	8	83	15	151	249			8.90

[02711 4130 5 Ft (1.5M) Fence Height]

METAL FIELD GATE			0.80	8.13	3.37	75.50	87.00			
1.00 EA	ULABL	3.75	1	8	3	76	87			87.00

[02712 4300 Barbed Wire Fence (Based On Post At 10 Ft Ctrs.,)]

BARBED WIRE FENCE			0.08	0.81	0.34	0.90	2.05			
100.00 LF	ULABL	37.50	8	81	34	90	205			2.05

[02810 1000 Mechanical Seeding]

LABOR ID: RG0691 EQUIP ID: RG0691

CURRENCY IN DOLLARS

CREW ID: RG0691 UPB ID: RG0691

Tue 17 Mar 1992

U.S. Army Corps of Engineers  
 PROJECT PLUMCR: - PLUM CREEK DETENTION DAM  
 GDM ESTIMATE-PLUM CREEK  
 08. ROADS, RAILROADS, AND BRIDGES

TIME 08:31:20

ED ESTIMATE

DETAIL PAGE 15

08. 2. ROADS	D	OUTPUT	MANHOURS	LABOR	EQUIPMNT	MATERIAL	TOTAL	CST	UNIT	COST
TURFING			32.89	391.92	43.03	1770.00	2204.95			
0.30 ACR ULABE		0.04	10	118	13	531	661			2204.95
[02820 2000 Spreading Top Soil From Stock Pile]										
TOPSOIL			0.10	1.31	1.00	0.00	2.31			
125.00 CY CODLA		30.00	13	164	125	0	289			2.31
ASSOCIATED GENERAL ITEMS			39	454	190	848	1,491			

Tue 17 Mar 1992

U.S. Army Corps of Engineers  
PROJECT PLUMCR: - PLUM CREEK DETENTION DAM  
GDM ESTIMATE-PLUM CREEK  
30. PLANNING, ENGINEERING, DESIGN

TIME 08:31:20

LED ESTIMATE

DETAIL PAGE 16

30. ..	D	OUTPUT	MANHOURS	LABOR	EQUIPMNT	MATERIAL	TOTAL	CST	UNIT	COST
30. PLANNING, ENGINEERING, DESIGN										
30. .. ,..... --										
CONTINGENCY OF 25%-PRELIMINARY DEVELOPMENT STAGE OF DESIGN.										
E AND D			0.00	0.00	0.00	127000.00	127000.00			
1.00 LS		0.00	0	0	0	127,000	127,000	127000.00		
[01954 4220 Instrument Shelters]										
HTW SURVEY DURING PED			0.00	0.00	0.00	5000.00	5000.00			
1.00 LS		0.00	0	0	0	5,000	5,000	5000.00		
			-----	-----	-----	-----	-----			
			0	0	0	132,000	132,000			

Tue 17 Mar 1992

U.S. Army Corps of Engineers  
PROJECT PLUMCR: - PLUM CREEK DETENTION DAM  
GDM ESTIMATE-PLUM CREEK  
31. CONSTRUCTION MANAGEMENT

TIME 08:31:20

ED ESTIMATE

DETAIL PAGE 17

31. ..	D	OUTPUT	MANHOURS	LABOR	EQUIPMNT	MATERIAL	TOTAL	CST	UNIT	COST
--------	---	--------	----------	-------	----------	----------	-------	-----	------	------

31. CONSTRUCTION MANAGEMENT

31. . . . .

CONTINGENCY OF 25%-PRELIMINARY STAGE OF DESIGN.

SIQH			0.00	0.00	0.00	157000.00	157000.00			
	1.00 LS	0.00	0	0	0	157,000	157,000	157000.00		
			0	0	0	157,000	157,000			
PLUM CREEK FEASIBILITY STUDY-GDM			32,288	400,395	581,706	936,194	1,918,295			

Tue 17 Mar 1992

U.S. Army Corps of Engineers  
 PROJECT PLUMCR: - PLUM CREEK DETENTION DAM  
 GDM ESTIMATE-PLUM CREEK  
 \*\* CREW BACKUP \*\*

TIME 08:31:20

BACKUP PAGE 1

SRC	ITEM ID	DESCRIPTION	NO.	UOM	RATE	**** LABOR **** HOURS	COST	**** EQUIP **** HOURS	COST	TOTAL COST
	ALABE	4 B-laborer + 2 Electric Concrete Vibrators				PROD = 100%				CREW HOURS = 24
MIL	B-CEMFINRL	Cement Finishers	1.00	HR	16.63	1.00	16.63			16.63
MIL	B-LABORER L	Laborer (Semi-Skilled)	4.00	HR	10.00	4.00	39.99			39.99
MIL	B-LABORER F	Laborer (Semi-Skilled)	1.00	HR	10.50	1.00	10.50			10.50
MIL	C65WC002	E CONC VIB.,HI-FREQ,INT,2-1/2"HD	2.00	HR	1.44			2.00	2.88	2.88
MIL	XMIXX020	E Small Tools	0.68	HR	1.36			0.68	0.93	0.93
MIL	G10H0004	E GEN SET, 5.5 KW, PORTABLE	1.00	HR	1.49			1.00	1.49	1.49
TOTAL				HR		6.00	67.11	3.68	5.30	72.41
	ALABG	6 B-laborer + 2 Electric Concrete Vibrators				PROD = 100%				CREW HOURS = 55
MIL	B-CEMFINRL	Cement Finishers	1.00	HR	16.63	1.00	16.63			16.63
MIL	B-LABORER L	Laborer (Semi-Skilled)	5.00	HR	10.00	5.00	49.99			49.99
MIL	B-LABORER F	Laborer (Semi-Skilled)	1.00	HR	10.50	1.00	10.50			10.50
MIL	B-EQOPRCRNL	Eq Oper, Crane/Shovl	1.00	HR	21.34	1.00	21.34			21.34
MIL	C65MS005	E CONCRETE VIBRATOR, 6.0"	2.00	HR	1.98			2.00	3.96	3.96
MIL	C80LI007	E CRANE,HYD,TRKMTD, 60T W/110'BOO	1.00	HR	53.79			1.00	53.79	53.79
MIL	XMIXX020	E Small Tools	0.68	HR	1.36			0.68	0.93	0.93
MIL	B-EQOPROILL	Eq Oper, Oilers	1.00	HR	14.16	1.00	14.16			14.16
MIL	A15XX009	E AIR COMPR, 250 CFM, 100 PSI	1.00	HR	8.52			1.00	8.52	8.52
MIL	A20XX002	E AIR HOSE, 1", 50', HARDROCK	1.00	HR	0.38			1.00	0.38	0.38
TOTAL				HR		9.00	112.61	5.68	67.58	180.19
	ALABM	3 B-laborer + Misc Power Tools				PROD = 100%				CREW HOURS = 13
MIL	B-CARPNTERL	Carpenters	1.00	HR	15.82	1.00	15.82			15.82
MIL	B-CARPNTERF	Carpenters	1.00	HR	16.32	1.00	16.32			16.32
MIL	B-CEMFINRL	Cement Finishers	0.50	HR	16.63	0.50	8.31			8.31
MIL	B-RODMAN L	Rodmen (reinforcing)	0.50	HR	16.51	0.50	8.26			8.26
MIL	B-LABORER L	Laborer (Semi-Skilled)	3.00	HR	10.00	3.00	29.99			29.99
MIL	XMIXX010	E Misc. Power Tools	0.30	HR	5.74			0.30	1.72	1.72
MIL	XMIXX020	E Small Tools	1.16	HR	1.36			1.16	1.58	1.58
TOTAL				HR		6.00	78.71	1.46	3.30	82.01
	CLACC	3 B-laborer + 1 Hand Vibrating Compactor, 4 Hp				PROD = 100%				CREW HOURS = 185
MIL	B-LABORER F	Laborer (Semi-Skilled)	1.00	HR	10.50	1.00	10.50			10.50
MIL	B-LABORER L	Laborer (Semi-Skilled)	2.00	HR	10.00	2.00	19.99			19.99
MIL	C10WC003	E RAMMER,VIB,MAN, 13" X 11" SHOE	1.00	HR	2.03			1.00	2.03	2.03
MIL	XMIXX020	E Small Tools	0.23	HR	1.36			0.23	0.31	0.31
TOTAL				HR		3.00	30.49	1.23	2.34	32.83
	CODEK	5 B-laborer + 1 Backhoe Loader, 55 Hp				PROD = 100%				CREW HOURS = 2
MIL	B-LABORER L	Laborer (Semi-Skilled)	4.00	HR	10.00	4.00	39.99			39.99
MIL	B-LABORER F	Laborer (Semi-Skilled)	1.00	HR	10.50	1.00	10.50			10.50
MIL	B-EQOPRMEDL	Eq Oper, Medium	1.00	HR	14.16	1.00	14.16			14.16
MIL	L50CS002	E LDR,W/BH,WH,1.0CY FE BKT/24"DIP	1.00	HR	11.29			1.00	11.29	11.29
MIL	XMIXX020	E Small Tools	0.48	HR	1.36			0.48	0.65	0.65
TOTAL				HR		6.00	64.65	1.48	11.94	76.59

LABOR ID: RG0691

EQUIP ID: RG0691

CURRENCY IN DOLLARS

CREW ID: RG0691

UPB ID: RG0691

Tue 17 Mar 1992

U.S. Army Corps of Engineers  
 PROJECT PLUMCR: - PLUM CREEK DETENTION DAM  
 GDM ESTIMATE-PLUM CREEK  
 \*\* CREW BACKUP \*\*

TIME 08:31:20

BACKUP PAGE 2

SRC	ITEM ID	DESCRIPTION	NO.	UOM	RATE	**** LABOR **** HOURS	COST	**** EQUIP **** HOURS	COST	TOTAL COST
CODED		1 B-eqoprern + 1 Hydr. Excavator, 1-1/4 Cy, Cwlr			PROD = 100%			CREW HOURS =	13	
MIL	B-EQOPRCRNL	Eq Oper, Crane/Shovl	1.00	HR	21.34	1.00	21.34			21.34
MIL	B-LABORER L	Laborer (Semi-Skilled)	1.00	HR	10.00	1.00	10.00			10.00
MIL	H25CA006	E HYD EXCAV,CRWLR,1.25 CY BKT	1.00	HR	40.79			1.00	40.79	40.79
MIL	XMIXX020	E Small Tools	0.11	HR	1.36			0.11	0.15	0.15
TOTAL				HR		2.00	31.34	1.11	40.94	72.28
CODEX		4 B-laborer + 1 Hydr. Excavator, 1-1/2 Cy, Cwlr			PROD = 100%			CREW HOURS =	83	
MIL	B-LABORER F	Laborer (Semi-Skilled)	1.00	HR	10.50	1.00	10.50			10.50
MIL	B-LABORER L	Laborer (Semi-Skilled)	3.00	HR	10.00	3.00	29.99			29.99
MIL	B-EQOPRCRNL	Eq Oper, Crane/Shovl	1.00	HR	21.34	1.00	21.34			21.34
MIL	H25HI007	E HYD EXCAV,CRWLR,1.5 CY BKT	1.00	HR	42.09			1.00	42.09	42.09
MIL	XMIXX020	E Small Tools	0.11	HR	1.36			0.11	0.15	0.15
TOTAL				HR		5.00	61.83	1.11	42.24	104.07
CODLA		1 B-eqoprmed + 1 Front End Ldr, 1-1/2 Cy, Wheel			PROD = 100%			CREW HOURS =	451	
MIL	B-LABORER L	Laborer (Semi-Skilled)	1.00	HR	10.00	1.00	10.00			10.00
MIL	B-EQOPRMEDF	Eq Oper, Medium	2.00	HR	14.66	2.00	29.32			29.32
MIL	L40CS002	E LDR,FE,WH, 1.50 CY, 4-WD ARTIC	2.00	HR	14.99			2.00	29.98	29.98
TOTAL				HR		3.00	39.32	2.00	29.98	69.30
COOLB		1 B-eqoprmed + 1 Front End Ldr, 1-1/2 Cy, Cwlr			PROD = 100%			CREW HOURS =	4294	
MIL	B-LABORER L	Laborer (Semi-Skilled)	0.50	HR	10.00	0.50	5.00			5.00
MIL	B-EQOPRMEDF	Eq Oper, Medium	1.00	HR	14.66	1.00	14.66			14.66
MIL	L35CS002	E LDR,FE,CRWLR, MODEL 8550, 1.5 C	1.00	HR	21.77			1.00	21.77	21.77
TOTAL				HR		1.50	19.66	1.00	21.77	41.43
CODSB		1 B-eqoprmed + 1 Scraper, 15 Cy, 330 Hp			PROD = 100%			CREW HOURS =	1122	
MIL	B-LABORER L	Laborer (Semi-Skilled)	0.25	HR	10.00	0.25	2.50			2.50
MIL	B-EQOPRMEDF	Eq Oper, Medium	0.25	HR	14.66	0.25	3.67			3.67
MIL	B-EQOPRMEDL	Eq Oper, Medium	1.17	HR	14.16	1.17	16.57			16.57
MIL	S15CA001	E SCRAPER,SELF,14-20CY,24T,PWRSHF	1.00	HR	72.58			1.00	72.58	72.58
MIL	T10CA017	E BLADE, UNIVERSAL,HYDR,FOR D8	0.17	HR	6.84			0.17	1.16	1.16
MIL	T15CA015	E DOZER,CWLR,CAT D-8L, (ADD BLADE	0.17	HR	70.84			0.17	12.04	12.04
TOTAL				HR		1.67	22.73	1.34	85.79	108.52
CODTC		1 B-eqoprmed + 1 Dozer, Cat D-4h, 90 Hp			PROD = 100%			CREW HOURS =	491	
MIL	B-EQOPRMEDF	Eq Oper, Medium	0.25	HR	14.66	0.25	3.67			3.67
MIL	B-EQOPRMEDL	Eq Oper, Medium	1.00	HR	14.16	1.00	14.16			14.16
MIL	T10CA004	E BLADE, ANGLE, HYDR, FOR D4	1.00	HR	2.21			1.00	2.21	2.21
MIL	T15CA004	E DOZER,CWLR,D-4H,PS,(ADD BLADE)	1.00	HR	17.37			1.00	17.37	17.37
TOTAL				HR		1.25	17.83	2.00	19.58	37.41

LABOR ID: RG0691 EQUIP ID: RG0691

CURRENCY IN DOLLARS

CREW ID: RG0691 UPB ID: RG0691

Tue 17 Mar 1992

U.S. Army Corps of Engineers  
 PROJECT PLUMCR: - PLUM CREEK DETENTION DAM  
 GDM ESTIMATE-PLUM CREEK  
 \*\* CREW BACKUP \*\*

TIME 08:31:20

BACKUP PAGE 3

SRC	ITEM ID	DESCRIPTION	NO. UOM	RATE	**** LABOR HOURS	**** LABOR COST	**** EQUIP HOURS	**** EQUIP COST	TOTAL COST
CODTK		1 B-eqoprmed + 1 Dozer, Cat D-8L, 335 Hp			PROD = 100%			CREW HOURS = 885	
MIL	B-EQOPRCRNF	Eq Oper, Crane/Shovl	0.25 HR	21.84	0.25	5.46			5.46
MIL	B-EQOPRCRNL	Eq Oper, Crane/Shovl	1.00 HR	21.34	1.00	21.34			21.34
MIL	R40HY004	E ROLL,VIB,TOWED,STL,PAD,58"D,60"	1.00 HR	10.22			1.00	10.22	10.22
MIL	T10CA017	E BLADE, UNIVERSAL,HYDR,FDR D8	1.00 HR	6.84			1.00	6.84	6.84
MIL	T15CA015	E DOZER,CWLR,CAT D-8L, (ADD BLADE	1.00 HR	70.84			1.00	70.84	70.84
TOTAL			HR		1.25	26.80	3.00	87.90	114.70
COETF		2 B-laborer + 1 Dump Truck, 8 Cy			PROD = 100%			CREW HOURS = 3	
MIL	B-LABORER L	Laborer (Semi-Skilled)	2.00 HR	10.00	2.00	19.99			19.99
MIL	B-EQOPRMEF	Eq Oper, Medium	1.00 HR	14.66	1.00	14.66			14.66
MIL	B-TRKDVRHVL	Truck Drivers, Heavy	1.00 HR	10.12	1.00	10.12			10.12
MIL	L50CS002	E LDR,W/BH,WH,1.0CY FE BKT/24"DIP	1.00 HR	11.29			1.00	11.29	11.29
MIL	XMIXX020	E Small Tools	0.37 HR	1.36			0.37	0.50	0.50
MIL	T40XX008	E TRUCK OPT,REAR DUMP BODY, 8 CY	1.00 HR	2.44			1.00	2.44	2.44
MIL	T50GM016	E TRK, HWY, 3 AXLE, 41000 GVW, 6X	1.00 HR	19.19			1.00	19.19	19.19
TOTAL			HR		4.00	44.77	3.37	33.42	78.20
COFCJ		3 B-eqoprmed + 1-22 Ton Vibratory Steel Roller			PROD = 100%			CREW HOURS = 368	
MIL	-LABORER L	Laborer (Semi-Skilled)	2.00 HR	10.00	2.00	19.99			19.99
MIL	-LABORER F	Laborer (Semi-Skilled)	1.00 HR	10.50	1.00	10.50			10.50
MIL	B-EQOPRMEDL	Eq Oper, Medium	3.00 HR	14.16	3.00	42.48			42.48
MIL	G15CA003	E GRADER,MOTOR,CAT12-G, ARTIC	1.00 HR	26.54			1.00	26.54	26.54
MIL	XMIXX020	E Small Tools	0.29 HR	1.36			0.29	0.40	0.40
MIL	R30IG008	E ROLLER,SM-DR,SELF,12T,3WHL,3"OV	1.00 HR	13.36			1.00	13.36	13.36
MIL	R50DY005	E ROLLR,VIB,SD,SELF,84WX61D,22TON	1.00 HR	37.40			1.00	37.40	37.40
TOTAL			HR		6.00	72.97	3.29	77.70	150.67
COFWI		1 B-eqoprmed + 1 Truck 3ax, W/3000 Gal Water Tnk			PROD = 100%			CREW HOURS = 3948	
MIL	B-EQOPRMEF	Eq Oper, Medium	0.25 HR	14.66	0.25	3.67			3.67
MIL	B-TRKDVRHVL	Truck Drivers, Heavy	1.00 HR	10.12	1.00	10.12			10.12
MIL	B-EQOPRLT L	Eq Oper, Light	0.50 HR	10.42	0.50	5.21			5.21
MIL	P55GR004	E PUMP,WATER,SUB,6",1950GPM/40'HD	0.50 HR	8.31			0.50	4.16	4.16
MIL	T40XX033	E WATER TANK, 3000 GAL (ADD TRUCK	1.00 HR	3.03			1.00	3.03	3.03
MIL	T50GM016	E TRK, HWY, 3 AXLE, 41000 GVW, 6X	1.00 HR	19.19			1.00	19.19	19.19
TOTAL			HR		1.75	18.99	2.50	26.38	45.37
COKBF		3 B-eqoprmed + 1 Spreader, Aggregate-gas			PROD = 100%			CREW HOURS = 8	
MIL	A10ET001	E CHIPSFRD,SELF-PROP,MECH.,10'W	1.00 HR	16.38			1.00	16.38	16.38
MIL	A25RS007	E ASPHALT DISTR,3000 GAL,ADD TRUC	0.50 HR	13.45			0.50	6.73	6.73
MIL	B-LABORER L	Laborer (Semi-Skilled)	2.00 HR	10.00	2.00	19.99			19.99
MIL	B-EQOPRMEF	Eq Oper, Medium	0.50 HR	14.66	0.50	7.33			7.33
MIL	B-EQOPRMEDL	Eq Oper, Medium	3.00 HR	14.16	3.00	42.48			42.48
MIL	B-TRKDVRHVL	Truck Drivers, Heavy	0.50 HR	10.12	0.50	5.06			5.06
MIL	XMIXX020	E Small Tools	0.25 HR	1.36			0.25	0.34	0.34
MIL	R30IG003	E ROLLER,STATIC,SELF,15T, 11 TIRE	1.00 HR	12.90			1.00	12.90	12.90
MIL	R30IG008	E ROLLER,SM-DR,SELF,12T,3WHL,3"OV	1.00 HR	13.36			1.00	13.36	13.36

Tue 17 Mar 1992

U.S. Army Corps of Engineers  
PROJECT PLUMCR: - PLUM CREEK DETENTION DAM  
GDM ESTIMATE-PLUM CREEK  
\*\* CREW BACKUP \*\*

TIME 08:31:20

BACKUP PAGE 4

SRC	ITEM ID	DESCRIPTION	NO. UOM	RATE	**** LABOR HOURS	**** COST	**** EQUIP HOURS	**** COST	TOTAL COST
MIL	T50IT004	E TRK, HWY, 43,000GVW, 6X4, 3 AXL	0.50 HR	21.26			0.50	10.63	10.63
TOTAL			HR		6.00	74.86	4.25	60.34	135.20
EELEB 2 B-electrn + Small Tools					PROD = 100%				CREW HOURS = 4
MIL	B-ELECTRN	F Electricians	0.50 HR	23.91	0.50	11.96			11.96
MIL	B-ELECTRN	L Electricians	2.00 HR	23.41	2.00	46.82			46.82
MIL	XMIXX020	E Small Tools	0.23 HR	1.36			0.23	0.31	0.31
TOTAL			HR		2.50	58.78	0.23	0.31	59.09
EELEJ 5 B-electrn + 1 Line Truck					PROD = 100%				CREW HOURS = 66
MIL	B-ELECTRN	L Electricians	2.00 HR	23.41	2.00	46.82			46.82
MIL	B-ELECTRN	F Electricians	1.00 HR	23.91	1.00	23.91			23.91
MIL	B-ELECTRN	A Electricians	2.00 HR	18.73	2.00	37.46			37.46
MIL	XMIXX020	E Small Tools	0.49 HR	1.36			0.49	0.67	0.67
MIL	P40RE001	E TRK,HWY,LINE TRK W/AERIAL PLATF	1.00 HR	28.60			1.00	28.60	28.60
TOTAL			HR		5.00	108.19	1.49	29.27	137.45
SIWRC 3 B-rodman + Small Tools					PROD = 100%				CREW HOURS = 26
MIL	B-RODMAN	F Rodmen (reinforcing)	1.00 HR	17.01	1.00	17.01			17.01
MIL	B-RODMAN	L Rodmen (reinforcing)	3.00 HR	16.51	3.00	49.54			49.54
MIL	XMIXX020	E Small Tools	0.68 HR	1.36			0.68	0.93	0.93
TOTAL			HR		4.00	66.55	0.68	0.93	67.48
ULABA 1 B-laborer + Small Tools					PROD = 200%				CREW HOURS = 115
MIL	B-LABORER	F Laborer (Semi-Skilled)	0.25 HR	10.50	0.25	2.62			2.62
MIL	B-LABORER	L Laborer (Semi-Skilled)	1.00 HR	10.00	1.00	10.00			10.00
MIL	XMIXX020	E Small Tools	0.13 HR	1.36			0.13	0.18	0.18
TOTAL			HR		1.25	12.62	0.13	0.18	12.80
ULABB 2 B-laborer + Small Tools					PROD = 100%				CREW HOURS = 1
MIL	B-LABORER	L Laborer (Semi-Skilled)	2.00 HR	10.00	2.00	19.99			19.99
MIL	B-LABORER	F Laborer (Semi-Skilled)	0.50 HR	10.50	0.50	5.25			5.25
MIL	XMIXX020	E Small Tools	0.27 HR	1.36			0.27	0.37	0.37
TOTAL			HR		2.50	25.24	0.27	0.37	25.61
ULABE 1 B-laborer + Misc. Power Tools					PROD = 100%				CREW HOURS = 708
MIL	B-LABORER	L Laborer (Semi-Skilled)	1.00 HR	10.00	1.00	10.00			10.00
MIL	B-LABORER	F Laborer (Semi-Skilled)	0.25 HR	10.50	0.25	2.62			2.62
MIL	XMIXX010	E Misc. Power Tools	0.22 HR	5.74			0.22	1.26	1.26
MIL	XMIXX020	E Small Tools	0.09 HR	1.36			0.09	0.12	0.12
TOTAL			HR		1.25	12.62	0.31	1.39	14.01

LABOR ID: RG0691 EQUIP ID: RG0691

CURRENCY IN DOLLARS

CREW ID: RG0691 UPB ID: RG0691



Tue 17 Mar 1992

U.S. Army Corps of Engineers  
 PROJECT PLUMCR: - PLUM CREEK DETENTION DAM  
 GDM ESTIMATE-PLUM CREEK  
 \*\* CREW BACKUP \*\*

TIME 08:31:20

BACKUP PAGE 5

SRC	ITEM ID	DESCRIPTION	NO. UOM	RATE	**** LABOR HOURS	**** COST	**** EQUIP HOURS	**** COST	TOTAL COST
ULABF 3 B-laborer + Small Tools					PROD = 100%		CREW HOURS = 9		
MIL	B-LABORER L	Laborer (Semi-Skilled)	2.00 HR	10.00	2.00	19.99			19.99
MIL	B-LABORER F	Laborer (Semi-Skilled)	1.00 HR	10.50	1.00	10.50			10.50
MIL	XMIXX020	E Small Tools	0.47 HR	1.36			0.47	0.64	0.64
TOTAL			HR		3.00	30.49	0.47	0.64	31.13
ULABL 3 B-laborer + 1-3 Ton Flatbed Truck					PROD = 100%		CREW HOURS = 105		
MIL	B-LABORER L	Laborer (Semi-Skilled)	2.00 HR	10.00	2.00	19.99			19.99
MIL	B-LABORER F	Laborer (Semi-Skilled)	1.00 HR	10.50	1.00	10.50			10.50
MIL	XMIXX020	E Small Tools	0.47 HR	1.36			0.47	0.64	0.64
MIL	T40XX012	E TRUCK OPT,FLATBED, 8' x 9.0'	1.00 HR	0.46			1.00	0.46	0.46
MIL	T50GM012	E TRK, HWY, 2 AXLE, 24000 GVW, 4X	1.00 HR	11.52			1.00	11.52	11.52
TOTAL			HR		3.00	30.49	2.47	12.62	43.11
UOEHC 5 B-laborer + 1- 22 Ton Crane, Hydraulic					PROD = 100%		CREW HOURS = 16		
MIL	B-LABORER F	Laborer (Semi-Skilled)	1.00 HR	10.50	1.00	10.50			10.50
MIL	B-LABORER L	Laborer (Semi-Skilled)	4.00 HR	10.00	4.00	39.99			39.99
MIL	B-EQOPRMEDL	Eq Oper, Medium	1.00 HR	14.16	1.00	14.16			14.16
MIL	C75PH004	E CRANE,HYD,SELF, 22 TON	1.00 HR	33.41			1.00	33.41	33.41
MIL	MIXX020	E Small Tools	0.60 HR	1.36			0.60	0.82	0.82
TOTAL			HR		6.00	64.65	1.60	34.23	98.87
XCARB 1 X-carpnter + Misc. Power Tools					PROD = 100%		CREW HOURS = 8		
MIL	XMIXX010	E Misc. Power Tools	1.00 HR	5.74			1.00	5.74	5.74
MIL	XMIXX020	E Small Tools	1.00 HR	1.36			1.00	1.36	1.36
MIL	X-CARPNTERF	Outside Carpenter	0.17 HR	13.21	0.17	2.25			2.25
MIL	X-CARPNTERL	Outside Carpenter	1.00 HR	12.71	1.00	12.71			12.71
MIL	X-LABORER L	Outside Laborer	1.00 HR	8.43	1.00	8.43			8.43
TOTAL			HR		2.17	23.39	2.00	7.10	30.49
XXQNB 1 X-eqoprmed + 1 Dozer, Cat D-5h, 120 Hp					PROD = 100%		CREW HOURS = 4440		
MIL	T10CA006	E BLADE, STRAIGHT,HYDR,FOR D5	1.00 HR	2.57			1.00	2.57	2.57
MIL	T15CA006	E DOZER,CWLR,D-5H,PS,(ADD BLADE)	1.00 HR	27.14			1.00	27.14	27.14
MIL	X-LABORER L	Outside Laborer	0.50 HR	8.43	0.50	4.21			4.21
MIL	X-EQOPRMEDL	Outside Equip. Op. Medium	1.00 HR	11.89	1.00	11.89			11.89
MIL	X-EQOPRMEDF	Outside Equip. Op. Medium	0.25 HR	12.39	0.25	3.10			3.10
TOTAL			HR		1.75	19.21	2.00	29.71	48.92
XXQND 1 X-eqpphvy + 1 Dozer, Cat D-7h, 215 Hp					PROD = 100%		CREW HOURS = 171		
MIL	T10CA013	E BLADE, UNIVERSAL,HYDR,FOR D7	1.00 HR	5.32			1.00	5.32	5.32
MIL	T15CA013	E DOZER,CWLR,D-7H,PS,(ADD BLADE)	1.00 HR	53.77			1.00	53.77	53.77
MIL	X-LABORER L	Outside Laborer	0.50 HR	8.43	0.50	4.21			4.21
MIL	X-EQOPRMEDL	Outside Equip. Op. Medium	1.00 HR	11.89	1.00	11.89			11.89
MIL	X-EQOPRMEDF	Outside Equip. Op. Medium	0.25 HR	12.39	0.25	3.10			3.10
TOTAL			HR		1.75	19.21	2.00	59.09	78.30

Tue 17 Mar 1992

U.S. Army Corps of Engineers  
PROJECT PLUMCR: - PLUM CREEK DETENTION DAM  
GDM ESTIMATE-PLUM CREEK

TIME 08:31:20

REPORT

ERROR PAGE 1

-----  
No errors detected ....

\*\*\* END OF ERROR REPORT \*\*\*

**APPENDIX 6 - U.S. FISH AND WILDLIFE SERVICE  
COORDINATION ACT REPORT**

**APPENDIX 6**

**U.S. FISH AND WILDLIFE SERVICE  
COORDINATION ACT REPORT**

**TABLE OF CONTENTS**

U.S. FISH AND WILDLIFE SERVICE COORDINATION ACT REPORT

TULSA DISTRICT RESPONSE TO U.S. FISH AND WILDLIFE SERVICE  
MITIGATION RECOMMENDATIONS

MITIGATION PLAN PLUM CREEK FLOOD CONTROL PROJECT



United States Department of the Interior  
FISH AND WILDLIFE SERVICE

Ecological Services  
222 S. Houston, Suite A  
Tulsa, Oklahoma 74127



February 18, 1992

District Engineer  
U.S. Army Corps of Engineers  
P. O. Box 61  
Tulsa, Oklahoma 74121-0061

Dear Sir:

This letter transmits the Fish and Wildlife Coordination Act Report on the Tulsa District - U.S. Army Corps of Engineers' Plum Creek Flood Protection Project, Wichita County, Texas. The Corps of Engineers' (Corps) comments on the draft report of September 1991 were considered in preparing the final report.

The mitigation plan detailed in this report is contingent upon the vegetation within the detention area not being cleared during construction. The flowage easement agreement must contain restrictions or specifications prohibiting vegetation clearing after construction. Otherwise, further consultation will be necessary to determine additional mitigation necessary to compensate for additional vegetation losses.

We appreciate the cooperation of your staff in our investigation of this project. Please contact us if you have any questions or need further assistance.

Sincerely yours,

*Ja Charles M. Scott*  
Stephen W. Forsythe  
Field Supervisor

Enclosures (5)

Distribution:

- (1) Director, Fish and Wildlife Service, Washington, D.C. (DHC/BFA)
- (3) Regional Director, Fish and Wildlife Service, Albuquerque, NM (AWE)
- (1) Field Supervisor, Ecological Services, Arlington, TX
- (2) Regional Administrator, Environmental Protection Agency, Dallas, TX
- (3) USDI Natural Resources Library, Washington, D.C.
- (2) Executive Director, Texas Parks and Wildlife Department, Austin, TX

LKO:dc

FISH AND WILDLIFE COORDINATION ACT REPORT  
ON  
PLUM CREEK FLOOD PROTECTION PROJECT  
WICHITA COUNTY, TEXAS (CE)

Prepared by:

L. Karolee Owens  
Ecological Services Field Office  
U.S. Fish and Wildlife Service

Tulsa, Oklahoma  
February 1992

## INTRODUCTION

This report provides the U.S. Fish and Wildlife Service's (Service) evaluation of the fish and wildlife resources affected by the Plum Creek Flood Protection Project, Wichita County, Wichita Falls, Texas. It is intended to accompany the U.S. Army Corps of Engineers (Corps) Definite Project Report on the feasibility of providing flood protection for existing residential, commercial, and public areas in the floodplain of the main branch of Plum Creek. Specifically, it provides our evaluation of fish and wildlife resources under existing conditions and projections of changes that would occur following implementation of this project. Approaches to reduction of environmental impacts and recommendations for mitigating impacts to fish and wildlife resources are included.

This report has been prepared under the authority of the Fish and Wildlife Coordination Act (48 Stat. 401, as amended; 16 U.S.C. 661 et seq.) and fulfills the reporting requirement set forth in Section 2(b) of the Act. The Texas Parks and Wildlife Department has reviewed and concurred with this report as indicated in the enclosed letter, dated November 1, 1991, from Robert W. Spain, Chief Environmental Assessment Branch, Resource Protection Division.

The Tulsa District Corps of Engineers originally evaluated the Plum Creek drainage in 1960. The 1960 plan included channel improvement and diversion of the water through an existing drainage ditch to the Wichita River. The Service report of March 24, 1960 found that the proposed plan of development would have no significant effect on fish and wildlife resources of the area, nor would it offer any appreciable opportunity for fish and wildlife improvement. Because there was no local sponsor willing to cost share construction, the Corps suspended planning on the 1960 project.

A flood insurance study of the City of Wichita Falls completed by the Tulsa District, Corps of Engineers in 1977 outlined the floodway, the 100-year flood plain, and the 500-year flood plain. This study is being updated using new hydrologic and hydraulic models due to increased urbanization and changed base conditions.

The current project was initiated by the Corps at the request of the City of Wichita Falls. Reconnaissance studies were conducted under authority of Section 205 of the 1948 Flood Control Act, as amended.

## DESCRIPTION OF THE WATERSHED

The four main drainages of Plum Creek watershed are characterized as seasonally intermittent low order streams. Figure 1 depicts these drainages and the boundary of Plum Creek watershed. The main branch of Plum Creek begins in east central Wichita County, Texas, about 2.5 miles west of Sheppard Air Force Base. This stream flows south for approximately 6 miles to its confluence with the Wichita River. Collectively, Plum Creek and its tributaries drain about 17 square miles.

Terrain of the watershed consists of gently rolling hills on uplands and narrow, nearly level flood plains along creeks and small drainageways. Elevations range from 930 to 1,085 feet above mean sea level. Soils in the study area consist of moderately deep, loamy soils with some gravelly and stony loams in upland areas, and deep loamy soils along the creek.

Dominant land uses along the main branch of Plum Creek are agricultural and urban development. In the upper segment of the creek, mesquite grasslands, steeper, gravelly uplands, and drainageways are used for grazing livestock. On more level areas of uplands some cultivation of wheat occurs. Urban development is largely confined to lower reaches of the creek, which has been channelized in this area. Presently, about 50 percent of the main branch is urbanized, and single family housing has developed adjacent to the streambank.

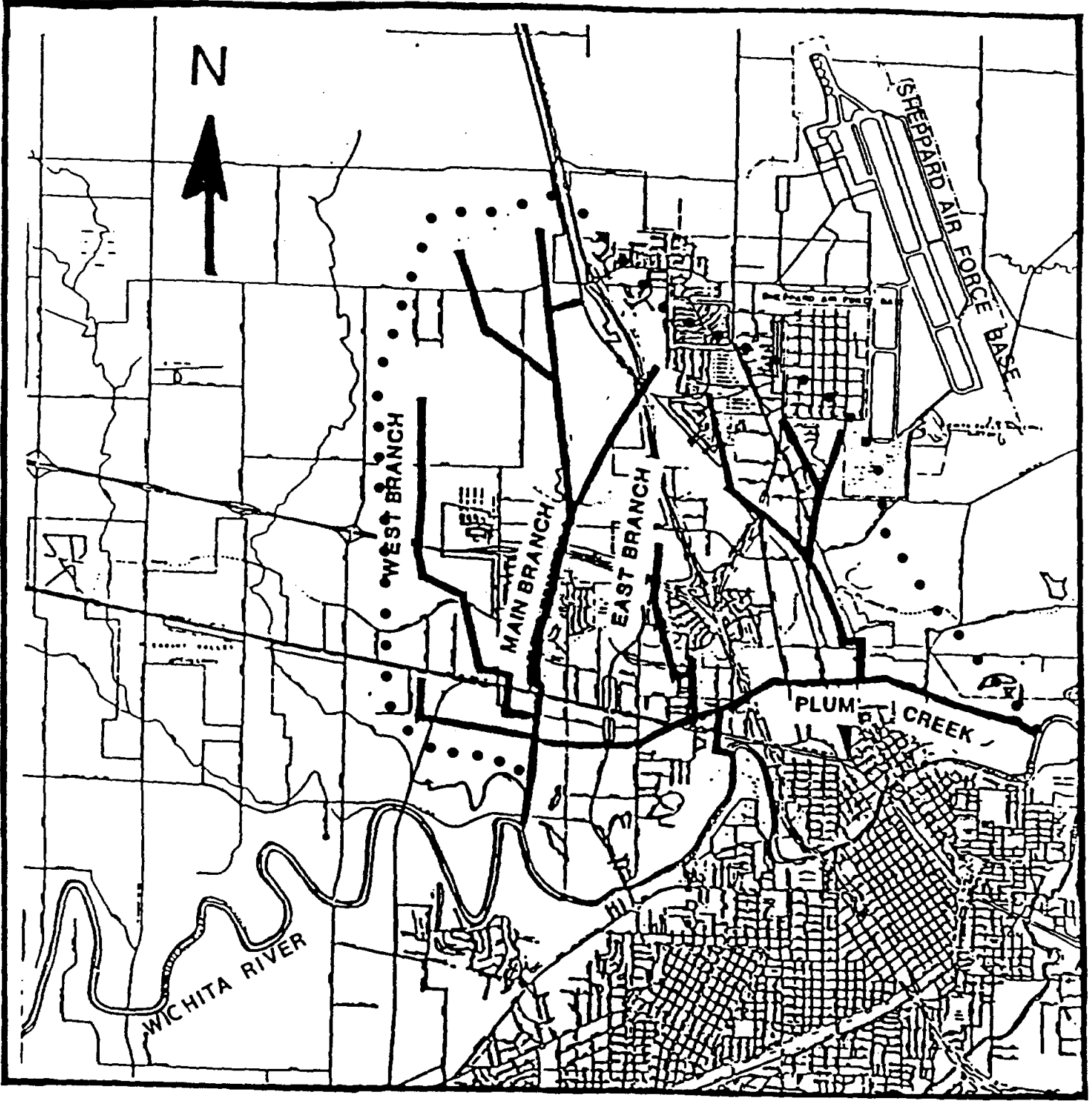

Figure 1. Plum Creek watershed boundary.



## DESCRIPTION OF THE PROJECT

The project being considered as a solution to flooding problems of Plum Creek is an upstream detention area, with a project life of 50 years. The impoundment would be located on the main branch of Plum Creek, 0.5 miles North of U.S. 287 (see Fig. 2).

The proposed detention structure would be an earthen embankment approximately 2900 feet long with the top of dam elevation at 1014 feet (including 3 feet of freeboard), NGVD. There would be a 165 foot wide emergency spillway at elevation 1002 feet to allow passage of the probable maximum flood. At the maximum flood pool elevation (1,011 feet above mean sea level), 330 acres would be inundated. An uncontrolled 30 inch diameter pipe outlet would be used to drain the impoundment and allow passage of low flows. The Corps estimates it would take 7 to 10 days to drain the detention pond.

A diversion ditch approximately 1600 feet long may be constructed north of the detention structure to divert water flow from an east tributary into Plum Creek.

Land requirements for the project include approximately 23 acres in fee for the damsite and spillway, an easement on 0.5 acres for an access road, and flowage easements on 330 acres that could be inundated during maximum flows. An additional fee acquisition of 7.5 acres (Fig. 2) from the toe of the spillway to the existing channel would be required for hydrologic safety because of increased velocity of the flow from the toe of the spillway due to modified conditions.

An additional requirement is a borrow easement on 75 acres to provide fill for the embankment and excavation of the inactive pool. Borrow areas within the detention site would not be within 100 feet of the creek bank. The structure of the borrow areas may be modified to serve as a sediment basin and to create water areas of varying depths to allow colonization by wetland plant species for use by wildlife. The borrow area may receive flows from the diversion ditch or be graded to drain from the tributary to Plum Creek (through the borrow area).

## FISH AND WILDLIFE RESOURCES WITHOUT THE PROJECT

The project is situated in the mesquite-buffalograss section of the prairie brushland Ecoregion (Bailey 1980). Within developed portions of the watershed, bird species diversity is limited primarily to species adapted to urban environments such as blue jays, mockingbirds, robins, cardinals, starlings, and house sparrows. Due to urban development in the lower part of the main branch of Plum Creek, the best remaining wildlife habitat is along riparian zones and mesquite grasslands of the upper segment of the creek.

Acreage of mesquite grasslands far exceed that of riparian zones in the project area. Mesquite grassland areas are characterized by scattered mesquite and wild plum thickets. The grass community is typified by side-oats grama, little blue-stem, blue grama, and buffalo grass. The most productive upland terrestrial habitats generally occur in prairie-to-riparian transition zones where wildlife species can use food and cover provided by both cover types. These mesquite grassland areas provide good quality habitat for such species as white-tailed eastern cottontail, and coyote. Nesting habitat for migratory and non-migratory birds such as mourning doves, flycatchers, meadowlarks, field sparrows, bobwhite and raptors is also provided for in mesquite grasslands.

Figure 2. Proposed Plum Creek Flood Control Project.

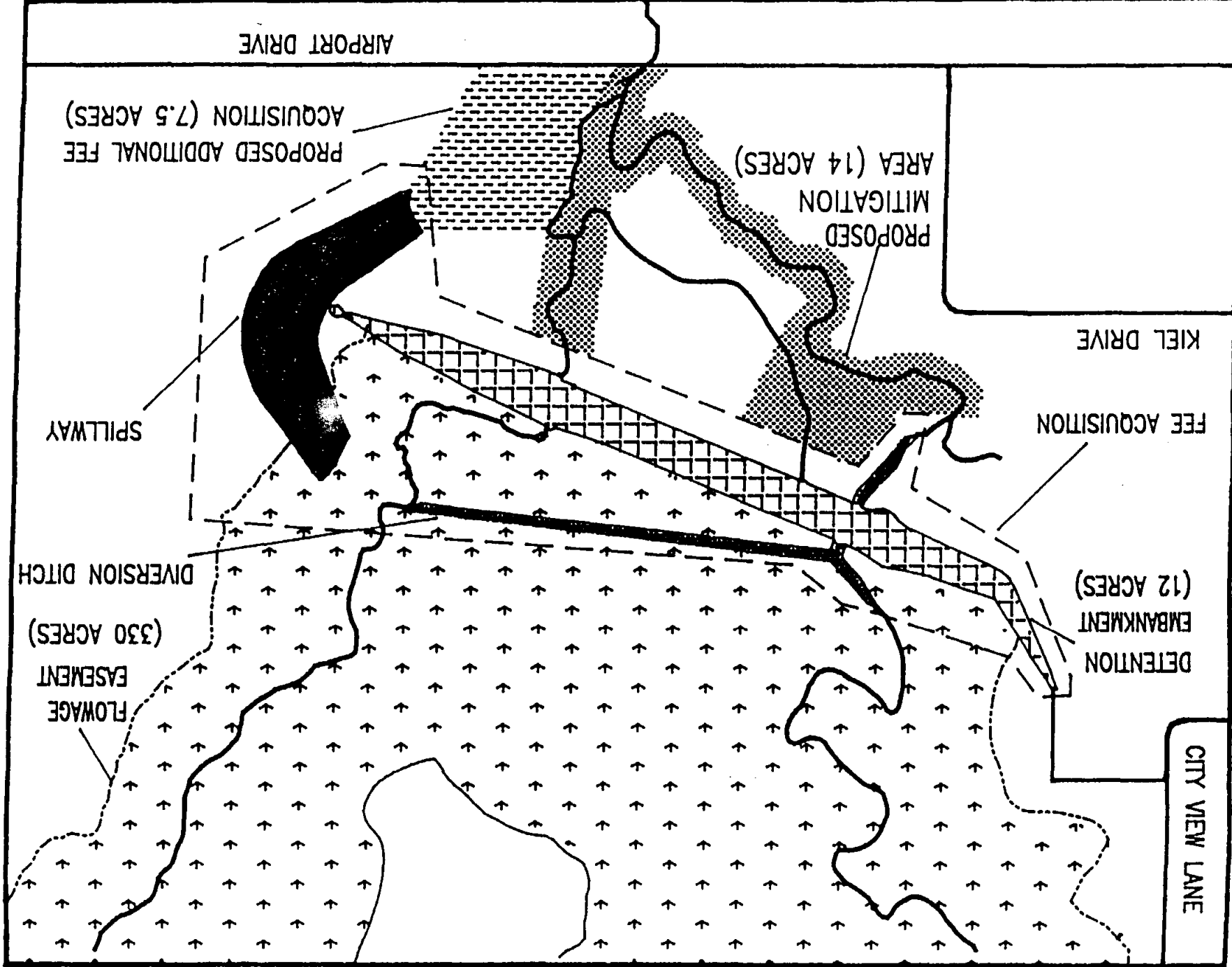

Riparian timber zones are characterized by an overstory of trees such as hackberry, American elm, black willow, and bumelia. The understory consists mainly of grasses, vines, and herbaceous plants. These narrow riparian zones are extremely valuable as protective cover for migrating and dispersing wildlife, and as nesting habitat for resident songbirds such as warblers, orioles, chickadees, wrens, and sparrows. Small mammals such as raccoons, fox squirrels, opossums, skunks, rats, and mice are also associated with riparian zones along the watershed. Using an abbreviated Habitat Evaluation Procedures, the Service determined the Habitat Suitability Index (HSI) for riparian timber in the project area (fox squirrel and raccoon were used as evaluation species) was 0.45 (on a scale of 0 to 1.0).

Riparian zones have ecological importance far beyond their relatively small acreage. They typically have a greater quantity and diversity of vegetation than adjoining land. These areas remove sediment from runoff water as it moves through the vegetation, thus helping to purify water and enrich the riparian zone. They also act as sponges by holding water in streambanks, thereby raising the water table in the surrounding area and providing a more stable stream flow. During floods, healthy riparian areas dissipate the energy of flood waters and reduce flood peaks. Riparian areas provide food, water, shade, and cover for fish and wildlife, and forage for both wild and domestic grazing animals, as well as recreational opportunities.

Aquatic resources are minimal in the upper reaches of Plum Creek due to intermittent presence of water and agricultural runoff. The fishery resources of this stream are expected to consist of adaptive fishes tolerant of these limited habitat conditions, such as mosquito fish, green sunfish, red shiner, and other common minnow species. Due to deleterious effects of bank disturbance, channel modification, and urban runoff, aquatic resources are virtually nonexistent in lower reaches of the creek.

The project area is presently in private ownership and does not offer opportunities for public oriented fish and wildlife recreation.

Federally listed threatened or endangered species which might occur in the project area are the least tern (*Sterna antillarum*), whooping crane (*Grus americana*), and piping plover (*Charadrius melodus*). The whooping crane and piping plover migrate through Wichita County, and the least tern is known to nest in suitable habitat along the Red River. However, it is unlikely these species would utilize Plum Creek watershed; therefore, no further Section 7 consultation is required.

The Texas kangaroo rat (*Dipodomys elator*) has been located in an area northwest of Wichita Falls in the general area of the proposed project site. The Texas kangaroo rat is a federal category 2 candidate species and a state threatened species. Its preferred habitat has been described as clay soils with sparse grass and small mesquite; however, the kangaroo rat does not require the presence of mesquite and may be found in areas lacking mesquite. During the summer of 1990, biologists from the Corps and Service performed a cursory evaluation of the detention site to determine if habitat for the Texas kangaroo rat was present. They assessed the site did not contain habitat for the rat, as described in current literature, and no burrows were found near the base of mesquite trees. The only way to accurately determine the presence or absence of this rare species in the project site is to conduct a trapping survey. Federal candidate species have no legal protection under the Endangered Species Act and is provided in this document for planning purposes only. Additional information on the kangaroo rat is included with the attached letter of concurrence from the Texas Parks and Wildlife Department.

## EVALUATION OF THE PROJECT

The most direct impacts on wildlife resources would occur from loss of habitat due to construction of the detention embankment, borrow sites, and access road. Approximately 4 acres of riparian timber and 8 acres of mesquite grasslands would be impacted by the detention embankment and access road. Seventy five acres of unknown habitat would be impacted by borrow sites. Impacts would also occur if riparian and other native vegetation is removed from all or part of the 330 acres of flowage easement to increase water storage capacity. Approximately 40 acres of riparian habitat could potentially be lost if the detention site is cleared. Some bank erosion and channel scouring could occur directly downstream of the control structure during flood water discharge.

The proposed embankment would cross two forks of the creek. Alteration of the water regime in the fork not receiving water from the drain pipe could result in the loss of the riparian vegetation in the area downstream from the embankment. The proposed diversion of flows from the tributary to Plum Creek (upstream of the embankment and within the detention site) through a ditch or drainage would result in further loss of riparian characteristics along the tributary.

Effects on aquatic resources of the creek should be minimal due to their sparsity and low habitat value.

Wildlife populations in Plum Creek watershed currently are limited by existing land use patterns and overall moderate carrying capacity of the habitat. Urbanization has resulted in continual loss and degradation of quality wildlife habitat. The continuous but narrow riparian corridor along upper reaches of Plum Creek should be protected and enhanced if possible. This area currently supports several species of mammals and birds. Riparian areas serve as transportation corridors for many animals, hinder bank caving, protect streams from sedimentation, and have aesthetic value.

The Service's Mitigation Policy (Federal Register 46 [15]: 7644-7663) provides guidance for formulation of measures to offset project impacts on habitat value. Habitat value and abundance as determined through use of selected evaluation species are key elements in setting appropriate planning goals for mitigating habitat losses. Species used to evaluate the riparian habitat of Plum Creek included migrating and nesting songbirds, and small mammals such as fox squirrels and raccoons. It was determined that the riparian habitat of Plum Creek is of medium value for the evaluation species and is relatively abundant on a national basis. The Service's mitigation goal for riparian habitat is no net loss of habitat value while minimizing loss of in-kind habitat value. Mesquite grasslands in the site possess medium to low habitat value for evaluation species and are abundant within the project area. The mitigation goal for mesquite grasslands is to minimize loss of habitat value.

At the Corps of Engineers request, the Service conducted an abbreviated assessment of riparian timber impacts using the Habitat Evaluation Procedures. This assessment was confined to riparian timber because this is the only habitat in the project area that the Service is seeking compensation for. The results of the HEP are presented in Table 1. The project would result in an annual net loss of 1.79 habitat units over the life of the project, requiring a 14.5-acre mitigation area to properly compensate for this loss.

Table 1. Results of HEP on riparian timber in the Plum Creek Flood Protection Project.

Target Year	Area	<u>Without project</u>			<u>With project</u>		
	(acres)	HSI	HUV <sup>1</sup>		(acres)	HSI	HUV <sup>1</sup>
0 <sup>2</sup>	4	0.45	1.8		4	0.45	1.8
1 <sup>3</sup>	4	0.45	1.8		0	0	0
25	4	0.45	1.8		0	0	0
50	4	0.45	1.8		0	0	0

Average Annual Habitat Units (AAHU) without project = 1.8

Average Annual Habitat Units (AAHU) with project = 0.01

Net change in AAHU over life of the project = -1.79

Area needed for compensation = 14.5 acres

<sup>1</sup>Habitat Unit Value (HUV) = Area x HSI

<sup>2</sup>Target Year 0 = baseline (existing) conditions

<sup>3</sup>Target Year 1 = end of project construction

#### DISCUSSION/MITIGATION/ENHANCEMENT

To minimize impacts, the detention site should not be cleared of vegetation, especially riparian timber. Additionally, precautions should be taken to prevent the site from being cleared after construction (e.g. restrictions in the flowage easement). If it is decided by the Corps that all or a portion of the flowage easement area must be cleared, additional mitigation for riparian habitat would be required. Borrow areas and access roads needed to construct and maintain the detention embankment should be located in mesquite grasslands, away from riparian areas. Bank protection may be needed directly downstream of the outlet discharge to prevent bank erosion and channel scouring.

The unavoidable loss of about 4 acres of riparian timber associated with construction of the embankment and access road can be mitigated by acquiring, in fee title, approximately 14 acres of existing riparian habitat and managing the area to improve wildlife habitat. It is preferred that this mitigation area be a continuous tract of land on both sides of Plum Creek downstream of the detention structure (see Figure 2). Estimated first costs to establish this mitigation area would be \$5,110 for acquisition (\$365/acre), \$3,000 for fencing, and \$2,500 for initial development (signs, plantings, etc.), for a total of \$10,610.

Future habitat losses within the mitigation area should be avoided by placing restrictions on project land deeds. For example, these restrictions could prohibit alteration of vegetation and hydrology of the property by cutting, cultivation, harvesting wood, dumping of refuse, discing, draining, channeling, filling, pumping, diking, impounding or otherwise diverting or affecting the natural flow of surface or groundwaters. Such restrictions would support Section 1 of Executive Order 11988 - Floodplain Management, which states in part: "Each agency shall . . . restore and preserve the natural and beneficial values served by floodplains . . . ."

The mitigation area should be managed by the City of Wichita Falls and set aside as a natural area or greenbelt. Benefits of a greenbelt to the citizens of

Wichita Falls include recreational opportunities, plant and animal conservation, enhanced awareness and appreciation of wildlife, and a more aesthetically pleasing landscape. Nonconsumptive uses of wildlife such as nature education, birdwatching, and nature trails also could provide benefits to the City.

Incorporation of "environmental features" into project design also would help meet environmental goals and objectives. Minor design/operational changes would benefit wetlands and unique habitats, recreation needs, and further the goals of the North American Waterfowl Management Plan. Other new Corps environmental mandates/policies may provide a means to bring such features into project design, as well as implement them. Such changes include establishing shallow water (wetland) areas. This could be accomplished by modifying the design of the proposed borrow area within the detention site. The borrow site would need to have gradually sloping sides (10:1 to 15:1) and be in a soil type that would hold water (such as the Deandale soils which dominate the detention site). The borrow site should include a central deep water area at least 10 feet deep and islands of unexcavated grassland should be left intact to provide island habitat and roost sites when the borrow site fills with water. Total area of the islands should equal 5-10% of the borrow area. The area of each island should be 200 square feet or greater and each island should be greater than 100 feet from the edges of the borrow site. The edges of the borrow site should be irregular in shape (Fig. 3). To provide a source of water, the proposed diversion ditch could be routed through the borrow area or the area graded to provide drainage from the tributary into and out of the borrow area. The modified borrow site could serve a dual purpose as a sedimentation basin. After flood waters recede, this depressional area would retain water and attract waterfowl and other wildlife.

#### RECOMMENDATIONS

In view of the foregoing, we recommend that:

1. Vegetation, (especially riparian timber) within the detention area not be cleared and that the flowage easement agreement contain restrictions or specifications prohibiting vegetation clearing after construction.
2. Borrow areas and access/work roads needed to construct and maintain the project be located away from riparian areas.
3. A 14-acre riparian habitat mitigation area be established along Plum Creek downstream of the detention pond. Funds be provided for fencing the area and initial wildlife development. The mitigation area should be deeded to and managed by the City of Wichita Falls as a natural area or greenbelt.
4. Vegetation planted on the embankment as well as revegetation of areas disturbed by construction be native species with known food value for wildlife.
5. The bank immediately downstream of the outlet discharge and spillway be protected to prevent bank erosion and channel scouring.
6. Changes in the design/operation of the project be considered that would enhance waterfowl and other waterbird habitat by creating shallow water (wetland) areas in the detention site. Modifications to the design of the borrow area should be considered that will provide irregular shape, gently sloping to a deep water area, and islands of unexcavated grassland. Providing a water source to the borrow area (through the diversion ditch or by drainage) should be a part of this plan.

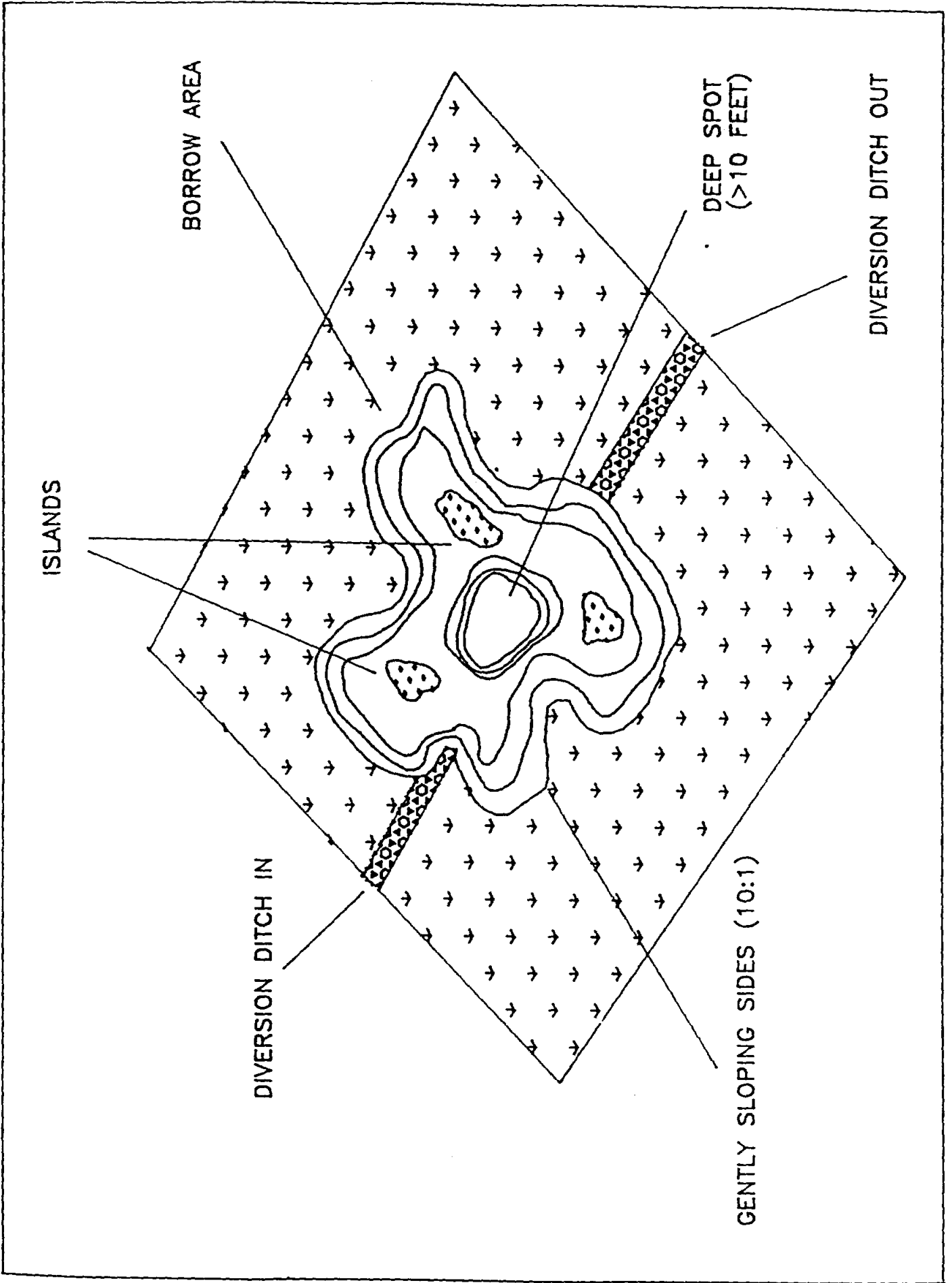

Figure 3. General concept for borrow area wetland design.

## SUMMARY AND POSITION OF THE SERVICE

Construction of a detention structure on the main branch of Plum Creek will have an impact on two habitat types, mesquite grasslands and riparian timber, due to construction of the embankment, borrow sites, and an access road. The most valuable habitat type in the Plum Creek study area is riparian timber. Riparian areas provide cover, food, water and shade for wildlife, and water quality enhancement for man. A considerable amount of wildlife impacts can be avoided by not clearing vegetation in the detention site and locating borrow sites and roads away from riparian timber areas. Mitigation of unavoidable riparian timber losses can be accomplished through the acquisition of about 14 acres of downstream riparian habitat and management of this area as a greenbelt by the City of Wichita Falls. Creation of a shallow water wetland area within the flowage easement would enhance waterfowl/waterbird habitat and contribute towards the goals of the North American Waterfowl Management Plan. Mitigation requirements for the 75-acre borrow site will depend on the habitat at the selected site.

To ensure that full consideration is given to fish and wildlife needs, we request that the Corps address in the Definite Project Report the recommendations in this report. Please indicate acceptance or rejection of each recommendation, justification for any rejections, and how the Corps and/or City will incorporate our recommendations into the project.

We appreciate the opportunity to be involved in planning for the proposed Plum Creek Flood Protection Project. This report is based on information provided before September 1991, and is subject to revision should plans be modified or more detailed studies be required.





TEXAS  
PARKS AND WILDLIFE DEPARTMENT  
4200 Smith School Road • Austin, Texas 78744 • 512-389-4800

ANDREW SANSOM  
Executive Director

COMMISSIONERS

YGNACIO D. GARZA  
Chairman, Brownsville

JOHN WILSON KELSEY  
Vice-Chairman  
Houston

LEE M. BASS  
Ft. Worth

HENRY C. BECK, III  
Dallas

TERESE TARLTON HERSHEY  
Houston

GEORGE C. "TIM" HIXON  
San Antonio

CHUCK NASH  
San Marcos

BEATRICE CARR PICKENS  
Dallas

WALTER UMPHREY  
Beaumont

November 1, 1991

Mr. Stephen W. Forsythe  
Field Supervisor  
U.S. Fish and Wildlife Service  
Ecological Services  
222 South Houston, Suite A  
Tulsa, Oklahoma 74127

Re: Fish and Wildlife Service Draft Coordination  
Act Report -- Plum Creek Flood Protection  
Project, Wichita County, Texas

Dear Mr. Forsythe:

The above referenced report transmitted by your letter of September 24, 1991 has been reviewed by Department staff and the following comments are provided.

A search of the Texas Natural Heritage Program Information System revealed Dipodomys elator (Texas Kangaroo Rat), federal category 2 and state threatened, from the general area. A printout and code key are attached. It should be noted that the kangaroo rat does not require mesquite to be present and is known to occur in areas without mesquite.

The Heritage Program information included here is based on the best data currently available to the state regarding threatened, endangered, or otherwise sensitive species. However, these data do not provide a definite statement as to the presence or absence of special species or natural communities within your project area, nor can these data substitute for an evaluation by qualified biologists. This information is intended to assist you in avoiding harm to species that occur on your site. Please contact the Texas Parks and Wildlife Department's Heritage Program before publishing or otherwise disseminating any specific locality information.

TEXAS NATURAL HERITAGE PROGRAM  
TEXAS PARKS AND WILDLIFE DEPARTMENT  
16 OCT 1991

NAME: DIPODOMYS ELATOR

COMMON NAME: TEXAS KANGAROO RAT

OTHER NAME:

FEDERAL STATUS: C2

STATE STATUS: T

GLOBAL RANK: G2

STATE RANK: S2

IDENTIFIED: Y

TRACK: Y

SENSITIVITY: N

COUNTY: Wichita

USGS TOPO MAPS:

TOPO QUAD:

MARGIN #:

CLARA

3409816

1

BURKBURNETT

3409815

SUNSHINE HILL

3409817

ELECTRA

3409818

FOWLKES

3309887

IOWA PARK

3309886

WICHITA FALLS WEST

3309885

ELEMENT OCCURRENCE NUMBER: 019

DATE LAST OBSERVED: 1985-03-10

PRECISION: S

DATE FIRST OBSERVED: 1966

OCCURRENCE RANK:

DATE SURVEYED: 1985-03-10

SURVEY COMMENTS: FIELD VISIT TO VICINITY YIELDED RATS

MANAGED AREAS:

DIRECTIONS:

AN AREA NORTHWEST OF WICHITA FALLS, NORTH OF IOWA PARK, NE OF ELECTRA.  
BOUND BY S.R. 240, HWY 287, & HWY 281-277.

DESCRIPTION:

CLAY SOILS WITH SPARSE GRASS AND SMALL MESQUITE. BURROWS ARE USUALLY  
AT BASE OF MESQUITE.

QUALITATIVE/QUANTITATIVE DATA:

A LARGE K-RAT WITH LONG TAIL WITH CONSPICUOUS WHITE BANNER TIP.  
RESTRICTED TO SMALL AREA OF OKLAHOMA AND TEXAS. NOT COMMON. PATCHY  
DISTRIBUTION.

MANAGEMENT COMMENTS:

BRUSH CONTROL MAY THREATEN.

PROTECTION COMMENTS:

OTHER COMMENTS:

A COMPILATION OF 40 SPECIMEN RECORDS. SEE EL-FILE FOR EXACT LOCATIONS,  
DATES AND MUSEUMS.

SOURCE OF INFORMATION:

BEST, TROY. DEPARTMENT OF BIOLOGY, UNIVERSITY OF NEW MEXICO  
ALBUQUERQUE, NEW MEXICO. PH-505/277-5971.

## CODE KEY

### FEDERAL STATUS

- LE - Listed Endangered
- LT - Listed Threatened
- LELT - Listed Endangered in part of range, Threatened in a different part
- PE - Proposed to be listed Endangered
- PT - Proposed to be listed Threatened
- PEPT - Proposed Endangered, Threatened
- S - Synonyms
- C1 - Candidate, Category 1. USFWS has substantial information on biological vulnerability and threats to support proposing to list as endangered or threatened. Data are being gathered on habitat needs and/or critical habitat designations.
- C1\* - C1, but lacking known occurrences
- C1\*\* - C1, but lacking known occurrences, except in captivity/cultivation
- C2 - Candidate, Category 2. Information indicates that proposing to list as endangered or threatened is possibly appropriate, but substantial data on biological vulnerability and threats are not currently known to support the immediate preparation of rules. Further biological research and field study will be necessary to ascertain the status and/or taxonomic validity of the taxa in Category 2.
- C2\* - C2, but lacking known occurrences
- C2\*\* - C2, but lacking known occurrences, except in captivity/cultivation
- 3 - Taxa no longer being considered for listing as threatened or endangered. Three subcategories indicate the reasons for removal from consideration.
- 3A - Former Candidate, rejected because presumed extinct and/or habitats destroyed
- 3B - Former Candidate, rejected because not a recognized taxon; i.e. synonym or hybrid
- 3C - Former Candidate, rejected because more common, widespread, or adequately protected
- blank - Not currently listed

### STATE STATUS

- E - Listed as Endangered in the State of Texas
- T - Listed as Threatened in the State of Texas
- blank - Not currently listed

TULSA DISTRICT RESPONSE TO  
U.S. FISH AND WILDLIFE SERVICE  
MITIGATION RECOMMENDATIONS

In accordance with the Fish and Wildlife Coordination Act (48 Stat. 401, as amended; 16 U.S.C. 661, et seq.), the U.S. Fish and Wildlife Service provided a Coordination Act Report dated February 1992 that addresses the fish and wildlife resources to be affected by the Plum Creek flood control project. A copy of the report is included in Appendix 6. Tulsa District's response to their comments follows:

Comment 1. Vegetation (especially riparian timber) within the detention site will not be cleared as a result of project construction and that the flowage easement agreement contain restrictions or specifications prohibiting vegetation clearing after construction.

Response. Clearing of timber within the detention site will be limited to the areas necessary for construction of the embankment, spillway, access roads, and borrow areas. Easements for the right to flood the detention site will be obtained for the project. Additional restriction of this land to prevent possible clearing in the future would represent a mitigation feature and would require additional justification. A mitigation plan has been developed to mitigate for defined habitat losses attributable to the project. To mitigate for possible future losses (clearing of the detention basin by the landowner) would be difficult to quantify and justify. The detention basin is currently used for grazing, which is considered to be the highest and best use of the area. Since this area will be subject to flooding, it is doubtful that land use activities will change in the future as a result of the project. Consequently, we cannot recommend placing additional restrictions on the easements associated with the project.

Comment 2. Borrow areas and access/work roads needed to construct and maintain the project be located away from riparian areas.

Response. Concur. Work in these areas will be limited to construction of the embankment, spillway, access road, and borrow areas. If borrow material is near a riparian zone, borrow areas will be kept a minimum of 100 feet back from the stream edges to ensure the integrity of the riparian zones.

Comment 3. A 14-acre riparian habitat mitigation area be established along Plum Creek downstream of the detention pond. Funds be provided for fencing the area and for initial wildlife development. The mitigation area should be deeded to and managed by the city of Wichita Falls as a natural area or greenbelt.

Response. The most cost effective plan per Average Annual Habitat Unit (AAHU) is Plan A3, which is essentially the U.S. Fish and Wildlife recommendation.

Comment 4. Vegetation planted on the embankment as well as revegetation of areas disturbed by construction be native species with known food value for wildlife.

Response. Concur. These areas will be reseeded to native grasses of value to wildlife.

Comment 5. The bank immediately downstream of the outlet discharge and spillway be protected to prevent bank erosion and channel scouring.

Response. Concur. The outlet structure has been designed with riprap protection to prevent erosion.

Comment 6. Changes in the design/operation of the project be considered that would enhance waterfowl and other water bird habitat by creating shallow water (wetland) areas in the detention site. Modifications to the design of the borrow area should be considered that will provide irregular shape, gently sloping to a deep water area, and islands of unexcavated grassland. Providing a water source to the borrow area (through the diversion ditch or by drainage) should be a part of this plan.

Response. Concur. Borrow areas and the proposed drainage ditch upstream of the structure will be designed to create the types of wetlands requested. The borrow areas will be left in irregular shapes to the extent possible, and consideration will be given to leaving the desired islands for waterfowl.

**MITIGATION PLAN  
PLUM CREEK FLOOD CONTROL PROJECT**

1. The proposed plan consists of a detention structure with an earthen embankment about 3,100 feet long located on the main branch of Plum Creek, 0.5 mile north of U.S. 287 near Wichita Falls, Texas. A 165-foot-wide emergency spillway would be constructed at elevation 1002 to allow passage of the Probable Maximum Flood. A diversion ditch approximately 1,600 feet long would be constructed north of the embankment to divert flows from an east tributary into Plum Creek.

At maximum pool, the project would inundate about 330 acres. It would require an estimated 7 to 10 days to drain the detention pool after major flood events.

Land requirements for the project include approximately 52.4 acres in fee for the damsite, spillway, and drainage channel; an easement on 1.3 acres for an access road; and flowage easements on 262.5 acres that could be inundated during maximum flows. A flowage easement on 7.8 acres from the toe of the spillway to the existing channel would be required for hydrologic safety because the velocity of the flow from the toe of the spillway would increase due to modified conditions.

Additional flowage and borrow easements would be needed on about 51.5 acres behind the damsite for the detention and borrow area.

2. Significant Resources. The project is situated in the mesquite/buffalo grass section of the prairie brushland ecoregion (Bailey 1980). Due to urban development in the lower part of the basin, the best remaining wildlife habitat would be located along riparian zones and mesquite grasslands in the upper segment of the creek and in the project area.

3. Resource Category Determination. The U.S. Fish and Wildlife Service's Mitigation Policy (Federal Register 46 [15]: 7644-7663) provides guidance for formulation of measures to offset project impacts on habitat value. Species used to evaluate the riparian habitat of Plum Creek included migrating and nesting songbirds and small mammals, such as fox squirrels and raccoons. It was determined that the riparian habitat of Plum Creek is of medium value for the evaluation species and that riparian habitat is relatively abundant on a national basis. The Service's mitigation goal for riparian habitat is no net loss of habitat value while minimizing loss of in-kind habitat value. Mesquite grasslands in the site possess medium to low habitat value for evaluation species and are abundant within the project area. The mitigation goal for mesquite grasslands is to minimize loss of habitat value.

4. Mitigation Planning Objectives. Mitigation planning objectives consisted of several components, which included avoidance, minimization of impacts, restoration, and compensation.

a. Avoidance. Relocating the embankment upstream of the proposed site to avoid a riparian zone containing 4 acres of riparian timber was considered, but was not feasible due to costs that would be incurred from relocating existing high voltage transmission lines. Additional impacts of borrow areas on riparian zones will be avoided by keeping borrow areas at least 100 feet from the edge of the creek.

b. Minimization of Impacts. Impacts to the mesquite grassland complex will be minimized by limiting clearing within the detention pond to only those areas needed to construct the embankment and spillway. The remainder of the detention pond will be left uncleared.

c. Restoration. Disturbed areas within the site and the embankment will be reseeded to native grass species and maintained in a manner conducive to wildlife. Borrow areas will be shaped to hold water and provide benefits to waterfowl.

d. Compensation. To ensure no net loss of habitat value for riparian habitats, development of a 14-acre mitigation area immediately downstream of the embankment is proposed.

5. Habitat Evaluation. The most direct impacts on wildlife resources would occur from loss of habitat due to construction of the detention embankment, the borrow sites, and the access road. Approximately 4 acres of riparian timber and 19.5 acres of mesquite grasslands would be impacted. About 75 acres of mesquite grasslands would be impacted by borrow sites, and approximately 40 acres of riparian habitat along the creeks upstream of the embankment would be affected by flood control operations.

Construction of the detention embankment and access road will result in the loss of about 4 acres of riparian timber and 8 acres of mesquite grasslands. About 75 acres of unknown habitat will be affected at the borrow sites. Since the U.S. Fish and Wildlife Service is seeking compensation only for loss of riparian timber, Habitat Evaluation Procedures (HEP) apply to riparian timber only. The U.S. Fish and Wildlife Service, using an abbreviated HEP, determined that the Habitat Suitability Index (HSI) for riparian timber in the project area was .45 on a scale of 0 to 1.0. Since 4 acres would be lost, the Average Annual Habitat Unit (AAHU) that would be lost is 1.8 Habitat Unit Value (Area x HSI) (See Table 1). Construction of the Plum Creek detention project will result in an annual net loss of 1.79 habitat units over the 50-year project life. To mitigate this loss, a 14.5-acre mitigation area will be required, according to the U.S. Fish and Wildlife Service.

TABLE 1  
RESULTS OF HEP ON RIPARIAN TIMBER  
IN THE PLUM CREEK FLOOD PROTECTION PROJECT

Target Year	Without Project			With Project		
	Area (acres)	HSI	HUV <sup>1</sup>	Area (acres)	HSI	HUV <sup>1</sup>
0 <sup>2</sup>	4	0.45	1.8	4	0.45	1.8
1 <sup>3</sup>	4	0.45	1.8	0	0	0
25	4	0.45	1.8	0	0	0
50	4	0.45	1.8	0	0	0

Average Annual Habitat Units (AAHU) without project = 1.8

Average Annual Habitat Units (AAHU) with project = 0.01

Net change in AAHU over life of the project = -1.79

Area needed for compensation = 14.5 acres

1 Habitat Unit Value (HEV) = Area x HSI

2 Target Year 0 = baseline (existing) conditions

3 Target Year 1 = end of project construction

### Mitigation Analysis

Several alternative mitigation plans were initially considered. A riparian zone mitigation site located in the upper reaches of the detention pool was considered, but was dropped from further consideration because flood control operation of the detention structure would not allow development of a riparian zone. Mitigation of riparian losses on other public lands near the project area was also considered, but no other public lands were found near the project area that could be developed for mitigation.

Suitable lands for mitigation were found to exist along the creek immediately below the dam. This area, which contains a riparian zone along the creek mixed with riparian timber, possesses management potential for mitigation. Consequently, it was decided to fully explore the mitigation options associated with developing lands immediately downstream of the embankment for a mitigation area.

Consistent with guidance contained in Engineer Regulation 1105-2-100, dated 28 December 1990, Subject: Guidance for Conducting Civil Works Planning Studies, an incremental cost analysis was conducted for the proposed mitigation plan. A total



of nine mitigation alternatives were considered in the final mitigation analysis (Tables 2 and 3). Three alternative plans of development with two levels of management for each plan were investigated.

### **Evaluation of Alternative Plans**

Three basic alternative plans, A, B, and C, were evaluated to mitigate the loss of about 4 acres of riparian timber. The proposed mitigation area is located immediately downstream of the detention embankment, as shown in Figure 6-1. For analytical purposes, this area is divided into four major segments or areas based, in part, on land ownership. There are 8 acres in Area 1, 3 acres in Area 2, 10 acres in Area 3, and 3 acres in Area 4. The loss of 4 acres of riparian timber would be mitigated by acquiring, in fee, about 14.5 acres of existing riparian habitat. The preferable acquisition would be a continuous tract of land on both sides of Plum Creek downstream of the detention structure. The U.S. Fish and Wildlife Service estimates that about 5.74 AAHU are required for mitigation of the losses.

Plan A1 would require the purchase of Areas 1, 2, 3, and 4; a total of 24 acres. Area 3, consisting of 10 acres, is included since it would be inaccessible to existing landowners otherwise. No habitat units are attached to Area 3. Plan A2 would require purchase and fencing. Plan A3 would require purchase, fencing, and development, such as the posting of signs and other management practices. Plan A3 is essentially the U.S. Fish and Wildlife Service mitigation plan except for the inclusion of Area 3 and refinement of the costs of fencing and development, including some plantings.

Plan B1 includes the purchase of all of Areas 1, 3, and 4, and about half of Area 2, split by the fence line where a new ownership would occur, for a total of 23 acres. Thirteen acres have habitat units. Estimated acquisition costs per ownership are estimated to be about \$7,000. Plan B2 includes purchase in fee and fencing. Plan B3 adds management and development.

Plan C1 is to purchase the land in Areas 1, 2, and 3, a total of 21 acres. Plan C2 is the same as Plan C1, but includes fencing; Plan C3 includes development.

Other possible combinations of alternatives were eliminated from further consideration since they were unworkable. For example, Areas 1, 2, and 4 are not workable since Area 3 would be inaccessible.

Each alternative was evaluated in terms of habitat potential. The combination of areas for each plan are shown in Table 2 with the associated implementation costs.

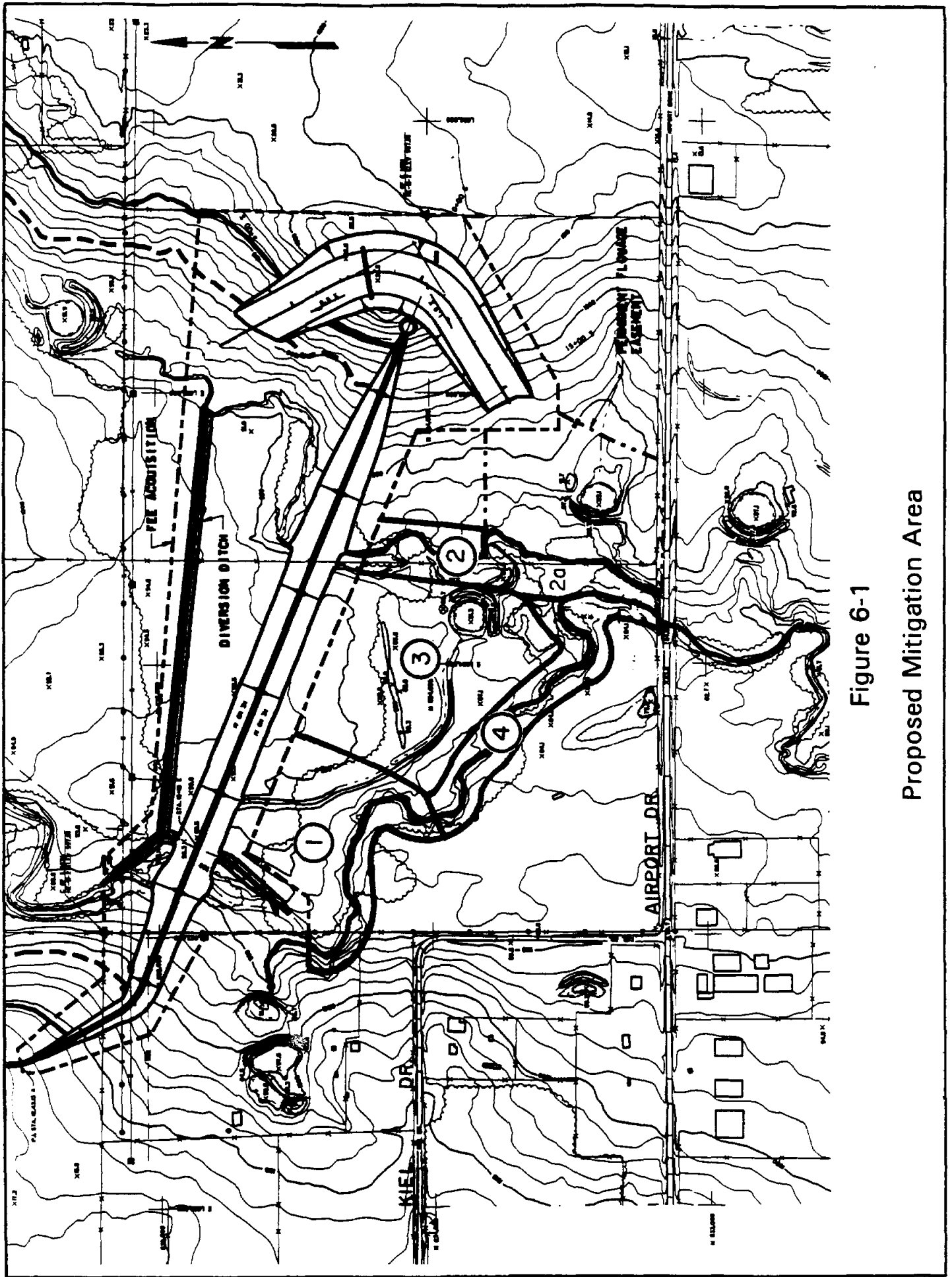

Figure 6-1

Proposed Mitigation Area

TABLE 2  
ALTERNATIVE PLAN COSTS

Plan	Area	Total Acres	Land (\$)	Fencing Cost (\$)	Development (\$)	Total (\$)
A1	1+2+3+4	24	8,760	0	0	8,760
A2	1+2+3+4	24	8,760	9,675	0	18,435
A3	1+2+3+4	24	8,760	9,675	6,040	24,475
B1	1+2A+3+4	23	8,395	0	0	8,395
B2	1+2A+3+4	23	8,395	9,100	0	17,495
B3	1+2A+3+4	23	8,395	9,100	6,040	23,535
C1	1+2+3	21	7,665	0	0	7,665
C2	1+2+3	21	7,665	8,975	0	16,640
C3	1+2+3	21	7,665	8,975	6,040	22,680

The incremental analysis for the alternative plans is shown in Table 3.

TABLE 3  
INCREMENTAL ANALYSIS FOR PLAN ALTERNATIVES

Plan	Cum. AAHU	Incremental AAHU	Cum. Cost (\$)	Avg. Annl. Cost (\$)	Avg. Annl. Cum. Cost Per AAHU (\$)	Incremental Cost (\$)	Incremental Cost Per AAHU (\$)
No Action	0	0	0	0	0	0	0
A1	6.3	6.3	8,760	757	120	757	120
A2	12.7	6.4	18,435	1,594	249	837	131
A3	19.1	6.4	24,475	2,116	331	522	82
B1	5.9	5.9	8,395	726	123	726	123
B2	11.9	6.0	17,495	1,513	252	787	131
B3	17.9	6.0	23,535	2,035	302	522	87
C1	5.0	5.0	7,665	663	133	663	133
C2	10.1	5.1	16,640	1,439	282	776	152
C3	15.2	5.1	22,680	1,961	385	522	102

## Results

A total of nine mitigation options were considered in detail. The only remaining riparian timber of suitable value is immediately downstream of the project. Because of land ownership boundaries within the proposed mitigation area, it was necessary to purchase Parcel 3 (Figure 6-1) in order to obtain the necessary riparian areas required for mitigation. Parcel 3 contains limited riparian resources and is composed primarily of mesquite grassland. It is to be purchased only because it would become inaccessible to the adjacent landowner(s) if it were not purchased. Consequently, all options exceed the land requirements for mitigation (14.5 acres) as determined by the habitat based evaluation. Land costs for Parcel 3 are included in all alternatives for comparative purposes.

Plans A1, B1, and C1 were included in the analysis, but are not viable alternatives because they do not include costs for fencing. Without fencing included as a component of the plan, management of the area for riparian timber would not be possible. As shown in Table 3, the most cost effective plan per AAHU that meets the established mitigation goals is Plan A3. Options A2, B2, B3, C2, and C3 were not as cost effective per AAHU as Plan A3.

The land purchase itself would not be enough to compensate for the loss of riparian habitat over the life of the project. Therefore, to effectively mitigate for this loss, fencing, posting of signs, and minimal development will be incorporated into the plan. Tree plantings will be composed of a mixture of evergreen and hardwood trees and shrubs. The exact number and locations of plantings would be determined during plans and specifications and would be based upon existing habitat at the time of plantings. It is anticipated that about two hundred 5- to 6-foot-tall trees would be needed to improve the value of the existing riparian timber.

# APPENDIX 7 - FINANCIAL CAPABILITY ANALYSIS

APPENDIX 7

FINANCIAL CAPABILITY ANALYSIS

TABLE OF CONTENTS

	<u>Page</u>
INTRODUCTION . . . . .	7- 1
DEBT HISTORY . . . . .	7- 1
Bond Ratings . . . . .	7- 1
Existing Debt . . . . .	7- 2
Debt Repayment . . . . .	7- 3
FINANCIAL CONDITION . . . . .	7- 6
Annual Rate of Change in Population . . . . .	7- 7
Surplus or Deficit in Operating Budget . . . . .	7- 7
Property Tax Collection Rate . . . . .	7- 9
Reliance on Property Tax Revenues . . . . .	7- 9
Sales Tax Revenue . . . . .	7- 9
Potential Debt Capacity . . . . .	7-10
CONCLUSION . . . . .	7-11

Tables

7-1 Long-Term Debt . . . . .	7- 2
7-2 Bonds Payable . . . . .	7- 3
7-3 Repayment Schedule . . . . .	7- 3
7-4 Overlapping Net Debt . . . . .	7- 4
7-5 Other Debt . . . . .	7- 4
7-6 Future Debt For Capital Improvements . . . . .	7- 5
7-7 Overall Debt . . . . .	7- 6
7-8 General Fund . . . . .	7- 8
7-9 Financial Indicator Ratings . . . . .	7-11

## APPENDIX 7

### FINANCIAL CAPABILITY ANALYSIS

#### INTRODUCTION

The purpose of this analysis is to determine the capability of the city of Wichita Falls, Texas, to finance the non-Federal portion of the Plum Creek flood protection project. The selected plan is an upstream detention reservoir designed to provide 100-year sediment storage and flood control protection somewhere between the 25- and the 50-year events. The total non-Federal costs for the detention reservoir are about \$600,000 based on costs estimated in the feasibility phase of the Plum Creek study.

A number of interrelated economic, fiscal, and management factors support a local government's capacity to finance desired capital improvement projects. Those factors include the health of the local economy, the structure of its revenue base, the management of the community's operations, and the debt history of the community. The Municipal Fiscal Officers Association with Peat, Marwick, and Mitchell Company has developed a number of financial warning indicators useful in determining the financial health of a community. These indicators are helpful in determining the sponsor's current debt position and financial condition. Financial indicator ratings, as discussed in subsequent sections, are calculated for the city of Wichita Falls and are compared to national averages as outlined in the Environmental Protection Agency's Financial Capability Guidebook, dated March 1984. The financial data used to calculate these ratings were obtained from The City of Wichita Falls, Texas, Comprehensive Annual Financial Report, For The Year Ended September 30, 1990.

#### DEBT HISTORY

A review of the city's debt history is useful in calculating certain financial indicators. Bond ratings, outstanding debt, and debt repayment are used in determining whether the community can incur additional debt.

#### Bond Ratings

The city of Wichita Falls received the following bond ratings for the 1989-90 fiscal year:

	<u>Moody's Investors Service</u>	<u>Standard &amp; Poor's</u>
General Obligation Bonds	A1	AA
Revenue Bonds	A1	A+

Moody's A1 rating is defined as the highest A rating and it possesses many favorable investment attributes. Bonds with this rating are considered to be upper medium grade obligations. Interest and principal are considered secure, but could be susceptible to future conditions. Standard & Poor's AA rating only differs from their highest rating by a small degree and indicates a very strong capacity to pay interest and repay principal. A+ is the highest A rating and is somewhat more susceptible to adverse effects of changes in circumstances and economic conditions. These ratings are reasonable and healthy for cities the size of Wichita Falls.

**Existing Debt**

Wichita Falls has outstanding general obligation (GO) bonds dating back to 1986. These bonds are backed by the full faith and credit of the city, and are serviced by the Debt Service Fund which is secured with real property taxes. Revenue bonds were issued in 1986 and in 1990 for the purpose of improving the city's water and sewer systems. The revenue bonds are serviced by the net revenues of the Water and Sewer Fund. Because these revenue bonds are self-supporting, they are not counted as a part of the city's total indebtedness. As of September 30, 1990, the city had \$20,325,000 in GO bonds and \$24,826,401 in revenue bonds outstanding. The city of Wichita Falls reduced its total long-term debt by \$1,356,074 during the 1990 fiscal year. Table 7-1 outlines the long-term debt obligations of the city for the year ended September 30, 1990.

TABLE 7-1

LONG-TERM DEBT

Source	Obligations Outstanding October 1, 1989 (\$)	New Obligations Incurred (\$)	Obligations Retired or Refunded (\$)	Obligations Outstanding September 30, 1990 (\$)
GO Bonds	20,995,000	-	670,000	20,325,000
Revenue Bonds	22,835,000	2,631,401	640,000	24,826,401
Vacation & Sick Leave	3,084,558	162,187	-	3,246,745
Capital Leases	86,455	-	19,829	66,626
Claims & Judgements	97,664	-	9,828	87,836
U.S. Government	<u>1,093,040</u>		<u>16,417</u>	<u>1,076,623</u>
Total	48,191,717	2,793,588	1,356,074	49,629,231

Vacation & sick leave, capital leases, claims & judgements, and obligations to the U.S. Government fall under the category of other debt which will be discussed further in subsequent paragraphs.



Bonds outstanding as of September 30, 1990, are shown in Table 7-2.

TABLE 7-2  
BONDS PAYABLE

Bonds	Interest Rates (%)	Range of Maturity Date	Final Serial Payments (\$)	Annual Bonds Authorized (\$)	Bonds Outstanding September 30, 1989 (\$)
1986 GO Bonds	5-8.15	9/01/06	305,000- 2,115,000	22,540,000	20,325,000
1986 Revenue Bonds	5-8.30	8/01/07	395,000- 2,265,000	24,405,000	22,195,000
1990 Revenue Bonds	5-7.72	8/01/00	146,401- 415,000	<u>26,210,000</u>	<u>2,631,401</u>
Total All Bonds				73,155,000	45,151,401

**Debt Repayment**

The annual repayment schedule for GO serial bonds as of September 30, 1990, is listed in Table 7-3.

TABLE 7-3  
REPAYMENT SCHEDULE

Year Ending September 30	General Obligation		Total (\$)
	Principal (\$)	Interest (\$)	
1991	710,000	1,575,615	2,285,615
1992	755,000	1,531,240	2,286,240
1993	805,000	1,482,165	2,287,165
1994	860,000	1,427,827	2,287,827
1995	<u>920,000</u>	<u>1,367,627</u>	<u>2,287,627</u>
Total	4,050,000	7,384,474	11,434,474

Thirty percent of the city's GO bonds outstanding are due within the next 5 years. The percentage of debt coming due during the next 5 years indicates that the city has already committed a large portion of future revenues for debt service, but has room for future financial growth. The city's debt limit is governed by the

city's ability to levy and collect taxes to service outstanding indebtedness. The city's maximum legal tax rate established under its charter is \$2.25 per \$100 assessed valuation. The 1989 tax rate was \$.6479 per \$100 assessed valuation. Wichita Falls is using 29% of its debt limit.

Table 7-4 shows the city's overlapping net debt. The overlapping net debt shows the tax-supported debt of local governmental units located wholly or partially within the Wichita Falls city limits for which the city is responsible.

TABLE 7-4

OVERLAPPING NET DEBT  
(September 30, 1990)

Taxing Jurisdiction	Gross Bonded Debt Outstanding (\$)	Percentage Applicable to city of Wichita Falls (%)	Amount Applicable to city of Wichita Falls (\$)
Wichita Falls Independent School District	19,185,000	98.49	18,895,307
Wichita County City View Independent School District	2,185,000	77.23	1,687,476
Burkburnett Independent School District	655,000	75.25	492,887
	<u>8,235,000</u>	1.16	<u>95,526</u>
Total Overlapping Debt	30,260,000		21,171,196

A complete evaluation of Wichita Falls's debt load should include the city's other debt not previously counted in other categories. A description of Wichita Falls's other debt is listed in Table 7-5.

TABLE 7-5

OTHER DEBT  
(September 30, 1990)

Accrued Vacation & Sick Leave	\$ 3,246,745
Leases Payable	66,626
Claims & Judgements	87,836
U.S. Government	1,076,623
Unfunded Pension Obligation	<u>7,754,535</u>
Total	\$12,232,365

Another important debt category is the amount of future debt for other planned capital improvements. The city has committed to several long-term construction contracts, but does not incur any expenses until the work has been performed. The amounts for which the various funds are committed to complete these contracts as of September 30, 1990, are shown in Table 7-6.

TABLE 7-6  
FUTURE DEBT FOR CAPITAL IMPROVEMENTS

Source	Funds (\$)	Amount Committed (\$)
General Fund		660,635
Special Revenue Fund:		
Community Development Block Grant Fund	12,860	
Miscellaneous Special Revenue Fund	<u>36,871</u>	
Total Special Revenue Fund		49,731
Capital Projects Fund:		
1980 General Improvements	404,853	
1981 C.O. General Improvements	359,200	
1981 G.O. General Improvements	1,524,000	
1982 General Improvements	462,150	
1985 Holliday Creek Project	<u>2,452,554</u>	
Total Capital Projects Fund		5,202,757
Enterprise Fund:		
Sanitation Fund	334,672	
Water and Sewer Fund	<u>1,996,915</u>	
Total Enterprise Fund		<u>2,331,587</u>
Total Contract Commitments		8,244,710

The city's overall debt position is summarized in Table 7-7.

TABLE 7-7  
OVERALL DEBT

	Outstanding Debt (\$)
General Obligation Bonds	20,325,000
Revenue Bonds	24,826,401
Non-Federal Project Cost	<u>600,000</u>
Gross Direct Debt	45,751,401
Direct Net Debt	20,925,000
Overlapping Net Debt	21,171,196
Overall Net Debt	42,096,196
Other Debt	12,232,365
New Debt for Other Capital Improvements	8,244,710

The gross direct debt is the sum of the total amount of general obligation bonds, revenue bonds outstanding, and the new debt for the Plum Creek Project. The direct net debt is the gross direct debt less the self-supporting debt (revenue bonds). The overall net debt is the sum of direct net debt and overlapping debt.

**FINANCIAL CONDITION**

The financial condition of the city of Wichita Falls depends, in part, on the strength of the local economy, not only in the city proper, but also in Wichita County. Economic and financial structures are connected through the community's revenue structure and expenditure choices. Economic resources pass through the revenue system producing financial resources. Financial indicators are calculated to assess Wichita Falls's financial and economic condition. These indicators were analyzed in conjunction with other relevant information to determine the economic strength of the community. The key indicators are divided in these categories: annual rate of change in population; surplus or deficit in operating budget; property tax collection rate; reliance on property tax revenues; sales tax revenues; and potential debt capacity.

### **Annual Rate of Change in Population**

The 1990 Census of Population showed that 96,259 people reside in Wichita Falls. The city has experienced little growth in the last 10 years. The 1980 population of Wichita Falls was 94,201. Between 1980 and 1990, the city grew by less than 1%. The annual rate of change in population was .22% from 1980 to 1990. The annual rate of change in population is important because the economic base of the community is typically dependent on personal income, retail sales, and the market value of real property, all of which rise and fall with changes in population. An annual rate of population change between negative 1% and 1% is an average financial indicator rating.

### **Surplus or Deficit in Operating Budget**

The Combined Statement of Revenues, Expenditures, and Changes in Fund Balance for the General Fund shows that the total current revenue in the 1990 fiscal year was \$28,543,498. Total current general fund expenditures were \$28,874,890. Table 7-8 is a summary of the Combined Statement showing the breakdown of these revenues and expenditures.<sup>1</sup>

---

<sup>1</sup>City of Wichita Falls, Texas Comprehensive Annual Financial Report For the Year Ended September 30, 1990, Exhibit A-2, p. 5.

TABLE 7-8  
GENERAL FUND  
(Year Ended December 31, 1990)

	Actual (\$)
<b>Revenues</b>	
Taxes	23,736,091
Charges for Services	1,234,406
Licenses and Permits	440,088
Fines	900,404
Intergovernmental Revenue	779,466
Miscellaneous Revenues	<u>1,453,043</u>
<b>Total Revenues</b>	<b>28,543,498</b>
<b>Expenditures (Current):</b>	
Administrative Services Division	4,655,580
Police Division	8,359,078
Fire Division	5,360,935
Parks and Recreation Division	2,388,480
Accounting/Finance Division	428,310
Planning Division	326,867
Public Works Division	4,224,499
Health Division	1,933,354
Traffic and Transportation Division	<u>1,197,787</u>
<b>Total Expenditures</b>	<b>28,874,890</b>
<b>Revenues Over (Under) Expenditures</b>	<b>(331,392)</b>
<b>Other Financing Sources</b>	
Operating Transfers In	950,541
Operating Transfers Out	(213,515)
<b>Total Other Financing Sources</b>	<b>737,026</b>
<b>Excess of Revenues and Other Sources Over (Under) Expenditures and Other Uses</b>	<b>405,634</b>

For the 1990 fiscal year, there was an excess of \$405,634 of revenues and other sources over expenditures. The current operating surplus as a percentage of total expenditures was 1.4%. This is an average indicator rating. A positive percentage is a healthy sign. Wichita Falls has had an operating surplus each year over the last 3 years.

### Property Tax Collection Rate

The real property tax collection rate is an indicator of the efficiency of the tax collection system. The collection rate is calculated by dividing the current property taxes collected in the most recent tax year by the property taxes levied in the same year. The 1990 property tax collection rate was calculated as follows:

$$\frac{\text{1990 property taxes collected}}{\text{1990 property taxes levied}} = \frac{\$14,515,449}{\$14,896,248} \times 100 = 97.44$$

The real property tax collection rate for 1990 was 97.44%. A tax collection rate between 96 and 98% indicates an average rating and an efficient tax collection system.

### Reliance on Property Tax Revenues

The ability of a community to sustain and raise current tax levels provides an indication of the potential for revenue growth from tax sources. To withstand changes in external conditions which affect tax revenues, such as reliance on other revenue sources, i.e., intergovernmental grants, a community should have room for growth in its tax revenue sources. The current assessment ratio is 100% of market value. Total assessed value of property was about \$1.8 billion in 1990. Since the assessment ratio is 100%, the full market value of real property is \$1,789,161,491, the same as the total assessed value of property. Property tax revenues as a percentage of the full market value of real property shows the extent to which a community is taxing real property. The percentage is calculated as follows:

$$\frac{\text{1990 Property Tax Revenues}}{\text{Full Market Value of Real Property}} = \frac{\$23,736,091}{\$1,789,161,491} \times 100 = 1.3$$

A value below 2% is a strong financial rating and indicates that real property may not be taxed extensively, and the potential for future revenue growth from property taxes may exist.

### Sales Tax Revenue

Employment conditions affect the city's sales tax revenue. Wichita Falls is located in Wichita County, Texas. The five largest categories of employment in Wichita County are government, services, retail trade, manufacturing, and transportation and other public utilities. There are 17,184 government employees in the county and 11,098 employees in the services category. Wichita Falls has a large public sector with Midwestern State University and Sheppard Air Force Base being two of the largest employers in the Metropolitan Statistical Area. Wichita Falls has a 1 cent sales tax.

### Potential Debt Capacity

To determine whether a community can support additional borrowing, it is useful to compare the amount of tax-supported debt owed to the full market value of real property. Overall net debt as a percentage of full market value of real property is calculated as follows:

$$\frac{\text{Overall net debt}}{\text{Market value of real property}} = \frac{\$ 42,096,196}{1,789,161,491} \times 100 = 2.4$$

Below 3% is a strong rating indicating that Wichita Falls can support the additional debt of the proposed project.

In 1990, per capita income for Wichita Falls was \$14,930. Total personal income (population times per capita income) for 1990 was \$1,437,146,870. Personal income is a measurement of a community's wealth and can be used to determine the community's ability to repay debt. Overall net debt of \$42.2 million, including the project, as a percentage of total personal income is 2.9%.

$$\frac{\text{Overall net debt}}{\text{Personal income}} = \frac{\$ 42,096,196}{\$1,437,146,870} \times 100 = 2.9$$

A strong rating is below 4%.

Direct debt outstanding per capita indicates the burden on the city from the issued general obligation debt. The direct debt outstanding per capita was \$218 for Wichita Falls. Below \$250 per capita is a strong rating.

Wichita Falls's overall net debt outstanding per capita is about \$437 including the additional debt of the project.

$$\frac{\text{Overall net debt}}{\text{1990 population}} = \frac{\$42,096,196}{96,259} = \$437$$

A strong rating is below \$450 per capita. This shows the relative debt burden on the community and its overlapping jurisdiction.

Another indicator, the percent of the direct net debt outstanding that is due within the next 5 years, would indicate the relative burden of the debt service requirements during the payback period and the ability of the community to afford the debt. The maturity on outstanding GO bonds is 1991 and thereafter with about \$11,434,474 due within the next 5 years. Including the costs of the proposed project of \$600,000, the total direct net debt due in the next 5 years is \$12,034,474. The percent of direct net debt outstanding that is due within the next 5 years is about 57.5. A strong financial rating is above 30%.



$$\frac{\text{Direct Net debt due within 5 years}}{\text{Overall net debt}} = \frac{\$12,034,474}{\$20,985,000} \times 100 = 57.5$$

**CONCLUSION**

The city of Wichita Falls appears to be in a good position to incur the additional debt that would be required to finance their portion of the Plum Creek flood control project. Table 7-9 summarizes the city's financial indicator ratings.

TABLE 7-9  
FINANCIAL INDICATOR RATINGS

Indicator	Indicator Value	Indicator Rating
Annual rate of change in population	.22%	Average
Current surplus as a percentage of total current expenditures	1.4%	Average
Real property tax collection rate	97.44%	Average
Property tax revenues as a percentage of full market value of real property	1.3%	Strong
Overall net debt as a percentage of full market value of real property	2.4%	Strong
Overall net debt outstanding as a percentage of personal income	2.9%	Strong
Direct net debt per capita	\$218.00	Strong
Overall net debt per capita	\$437.00	Strong
Percent direct net debt outstanding due within the next 5 years	57.5%	Strong

All the city's indicators reflect a strong or average rating based on national averages relating to a community's financial condition. Wichita Falls has a good debt record with healthy bond ratings. Furthermore, the city is not overextended and appears to have room to expand their debt load for new capital projects. Wichita Falls is currently cost sharing with the Corps of Engineers in the Holliday Creek flood control project. The city is familiar with the responsibilities of cost sharing in Federal flood control projects and has maintained a history of healthy debt management.

**APPENDIX 8 - SECTION 404 DETERMINATION**

| | | | | | | | | | | | | | | | | | | | | |

## APPENDIX 8

### NATIONWIDE PERMIT FOR DISCHARGES IN CERTAIN WATERS

Discharges of dredged or fill material into the waters listed in paragraphs (a)(26)(i) and (ii) of this section, except those which cause the loss or substantial adverse modification of 10 acres or more of such waters of the United States, including wetlands, are authorized under this Nationwide permit. For discharges which cause the loss or substantial adverse modification of 1 to 10 acres of such waters, including wetlands, notification to the District Engineer is required in accordance with Section 330.7. This Nationwide permit is authorized pursuant to Section 404 of the Clean Water Act. This Nationwide permit (33 CFR 330.5) became effective January 12, 1987, following publication in the Federal Register.

(i) Non-tidal rivers, streams and their lakes and impoundments, including adjacent wetlands, that are located above the headwaters.

(ii) Other non-tidal waters of the United States, including adjacent wetlands, that are not part of a surface tributary system to interstate waters or navigable waters of the United States.

For an activity to be authorized under this Nationwide permit, it must satisfy the following special conditions:

a. That any discharge of dredged or fill material will not occur in the proximity of a public water supply intake.

b. That any discharge of dredged or fill material will not occur in areas of concentrated shellfish production.

c. That the activity will not jeopardize a threatened or endangered species, as identified under the Endangered Species Act.

d. That the activity shall not significantly disrupt the movement of those species of aquatic life indigenous to the water body.

e. That any discharge of dredged or fill material shall consist of suitable material free from toxic pollutants in toxic amounts.

f. That any structure or fill authorized shall be properly maintained.

g. That the activity will not occur in a component of the National Wild and Scenic River System.

h. That the activity shall not cause an unacceptable interference with navigation.

i. That if the activity may adversely affect historic properties which the National Park Service has listed on or determined eligible for listing on the National Register of Historic Places, the permittee will notify the District Engineer. If the District Engineer determines that such historic properties may be adversely affected, he will provide the Advisory Council on Historic Preservation an opportunity to comment on the effects on such historic properties or he will consider modification, suspension, or revocation in accordance with 33 CFR 325.7. Furthermore, that if the permittee before or during prosecution of the work authorized, encounters a historic property that has not been listed or determined eligible for listing on the National Register, but which may be eligible for listing on the National Register, he shall immediately notify the District Engineer.

j. That the construction or operation of the activity will not impair reserved tribal rights, including, but not limited to, reserved water rights and treaty fishing and hunting rights.

k. That the best management practices listed below shall be followed to the maximum extent practicable:

(1) Discharges of dredged or fill material into waters of the United States shall be avoided or minimized through the use of other practical alternatives.

(2) Discharges in spawning areas during spawning seasons shall be avoided.

(3) Discharges shall not restrict or impede the movement of aquatic species indigenous to the waters or the passage of normal or expected high flows or cause the relocation of the waters (unless the primary purpose of the fill is to impound waters).

(4) If the discharge creates an impoundment water, adverse impacts on the aquatic system caused by the accelerated passage of water and/or the restriction of its flow shall be minimized.

(5) Discharges in wetland areas shall be avoided.

(6) Heavy equipment working in wetlands shall be placed on mats.

(7) Discharges into breeding areas for migratory waterfowl shall be avoided.

(8) All temporary fills shall be removed in their entirety.

For additional information concerning the Nationwide Permit, please contact the Chief, Regulatory Section, Tulsa District, U.S. Army Corps of Engineers, P.O. Box 61, Tulsa, OK 74121-0061, or telephone (918) 581-7261.



July 7, 1992

Colonel F. Lee Smith, District Engineer  
Tulsa District, Corps of Engineers  
P.O. Box 61  
Tulsa, OK 74121-0061

Dear Sir:

The City of Wichita Falls, Texas after consultation with representatives of the residents of the affected area of Plum Creek vicinity and in accordance with your request of a letter of intent, state: That the City of Wichita Falls shall have no obligation to incur any cost of liability with regards to this project until such time that a written agreement may be entered into. The City of Wichita Falls shall have no obligation to enter into a written agreement unless the City in its sole discretion decides that it has sufficient public funds available to fund its share of the project. Subject to the same conditions and prior to project construction, the City of Wichita Falls understands that it must enter into a Local Cooperation Agreement as local sponsor to:

a. Subject to the non-Federal cost limit of 25% of the total project cost, provide without cost to the United States, in compliance with the Uniform Relocation Assistance and Real Property Acquisition Policies Act of 1970 (Public Law 91-646), all lands, easements, and rights-of-way necessary for implementation, maintenance, and operation of the project;

b. Subject to the non-Federal cost limit of 25% of the total project cost, bear the cost of all alterations and relocations of buildings, utilities, storm drains, roads, and other community services required for implementation of the project;

c. Hold and save the United States free from damages due to implementation and subsequent operation and maintenance of the project, except damages due to the fault or negligence of the United States or its contractors;

d. Maintain and operate the project, including mitigation features, after completion in accordance with regulations prescribed by the Secretary of the Army;

e. Provide a cash contribution of 5% of the total project cost;

Colonel F. Lee Smith  
July 7, 1992  
Page 2

- f. Provide cash in excess of the Federal limitation;
- g. Prevent encroachment that could interfere with the maintenance and operation of the flood control project;
- h. At least annually, publicize and notify all interested parties that the project will not provide protection from the occurrence of storms greater than the project design flood; and
- i. Adopt and enforce floodplain regulations and assure compatibility of future development that would ensure an unobstructed floodway.

Sincerely,

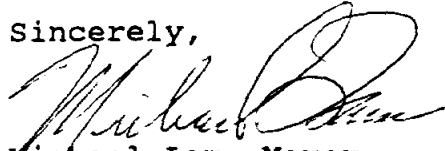

Michael Lam, Mayor  
City of Wichita Falls

ML/gd



July 8, 1992

Colonel F. Lee Smith, District Engineer  
Tulsa District, Corps of Engineers  
P.O. Box 61  
Tulsa, OK 74121-0061

RE: Plum Creek Feasibility Study (Financial Plan)

Dear Col. Smith:

The City of Wichita Falls, Texas, after a written agreement is entered into with the Corps of Engineers, can finance the City share for construction of the project from available funds.

Sincerely,

A handwritten signature in cursive script that reads "George R. Bonnett".

George R. Bonnett, P.E.  
Director of Public Works

GRB/gd





# Wichita Falls

April 28, 1988

Colonel Frank Patete  
District Commander  
Corps of Engineers  
P.O. Box 61  
Tulsa, OK 74121-0061

RE: Plum Creek Reconnaissance Study

Dear Colonel Patete:

The purpose of this letter is to request a reconnaissance study on the Plum Creek watershed as detailed in Mr. Robert D. Brown's letter of April 22, 1988. It is our understanding that this reconnaissance study will be totally funded by the Corps of Engineers and will take approximately eight months to complete.

As always, our staff will be eager to work with the Corps of Engineers personnel as they work on this study. Should you have any questions concerning this request, please don't hesitate to contact Mr. George Bonnett, Director of Public Works.

Sincerely,

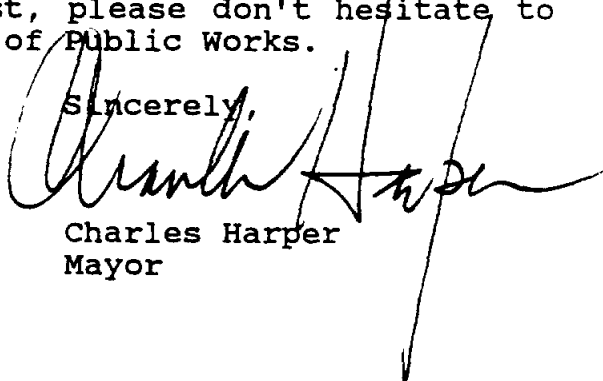

Charles Harper  
Mayor

GRB/pm

April 22, 1988

Planning  
General Planning Branch

Mr. George Bonnett  
Director of Public Works  
City of Wichita Falls  
Post Office Box 1431  
Wichita Falls, TX 76307

Dear Mr. Bonnett:

This is to provide you with a summary of the results of the recently completed study of the flooding along Plum Creek in the city of Wichita Falls and with a sample letter-of-intent as contained in the enclosed brochure. The study was completed under authority of Section 205 of the 1948 Flood Control Act, as amended.

In the study, a detention plan along Plum Creek was evaluated as the best plan. That plan has a benefit-to-cost ratio of 2.0 to 1. A pertinent data sheet summarizing the plan is enclosed.

The study recommended that a more detailed study, referred to as a reconnaissance study, be completed prior to recommending a plan of action. The reconnaissance study will be totally funded by the Corps, and it is anticipated that it will take about 8 months to complete. As Mr. Walter Kneib indicated to you on April 15, 1988, before the Corps can proceed to the reconnaissance study, the city needs to provide the Corps with a letter that states the city's desire to sponsor a flood protection project along Plum Creek.

If you need additional information, you may contact Mr. Ed Endacott at (918) 581-7827.

Sincerely,

Robert D. Brown  
Chief, Planning Division

Enclosures

CF:  
Gen Plng Br  
Sm Proj Sec

  
**Wichita Falls**  
**T E X A S**

Office of Mayor  
761-7400

May 7, 1987

Colonel Frank M. Patete, District Engineer  
Tulsa District, Corps of Engineers  
P.O. Box 61  
Tulsa, Oklahoma 74121-0061

Dear Sir:

The City of Wichita Falls has experienced extensive damages in the past from overflows of the Plum Creek. The latest flood was in June of 1985.

I understand that the Corps of Engineers can study the flood problem on Plum Creek under Section 205 of the 1948 Flood Control Act, as amended. The City of Wichita Falls is willing to sponsor a flood protection project. I request that a study be made to determine the engineering and economic feasibility of constructing a flood protection project for Plum Creek.

I hope your office can be of assistance in alleviating the flood problem in our city.

Sincerely,

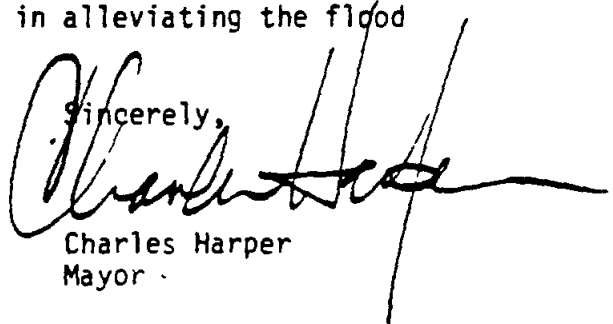

Charles Harper  
Mayor

cc: Ed Endicott  
Tulsa District, Corps of Engineers

# FARMLAND CONVERSION IMPACT RATING

<b>PART I (To be completed by Federal Agency)</b>		Date Of Land Evaluation Request 07/11/91			
Name Of Project Plum Creek Flood Control Project		Federal Agency Involved U.S. Army Corps of Engineers			
Proposed Land Use Flood Detention Site		County And State Wichita County, TX			
<b>PART II (To be completed by SCS)</b>		Date Request Received By SCS 9-19-91			
Does the site contain prime, unique, statewide or local important farmland? (If no, the FPPA does not apply - do not complete additional parts of this form).		Yes <input type="checkbox"/>	No <input checked="" type="checkbox"/>	Acres Irrigated	Average Farm Size
Major Crops	Farmable Land In Govt. Jurisdiction Acres: %	Amounts Of Farmland As Defined In FPPA Acres: %			
Name Of Land Evaluation System Used	Name Of Local Site Assessment System	Date Land Evaluation Returned By SCS			
<b>PART III (To be completed by Federal Agency)</b>		Alternative Site Rating			
		Site A	Site B	Site C	Site D
A. Total Acres To Be Converted Directly		93			
B. Total Acres To Be Converted Indirectly		112			
C. Total Acres In Site		205			
<b>PART IV (To be completed by SCS) Land Evaluation Information</b>					
A. Total Acres Prime And Unique Farmland					
B. Total Acres Statewide And Local Important Farmland					
C. Percentage Of Farmland In County Or Local Govt. Unit To Be Converted					
D. Percentage Of Farmland In Govt. Jurisdiction With Same Or Higher Relative Value					
<b>PART V (To be completed by SCS) Land Evaluation Criterion</b> Relative Value Of Farmland To Be Converted (Scale of 0 to 100 Points)					
<b>PART VI (To be completed by Federal Agency)</b> Site Assessment Criteria (These criteria are explained in 7 CFR 658.5(b))		Maximum Points			
1. Area In Nonurban Use		0			
2. Perimeter In Nonurban Use		0			
3. Percent Of Site Being Farmed		0			
4. Protection Provided By State And Local Government		0			
5. Distance From Urban Builtup Area		5			
6. Distance To Urban Support Services		0			
7. Size Of Present Farm Unit Compared To Average		1			
8. Creation Of Nonfarmable Farmland		0			
9. Availability Of Farm Support Services		5			
10. On-Farm Investments		0			
11. Effects Of Conversion On Farm Support Services		0			
12. Compatibility With Existing Agricultural Use		0			
<b>TOTAL SITE ASSESSMENT POINTS</b>		<b>160</b>	<b>11</b>		
<b>PART VII (To be completed by Federal Agency)</b>					
Relative Value Of Farmland (From Part V)		100			
Total Site Assessment (From Part VI above or a local site assessment)		160	11		
<b>TOTAL POINTS (Total of above 2 lines)</b>		<b>260</b>			
Site Selected:		Date Of Selection		Was A Local Site Assessment Used? Yes <input type="checkbox"/> No <input type="checkbox"/>	
Reason For Selection:					



May 5, 1992

Ms. Margaret Johanning  
Tulsa District Corps of Engineers  
Planning Division SWT/PLGD  
P.O. Box 62  
Tulsa, OK 74121-0062

RE: Plum Creek Feasibility Study

Dear Ms. Johanning:

I have reviewed aerial photographs of the site provided by the Soil Conservation Survey. The site has been primarily agricultural for the last thirty years. There is no evidence that hazardous materials have ever been stored at the site.

If you have any questions concerning this matter, please feel free to contact this department.

Sincerely,

A handwritten signature in cursive script that reads "John S. Taylor P.E.".

John S. Taylor, P.E.  
Project Administrator

JST/gd

# APPENDIX 10 - LETTER OF INTENT

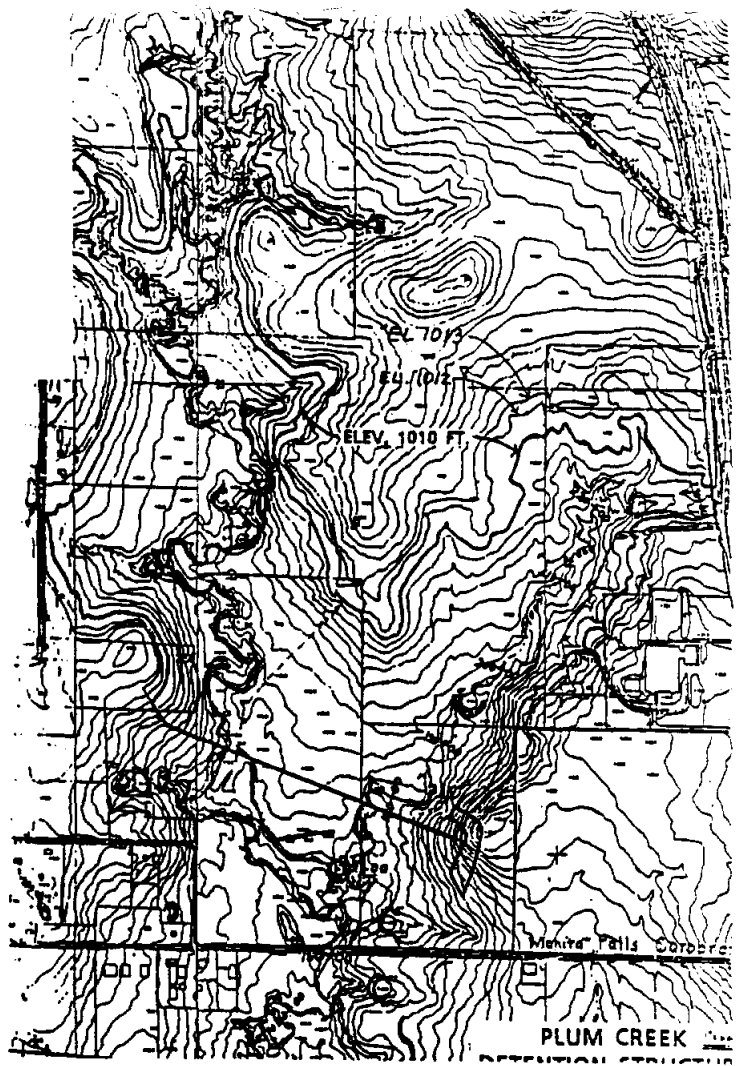

SCALE - 1" = 1667'

SOILS IN AREA (From Wichita County published Soil Survey)

SOILS	PRIME
AW - ASA AND POIT SOILS FREQUENTLY FLOODED	No
BcB - BLUEGROVE loam	No <sup>L</sup>
KaB - KAMAY silt loam	No
DaB - DEANDALE silt loam	No
ObC - Oben FINE SANDY loam	No

L' PRIME IF IRRIGATED AND THERE IS NO IRRIGATION IN THIS AREA AND NO AVAILABLE IRRIGATION WATER.



PLUM CREEK PUBLIC MEETING  
January 16, 1992

NAME	AGENCY
Margaret Johanning	Corps of Engineers
Debbie Tucker	Corps of Engineers
Gene Lilly	Corps of Engineers
Mary Beth Hudson	Corps of Engineers
Dorcas Chasteen	City of Wichita Falls/Property Admin
Bill Parker	City of Wichita Falls/City Engineer
Don Kirkham	City of Wichita Falls/Councilor
Bob Puckett	Texan
Willie Wall	Wichita County
Julie Palm	Times/Record News
Randy W. Skinner	Citizen
Christine Sadler	Citizen
Sammie Marten	Corps of Engineers
Roger McKinney	City of Wichita Falls/Planning Dir.
Troy Jensen	City of Wichita Falls
Gloria Dicken	City of Wichita Falls/Public Works
George Bonnett	City of Wichita Falls/Director of PW
Scott Taylor	City of Wichita Falls/Engineering

PUBLIC MEETING PRESENTATION  
ON PLUM CREEK  
January 16, 1992

My name is Scott Taylor. I am an engineer for the city of Wichita Falls Public Works Department, and I am also a member of the Study Management Team for the Plum Creek Detailed Project Study. It's a long word to say, but I am a city representative for the Corps of Engineers Feasibility Study of Plum Creek.

Before we get started, I would like to introduce the city officials who are here. Councilor Don Kirkham is here from the City Council. Is there anybody here from the County? County officials? Would you care to introduce yourself?

I am Willie Wall representing County Commissioner Gordon Griffith who is unable to attend today.

From the city staff, the Director of Public Works, Mr. George Bonnett; Mr. Roger McKinney, Director of Planning; and Mr. Bill Parker, City Engineer. From the Tulsa District, Corps of Engineers, we are very pleased to have Ms. Margaret Johanning, Mr. Gene Lilly, and Ms. Debbie Tucker. They will be making the presentation and answering questions.

Before I introduce Gene to get started with the presentation, this project is funded under the Water Resources Development Act of 1986. This Act calls for studies that can be performed with equal cost sharing from the Federal Government and the local entity. The cost of this study is \$400,000. The city's share, of course, is \$200,000. The city was very pleased to get a \$100,000 grant from the Texas Water Development Board to aid funding of our portion of the study. It was very worthwhile for the Water Development Board to issue us a grant, and we appreciate it.

Margaret and Gene wanted me to tell a joke, but I don't know any jokes. So, we'll get started with Plum Creek.

There are several Plum Creeks that everybody discusses. The Plum Creek we are talking about is what is commonly called the main branch of Plum Creek. It runs north and south on a north-south line and is generally west of I-44 and bounded by City View on the west. The area we are discussing for our project is north of Airport Drive and bounded by the freeway on the east side. At this time, I would like to introduce Mr. Gene Lilly with the Planning Division of the Tulsa District, Corps of Engineers. He's going to make some brief introductions, and then he will turn the program over to Margaret.

Thank you, Scott. Good afternoon. I am the Program Coordinator for the Tulsa District, Corps of Engineers Continuing Authorities Program. I would like to thank you for allowing us to

participate in this meeting with you. Let me introduce Margaret Johanning, the Study Manager, and Ms. Debbie Tucker, from the Real Estate Division. We're here to provide information and answer questions regarding the Plum Creek study.

The purpose of this study is to determine the best plan to provide flood protection along Plum Creek. I will be discussing the overall Continuing Authorities Program, and Ms. Johanning will be discussing the more detailed aspects of the Feasibility Study.

The study was requested by the city of Wichita Falls and is being conducted under the authority of Section 205 of the 1948 Flood Control Act, as amended. Under that authority, the Corps may study, adopt, and construct small flood control projects. The Federal share of cost for any one project may not exceed \$5 million, and a non-Federal interest, which in this case is the city of Wichita Falls, must participate in project costs in accordance with established requirements, which I will discuss later.

First, I would like to go into the project milestones that we have completed and some of the project milestones that we would need to complete in order to successfully implement the project.

Our first milestone, which was completed, was the appraisal study. It was started in January 1988 and completed in April 1988. The purpose of that study was to identify a project with the potential to meet Federal criteria for further participation.

Following the appraisal study, we initiated a reconnaissance study in July 1988 and completed that study in February 1989. That study determined that an upstream detention site would alleviate some of the downstream flooding and might show the economic benefits needed to fund a more detailed study. The project cost was estimated at \$2.6 million. That was a reconnaissance-level effort.

Following the reconnaissance study, the city of Wichita Falls and the Corps of Engineers agreed to initiate and proceed with a more detailed cost-shared study in the feasibility phase. Scott referred to it as a detailed project study. We also refer to it as a feasibility study and that's what I will be calling it during the rest of this presentation.

In the Feasibility Cost-Sharing Agreement, as Scott mentioned, the city of Wichita Falls provided half the study cost. That Feasibility Cost-Sharing Agreement was signed in May 1990.

In October 1990, we received Federal funds to initiate the study. The purpose of the study was to identify problems and opportunities, to define planning constraints based on Federal requirements and input from the city of Wichita Falls, to perform alternative planning analysis, and finally, to select the best plan for providing flood protection along Plum Creek.

Following completion of the detailed project study, which is nearing completion now, if it is determined that the project meets Federal criteria and the city of Wichita Falls wants to continue with future efforts, we will initiate plans and specifications.

Plans and specifications consist of detailed engineering drawings and general specifications which will allow the project to be constructed. We anticipate developing plans and specifications to take approximately 12 months.

Following completion of plans and specifications, we would request construction approval from our headquarters in Washington. That approval process would take approximately 3 months and is contingent upon the availability of Federal funds.

Following construction approval, we would execute a Local Cooperation Agreement, which would be an agreement between the city of Wichita Falls and the Corps of Engineers. In that agreement, the city would agree to provide a cash contribution of 5 to 25 percent of the construction costs and would agree to acquire the lands, easements, and rights-of-way; provide the utility relocations; and agree to operate and maintain the project according to Federal criteria.

Following execution of the Local Cooperation Agreement, we would initiate the real estate acquisitions and would allow a minimum of 12 months for this activity.

Following completion of real estate acquisitions, we would advertise the construction contract and initiate construction. Construction would probably take from 1 to 2 years. After construction, the local sponsor would take over maintenance of the project.

I would now like to briefly discuss with you the division of responsibility with respect to the 205 program. The responsibilities are divided between the Federal Government and the city of Wichita Falls. The Federal Government's responsibilities are appraisal and reconnaissance study costs, 50 percent of the detailed study costs, and 50 to 75 percent of the construction costs. The Federal Government also prepares the plans and specifications and provides construction administration.

The local sponsor's responsibilities will include 50 percent of the feasibility study costs. A portion of that can include providing in-kind services, such as engineering and study management. In the event that there is a project that will proceed through construction, the local sponsor will also provide lands, easements, rights-of-way, and relocations. The city will also be responsible for cash contributions of 5 to 25 percent of the total project costs and 100 percent of any costs exceeding the Federal limitations, which, in this case, I don't think will happen. The city will be responsible for maintenance and operation of the

project, adherence to or adoption of floodplain regulations, and annual publication of the level of protection of the project.

The first condition Scott mentioned in the feasibility study was cost sharing. Also shared is management responsibility. Study management of this study has been provided at two levels. We have two entities that provide study management guidance. One is the Executive Committee, which provides overall study management, and consists of the Tulsa District District Engineer, Colonel Smith; the Tulsa District, Chief of Planning Division, Mr. David Steele; the City of Wichita Falls Director of Public Works, Mr. George Bonnett; and the City Engineer, Mr. Bill Parker. The other entity is the Study Management Team, which provides the day to day management of the study. The team also informs the Executive Committee of the progress of the study. The members of the Study Management Team are appointed by the Executive Committee. The Study Management Team currently consists of Scott Taylor, from the city of Wichita Falls; Ms. Margaret Johanning, of the Corps of Engineers; and myself.

Again, I would like to thank you for allowing us to provide you this information. I would now like to ask Ms. Margaret Johanning to give you information regarding the detailed studies during the feasibility phase.

We tried to provide you with a handout if you are having trouble following where Plum Creek and the flood area is located, so you might look at the very back page with the USGS quad map so you can see where it is. The maps that we have up here have the detailed drawings of what the detention site would look like when the project is completed. The feasibility study is a continuation of the earlier reconnaissance study and it is a continuation of the alternatives looked at.

Early on, the detention site was still the main alternative that we were looking at in detail. A channel improvement alternative also was considered. Before we go into the specifics of those two plans, I just want to mention that in the study there are certain planning constraints that we have to use. One, we are constrained by the total Federal limitation of \$5 million. Two, the selected plan needs to be complete in itself and fully effective for the flooding problem under study. Another constraint is the fact that any project that might be recommended has to be economically justified under Federal criteria, and then the selected plan must be acceptable to our local sponsor. Now when we look at alternatives that are available to us, you might keep those constraints in mind.

On the other map in the handout, we show you where we looked at the channel improvement alternative. If you'll notice on the map, the section of channel that we looked at was south of the North Side Irrigation Canal down to Old Iowa Park Highway, which is a reach of channel that is already concrete lined. We looked at

going back with a trapezoidal channel with side slopes of 3 to 1, and we would extend the bottom of the channel 10 feet. This would also increase the top width of the existing channel. The channel reach that we looked at is constrained by the locations of the residences that encroach the channel on both sides. So, in addition to the construction costs, which are approximately \$1.9 million, there would also be an increase in the cost of real estate, the relocation of utilities, and bridge replacements. When we looked at the cost of that plan in relation to the benefits that were determined by the economic analysis conducted by our economists, that plan did not have an adequate benefit-to-cost ratio; therefore, we will not continue to look at that plan.

The detention site analysis was one area of the study which, in addition to the planning constraints, also had hydrology and hydraulic constraints to consider. One constraint was that we did not want the pool elevation to flood the freeway on the east side of the detention site, nor did we want the maximum pool to flood any residences on the west side of the detention site. There also has to be storage in the pool area for sediments that will be carried downstream, over a 100-year period, and the outlet works have to be designed so as not to exceed the channel capacity during low flows. We had to take that design element into consideration in sizing the structure. In addition, we have selected the detention size that maximizes economic benefits and, therefore, is the plan recommended under Federal criteria.

We are looking at the National Economic Development (NED) plan that has the most net benefits. To identify the NED plan, we had to look at alternative reservoir sizes at the same location as the recommended site, but we looked at different maximum pool elevations and analyzed different types of spillway configurations. By calculating the associated costs and benefits, we could develop a curve of net benefits versus frequency of event that might occur. This curve showed which plan would be the most cost effective. That analysis showed us that the highest benefit occurred at the 50-year frequency of protection with a top of dam elevation of 1014, including 3 feet of freeboard and a maximum pool elevation of 1011. That plan was used to develop detailed design and costs.

The detention alternative is flow-through, dry detention where there is not a pool consistently during normal weather. The outlet works are designed to drain the pool in 7 to 10 days. The top of dam is at elevation 1014 with 3 feet of freeboard, and is about 3,100 feet long with a top width of 15 feet. There is a road across the top for maintenance purposes only. The embankment has 1 on 3 side slopes and an emergency spillway with a crest elevation of 1002. The embankment is grass lined on both sides. During the design, it was determined that a diversion ditch would be needed to provide drainage from one arm of the stream branch to the outlet pipe since the area is so flat. This would connect both arms of the stream to the structure. The outlet pipe is a 30-inch reinforced concrete pipe for releasing low flows to the stream.

In addition to completing the planning design, we need to go ahead and quantify the cost for the excavation materials and construction features associated with the project. The detailed project report will include an environmental assessment. The project features have been coordinated with Federal and State agencies regarding impacts on the environment. Sometimes we need a mitigation area to offset some losses of habitat that occur along the project site. That's another feature that we have to finish. The detention site has been primarily agricultural, and the cultural resources assessment that was performed indicated no cultural features at the site which would be a problem.

The land requirements that we need for structures such as this include flowage easements, the lands that might have water on them during operation of the structure. These would be the acreages under worst conditions when the detention facility would be holding water and the land would have water standing on it. We use flowage easements on the land where the water would be. Borrow easements would also be required for excavation of embankment materials. Additionally, we would require the fee purchase of the embankment, spillway, and mitigation area if that requirement is determined necessary. There is a road easement to provide access to the dam.

There are some utility relocations at the site; these are the electrical lines that cross the site. Some poles will need to be raised; a 400-foot segment will need to be relocated underground. We don't have the full cost of the plan yet because the final design has just been completed. The benefit-to-cost evaluation for the project was done some months ago. The average annual benefits that are associated with the project are on the order of \$500,000. We still have residual damages of \$73,000 because no plan is 100% effective. The floodplain value of the properties and their contents associated with the structure are around \$26 million. The benefit-to-cost ratio is estimated to exceed unity; therefore, the project will meet Federal criteria for economic justification. This is all the information at this time on the project. I will now turn the meeting back to Scott Taylor for questions. Thank you.

O.K., what we'd like to do - we'll be free to answer any questions that you have. It may sound a little redundant, but since the Texas Water Development Board wanted a transcript of the meeting, what I'm going to do for the persons in my office is make sure we get the questions asked, answered, and written down. When you ask your question, I will repeat the question, and then the proper person will answer. I will open the floor up to any questions. Yes sir.

Q: The pool now - is there any constant level north of the dam?

(Scott) The question is, "Is there any constant pool elevation that will be in the drainage facility?"

A: There are pool elevations associated with the project although the low flow pipe drain is at the current elevation of Plum Creek. The spillway is at elevation 1002 which will create a pool area of water before it will drain. The low flow pipe will control the flow the majority of the time.

Q: Then am I to understand that actually, Plum Creek will continue to flow?

A: Yes. Detention is provided only for significant rainfall.

Q: The reason I asked is that we have a couple of tanks out there with dams. What will happen to them?

(Scott) The question is, "Will there be an impact on the facilities that are upstream of the dam, particularly to the tanks that have dams on them as they exist right now?"

A: I don't know how well you can see the smaller maps that show the pool area. Q: Do you know if they are included in this pool area?

A: Yes.

Q: Are you approximately up here?

A: He said, "both of them." No, they're both over there.

Q: (Scott asking question) Is that one of them right there?

A: Probably. I can't see from here.

Q: Is this it?

A: No, it's further. I've got another one on further to the north. But both of them catch enough water, you know. At some times, they're almost dry. Q: What effect, what are you going to do with those?

A: Well, I might ask the real estate person to help with that because the area is in the pool where damages that might occur will be compensated for.

(Debbie) During the appraisal process, we will acquire the land for a flowage easement. If you have a structure on your land that we expect will have water over it occasionally, you would be compensated.

Q: You would not take them out?

A: I don't know the answer to that.



Scott: Looking at the map, I don't think that will happen, and in low flows, your tanks will fill up first before that water goes down to the dam. In flood events, they would be inundated, but as the water drains behind the dam, the tanks would remain the same. If the dams on your tanks don't fail from the inundation, the water should remain in them.

Q: How large is the detention area?

A: The maximum acres of land that might have water on them would be about 300 acres, and that would be under the most severe of meteorological events. For smaller events, there would be fewer acres flooded.

Q: What is the plan for replacing boundary fences if they're under water long enough to receive damage?

A: (Scott) Since that is going to be our facility, I will let Mr. Bonnett answer that question.

I am George Bonnett, Director of Public Works. I think that is part of what the detailed plan and specifications would address. My guess is that the boundary fences will not, in fact, be affected significantly. Again, I am going without detailed plans and specs, so this is my opinion at this point. The fence is only effective when it is dry. That is, it is only needed when it is dry. Assuming it's under water, only the fish care and the fish can go right through. Should not have any effect.

Again, Debbie has addressed the fact that when we purchase the land, the impact of the water that we will have stored will be considered in arriving at a cost for the flowage easement.

Q: When the fence is under water, that will speed up the deterioration of the fence. Is the city going to be responsible for replacing the fences?

Scott: I keep looking at Mr. Bonnett for the answer. Margaret, do you want to take a shot at that?

A: (Margaret) I don't know if that is a maintenance question or a construction one.

George: That's an interesting question, and my gut feeling is that we will probably address that at the time of appraisal. We would probably address that as an impact to the property when the purchase the flowage easement. That would be my guess. Again, this is very preliminary. It's a good question. It's just one that I don't think I can give you an absolute straight answer to at this point in time. Certainly, we will be prepared to address that at the time of appraisal, if we in fact move forward with this project. Does that help?

A: Yes.

Thank you.

Q: Will the diversion ditch connect both branches of Plum Creek?

A: The drawing shows that the east branch will be connected to the west branch and then goes south to the outlet works.

Q: That outlet will be open at all times?

A: Yes. It is an uncontrolled release structure.

Q: At normal times, there will be no pooling?

A: That is correct.

Q: I'll ask this question. The one that we see on the right over there - does that go into the school's lake? The school on Loop 11, Kirby Junior High.

Scott: I didn't think that the main branch goes that far east. There's only one drainage facility on Airport Drive, the one box culvert. The one that's on Northwest Freeway.

Q: The one by K-Mart does not get any of this water?

A: No, it does not.

Scott: Any other questions?

Before we leave today, I have a sign-up sheet that I would like to pass around. There's a section that says "Agency". If you are not with the city or the county, just sign in "Citizen" so that I can so designate in my report for the Water Development Board. I would like to thank you for your attendance today. I would particularly like to thank the people from the Corps of Engineers for coming down to spend time with us explaining this project. Thank you very much.