



**City of Buda Expansion of the Hays County, Texas,
Flood Early Warning System Network
within the Austin-Travis Lakes Planning Area**

TWDB Contract No. 1600012037

**Project Final Report
January 30, 2019**

APPENDIX A
City of Buda Resolution No. 2016-R-11

APPENDIX B.4
RM 967 at Bluff Street FEWS Construction Plans

APPENDIX C
FEWS Equipment Manuals

HydroLynx Systems, Inc.

Model 5090
Packaged Pressure Transducer Liquid Level Station
Instruction Manual

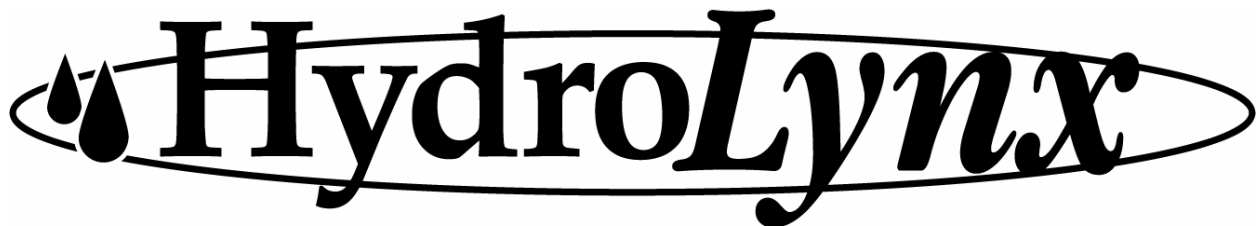

Document No: A102778
Document Revision Date: August, 2006

Receiving and Unpacking

Carefully unpack all components and compare to the packing list. Notify HydroLynx Systems immediately concerning any discrepancy. Inspect equipment to detect any damage that may have occurred during shipment. In the event of damage, any claim for loss must be filed immediately with the carrier by the consignee. If the equipment was shipped via Parcel Post or UPS, contact HydroLynx Systems for instructions.

Returns

If equipment is to be returned to the factory for any reason, call HydroLynx between 8:00 a.m. and 4:00 p.m. Pacific Time to request a Return Authorization Number (RA#). Include with the returned equipment a description of the problem and the name, address, and daytime phone number of the sender. Carefully pack the equipment to prevent damage during the return shipment. Call HydroLynx for packing instructions in the case of delicate or sensitive items. If packing facilities are not available, take the equipment to the nearest Post Office, UPS, or other freight service and obtain assistance with packaging. Please write the RA# on the outside of the box.

Warranty

HydroLynx Systems warrants that its products are free from defects in material and workmanship under normal use and service for a period of one year from the date of shipment from the factory. HydroLynx Systems' obligations under this warranty are limited to, at HydroLynx's option: (i) replacing; or (ii) repairing; any product determined to be defective. In no case shall HydroLynx Systems' liability exceed product's original purchase price. This warranty does not apply to any equipment that has been repaired or altered, except by HydroLynx Systems, or that has been subjected to misuse, negligence, or accident. It is expressly agreed that this warranty will be in lieu of all warranties of fitness and in lieu of the warranty of merchantability.

Address

**HydroLynx Systems, Inc.
950 Riverside Pkwy., Suite 10
West Sacramento, CA 95605
Phone: (916) 374-1800
Fax: (916) 374-1877
E-mail: hydro@hydrolynx.com**

Copyright 8 2006 by HydroLynx Systems, Inc.

TABLE OF CONTENTS

SECTION NO.	PAGE NO.
Equipment Configuration and Parts Identification	4
1.0 INTRODUCTION	5
1.1 General Description	5
1.2 Equipment Included	5
1.3 Specifications	5
2.0 INSTALLATION	5
2.1 Site Selection	5
2.1.1 Data Collection	5
2.1.2 Radio Path	6
2.1.3 Other Considerations	6
2.2 Assembly	6
2.2.1 Standpipe	6
2.2.2 Pressure Transducer	6
2.2.3 Installation Notes	7
3.0 THEORY OF OPERATION	7
4.0 TEST AND MAINTENANCE	7
4.1 Testing	7
4.2 Datum Point	7
4.3 Maintenance	8
5.0 FORMS AND DRAWINGS	8

Equipment Configuration and Parts Identification

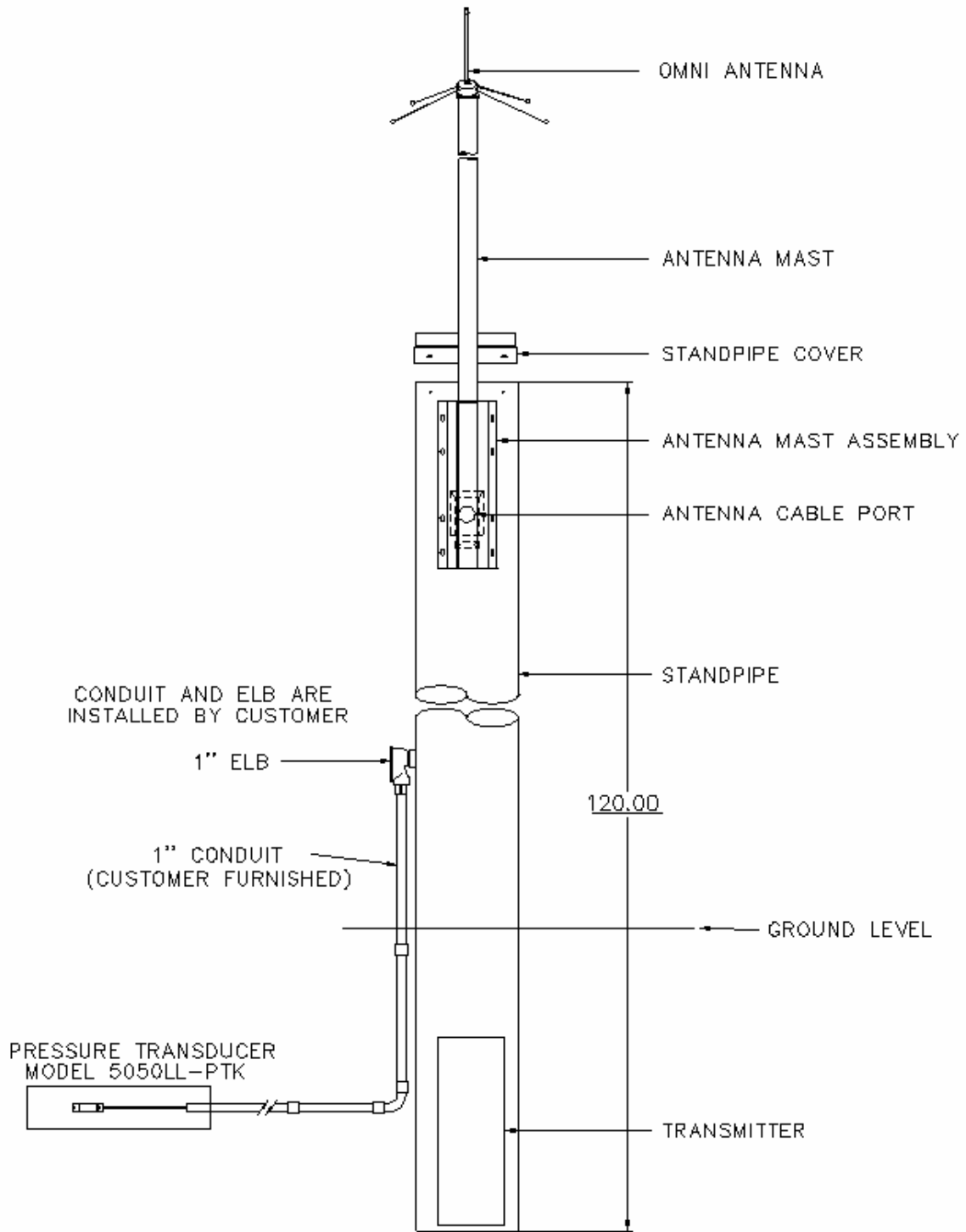

1.0 INTRODUCTION

1.1 General Description

The Model 5090 Packaged Pressure Transducer Liquid Level Station includes a Model 5096-90 Data Transmitter, a 5050LL-PTD Pressure Transducer and a weatherproof standpipe assembly. The standpipe assembly eliminates the need for a gauge house and an antenna tower. The Model 5054TS Rain Gauge Top Section may be added to the package to monitor rainfall.

1.2 Equipment Included

- 1> Standpipe
- 2> Standpipe cap (or optional 5054TS)
- 3> Antenna mast
- 4> Antenna
- 5> Antenna cable
- 6> Data transmitter
- 7> Pressure transducer
- 8> Lifting rope
- 9> Access door (optional)

1.3 Specifications

Height of mast:	13'2" above ground level
Material:	Aluminum

2.0 INSTALLATION

There are two basic types of pressure transducer installations in ALERT applications: the first type has the sensor attached to a structure (bridge, pier, etc.), while in the second type the sensor is installed down an embankment without structural support. Other installations include: ground water wells, stilling wells, weirs, or in pressure lines replacing mercury manometers.

2.1 Site Selection

2.1.1 Data Collection

Site location is based foremost on hydrological gauge characteristics. Ideally the sensor location will include a uniform flow established across the entire width of the stream and a channel that is not subject to change due to excessive scouring or silting. A permanent installation with these characteristics will insure a stable hydrological record.

2.1.2 Radio Path

Data collection constraints often require the site to be located at an elevation which is lower than the surrounding terrain. This is not desirable in terms of radio path, however, because the sensor is external to the standpipe, cable runs of up to 1000 feet are possible allowing for a wide range of possible standpipe locations. A radio path survey is recommended before installation.

2.1.3 Other Considerations

Easy access to the site for installation and especially maintenance will help insure a stable hydrological record. The sensor and conduit run must be protected from debris, boat anchors, fishing lines, and excessive current drag. There are no vandal-proof enclosures, however, some sites may be less prone to this type of damage than other high profile sites.

HydroLynx recommends a site visit during the dry season, to dimension and draw a plot plan. Use the plot plan to determine the measurement range and cable length of the pressure transducer and to plan for the construction materials that will be required during installation. See drawings AC102497, AC102504, and AC104747 for typical 5090 installations.

2.2 Assembly

The pressure transducer is shipped assembled. The PT cable must be disconnected from the desiccant box during installation. Refer to wiring diagram AC107407.

2.2.1 Standpipe

Refer to Basic Gauge manual for standpipe installation.

NOTE: Complete all civil works such as trenching, structural re-enforcement, or tree removal, before the standpipe is installed to avoid a situation requiring moving the standpipe.

2.2.2 Pressure Transducer

Each installation is unique which makes it difficult to provide step-by-step procedures covering every installation. Presented here are basic steps common to most installations. Refer to the typical installation diagrams.

- ! Install conduit from monitoring location to base of standpipe.
- ! Install standpipe.
- ! Drill 1 inch hole in standpipe to mount LB Box.
- ! Install conduit up standpipe to LB Box.
- ! Install LB Box.
- ! Route sensor cable through conduit and into standpipe.
- ! Connect sensor cable to desiccant box. Refer to drawing AC107407.

- ! Connect signal cable connector to the ANALOG port on the data transmitter.
- ! Test the gauge. Refer to the Basic Gauge Manual section 4.0.
- ! Place the data transmitter into the standpipe.
- ! Mount desiccant box to the bracket provided in standpipe.
- ! Attach cap (or optional 5054TS) to standpipe.

2.2.3 Installation Notes

The "gabion" or "anchor block" is used in installations where the pressure transducer is located away from the bank and usually involves a flat cable run. The sensor cannot be lowered into place so the cable is installed from the bottom up; typically, one inch conduit is used. This type of installation is not convenient for sensor replacement.

The PVC pipe is mounted to an existing structure or buried in the bank. The sensor slides down from an LB box until it rest on the placement screw; typically, 2" PVC pipe is used up to the LB box and half inch conduit from LB box to the standpipe. The LB box is mounted above the high water line for convenient sensor replacement.

For installations that involve long cable runs, the desiccant box may be installed outside the standpipe at a location above the high water line. This is meant to reduce the length, along with the cost, of the expensive vented pressure transducer cable.

3.0 THEORY OF OPERATION

The pressure transducer produces a 0-5 Vdc analog signal proportional to the liquid level above the sensor. The data transmitter converts the analog signal into ALERT data. This data is transmitted via RF link to the central site. Refer to Pressure Transducer and Data Transmitter manuals for operation.

4.0 TEST AND MAINTENANCE

4.1 Testing

Refer to Basic Gauge manual for standard tests.
Refer to Pressure Transducer manual for calibration.
Refer to Data Transmitter manual for sensor report setup.

4.2 Datum Point

The pressure transducer will measure the water level above the orifice, this is the Zero Datum Point (ZDP) for the sensor. The sensor ZDP must be referenced to an elevation for meaningful data reporting; this is done at the central site computer.

4.3 Maintenance

HydroLynx recommends annual maintenance for all gauges. In areas with heavy silting and other site specific considerations, maintenance may be required more often. Check the sensor installation for damage and debris when the level is at it's lowest.

The desiccant tube attached to the PT cable vent tube should be replaced when the desiccant color has changed from blue to pink. The desiccant bag should also be changed. Fresh desiccant is very important in preventing moisture from condensing in the sensor vent tube. Any moisture that collects in the pressure transducer vent tube will cause a failure.

5.0 FORMS AND DRAWINGS

AC102305	Assembly - 5090 Packaged Pressure Transducer Liquid Level Station
AC104747	5090 Bridge Installation
AC102497	5090 River Bank Installation with Gabion Anchor
AC102504	5090 River Bank Installation with Anchor Block
AC107807	5050LL-PTD Enclosure Installation

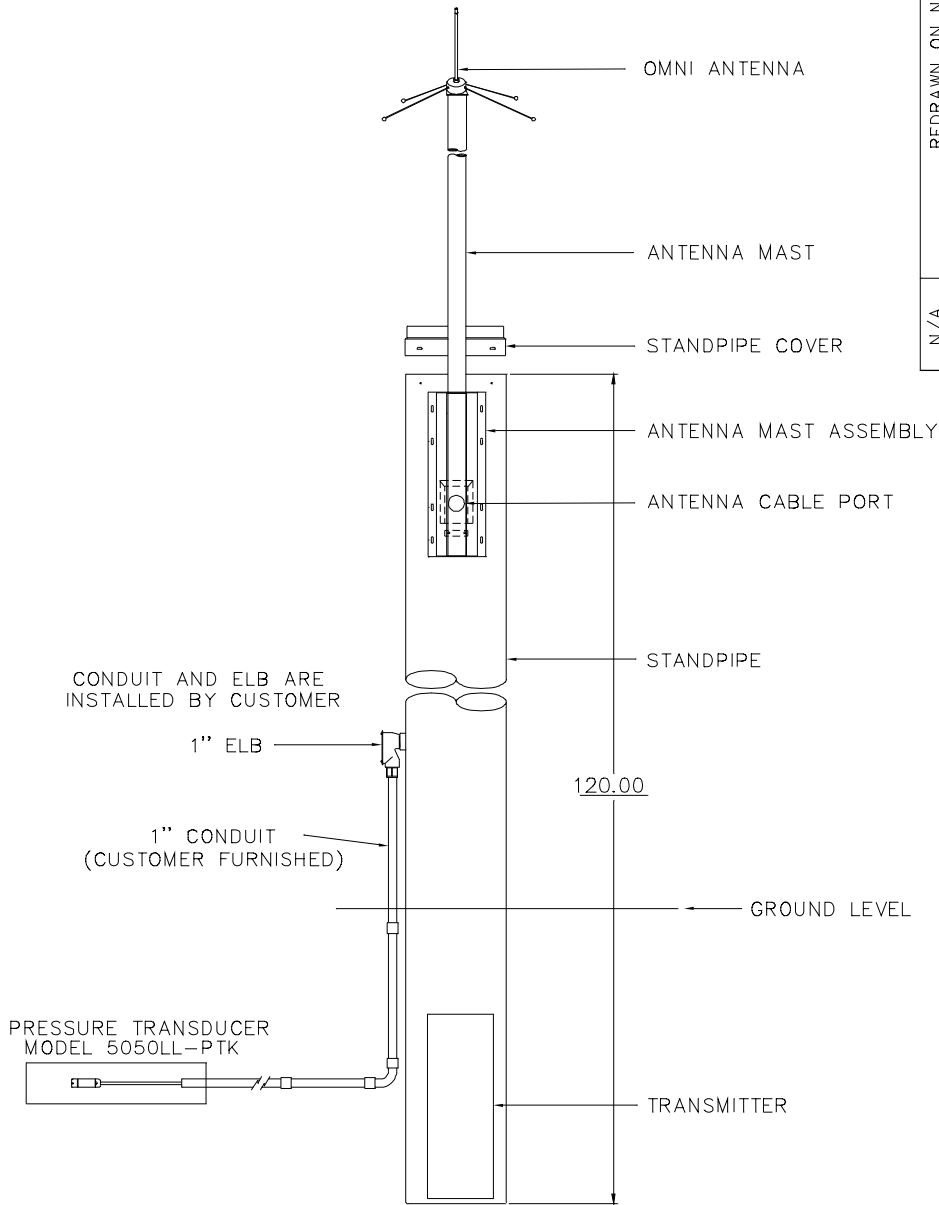

N/A	REDRAWN ON NEW BORDER	6/3/99
ECN#	DESCRIPTION	DATE
HydroLynx		
MODEL USAGE	MODEL NO.	5090
	TITLE	PACKAGED PRESSURE TRANSDUCER
		LIQUID LEVEL STATION
DRAWN BY	DATE	DATE
J. MICHAELS	6/3/99	
CHECKED BY	SIZE	REV
	B	A
	P/WG NO.	AC102305

- NOTES
1. RIGID CONDUIT MUST BE USED FOR ALL BURIAL APPLICATIONS.
 2. 1" CONDUIT SHOWN. OTHER DIAMETERS MAY BE USED.
 3. LENGTH OF CONDUIT IS DETERMINED BY SITE REQUIREMENTS. INSTALL ONLY ON DOWNSTREAM SIDE OF BRIDGE SUPPORT.
 4. CONDUIT AND STRAPS ARE FURNISHED AND INSTALLED BY CUSTOMER.
 5. POSITION OF ELB BOX MAY VARY.
 6. INSTALL STANDPIPE CONDUIT STRAPS USING SHEET METAL SCREWS. SEAL SCREW HOLES AND SCREW HEADS WITH RTV.

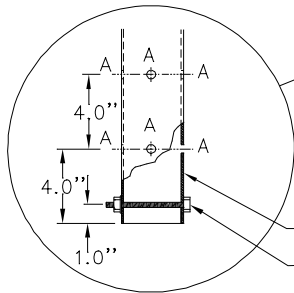
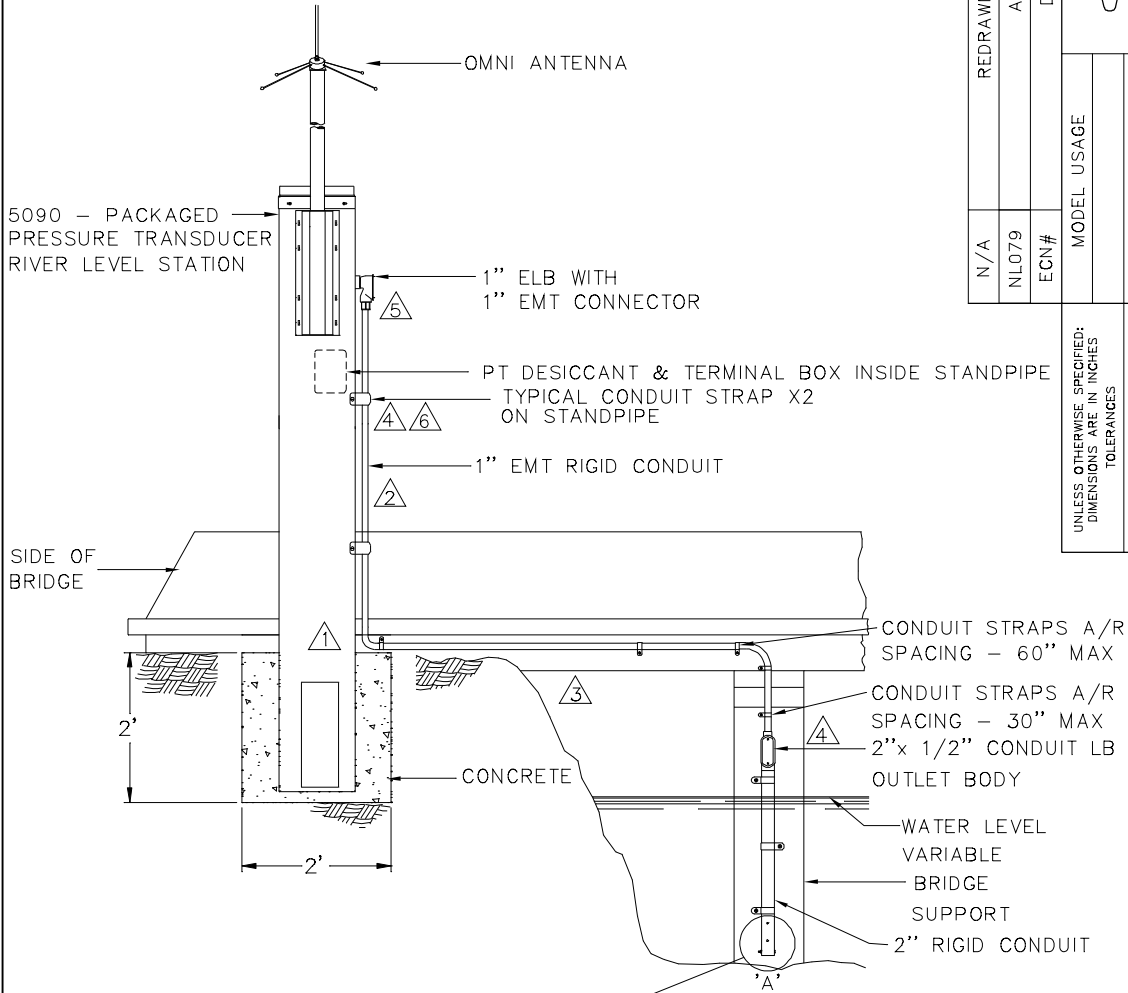

A- 1/4 THRU X8
 TWO SETS OF FOUR HOLES
 AT 90 SPACING

2" RIGID CONDUIT
 1/4-20 x 3.0 SS HEX-HEAD
 BOLT WITH 1/4" HELICAL SPRING
 LOCKWASHERS SS & 1/4 HEX NUT SS
 ACROSS CENTER OF OPEN END

N/A	REDRAWN ON NEW BORDER	5/28/99
NL079	ACAD REDRAW	2/2/96
ECN#	DESCRIPTION	DATE
MODEL USAGE		
UNLESS OTHERWISE SPECIFIED: DIMENSIONS ARE IN INCHES TOLERANCES		
FRACTIONS = ϵ N/A		
.XX = ϵ .01		
.XXX = ϵ .005		
WATL		
FINISH		
TREATMENT		
	HydroLynx	
	MODEL NO.	5090
	TITLE	TYPICAL BRIDGE CONFIGURATION
	DWG TYPE	B
	DATE	5/28/99
	INSTALLATION	AC104747
	DWG NO.	B
	REV	B
	DRAWN BY	R. BURKE
	CHECKED BY	

- NOTES
1. RIGID CONDUIT MUST BE USED FOR ALL BURIAL APPLICATIONS.
 2. 1" CONDUIT SHOWN. OTHER DIAMETERS MAY BE USED.
 3. LENGTH OF CONDUIT IS DETERMINED BY SITE REQUIREMENTS.
 4. CONDUIT AND STRAPS ARE FURNISHED AND INSTALLED BY CUSTOMER.
 5. POSITION OF ELB BOX MAY VARY.
 6. INSTALL STANDPIPE CONDUIT STRAPS USING SHEET METAL SCREWS. SEAL SCREW HOLES AND SCREW HEADS WITH RTV.
 7. GABION IS FURNISHED AND INSTALLED BY CUSTOMER.
 8. PT IS INSTALLED AND REMOVED FROM OPEN OF 2" PIPE

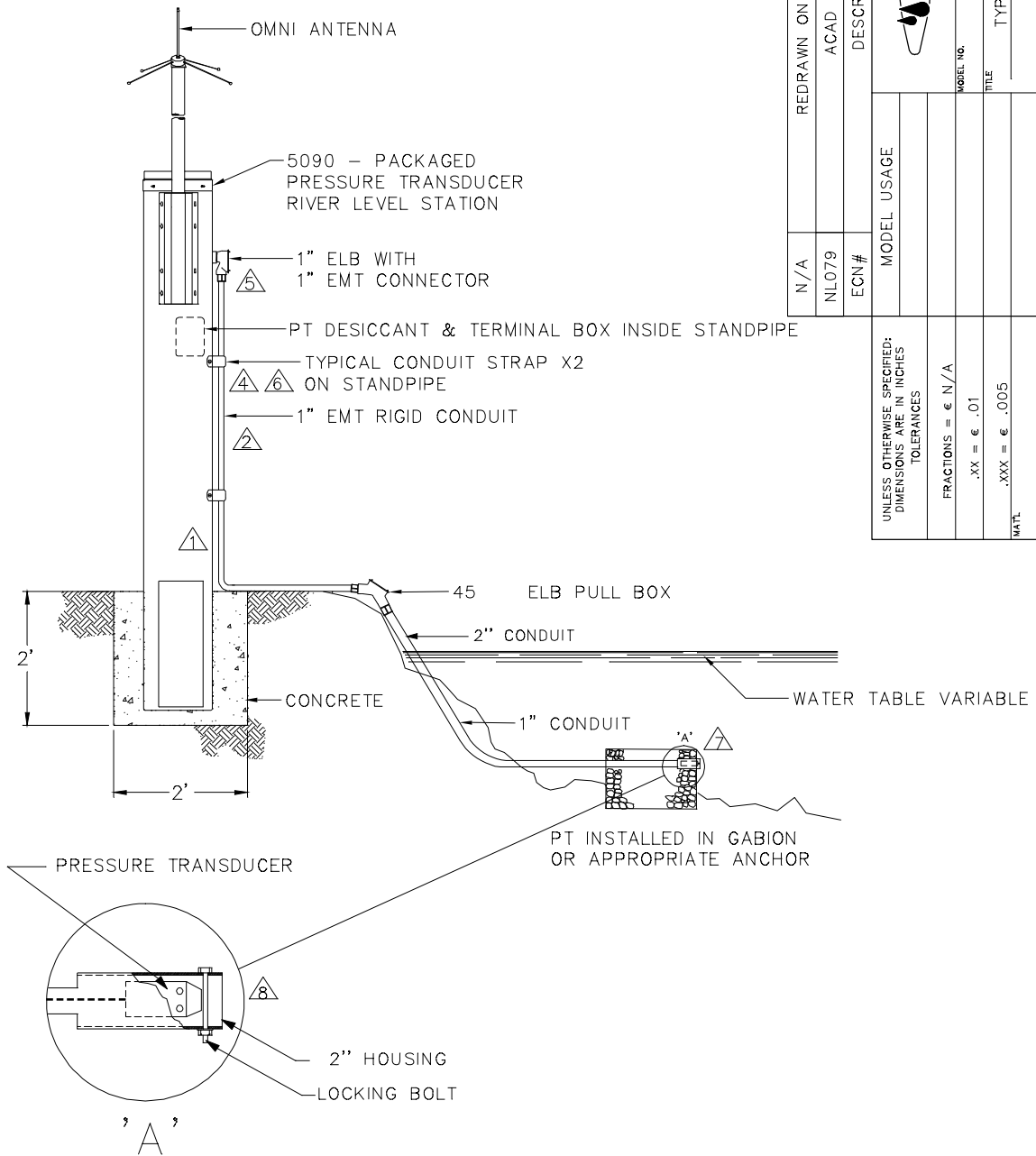

N/A	REDRAWN ON NEW BORDER	5/28/99
NL079	ACAD REDRAW	2/2/96
ECN #	DESCRIPTION	DATE
HydroLynx		
MODEL USAGE	MODEL NO.	5090
UNLESS OTHERWISE SPECIFIED: DIMENSIONS ARE IN INCHES TOLERANCES	TITLE	TYPICAL RIVER BANK CONFIGURATION
FRACTIONS = ϵ N/A	DWG TYPE	INSTALLATION
.XX = ϵ .01	DATE	5/28/99
.XXX = ϵ .005	SIZE	B
MATL	DRAWN BY	J. MICHAELS
FINISH	CHECKED BY	
TREATMENT	FIG NO.	AC102497
	REV	B

- NOTES
1. RIGID CONDUIT MUST BE USED FOR ALL BURIAL APPLICATIONS.
 2. 1" CONDUIT SHOWN. OTHER DIAMETERS MAY BE USED.
 3. LENGTH OF CONDUIT IS DETERMINED BY SITE REQUIREMENTS.
 4. CONDUIT AND STRAPS ARE FURNISHED AND INSTALLED BY CUSTOMER.
 5. POSITION OF ELB BOX MAY VARY.
 6. INSTALL STANDPIPE CONDUIT STRAPS USING SHEET METAL SCREWS. SEAL SCREW HOLES AND SCREW HEADS WITH RTV.
 7. ANCHOR BLOCK IS FURNISHED AND INSTALLED BY CUSTOMER.

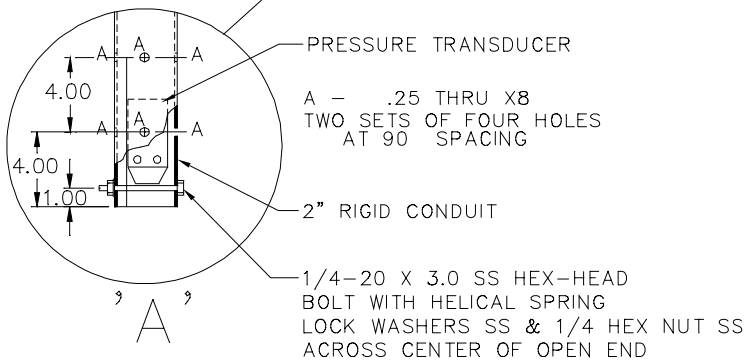
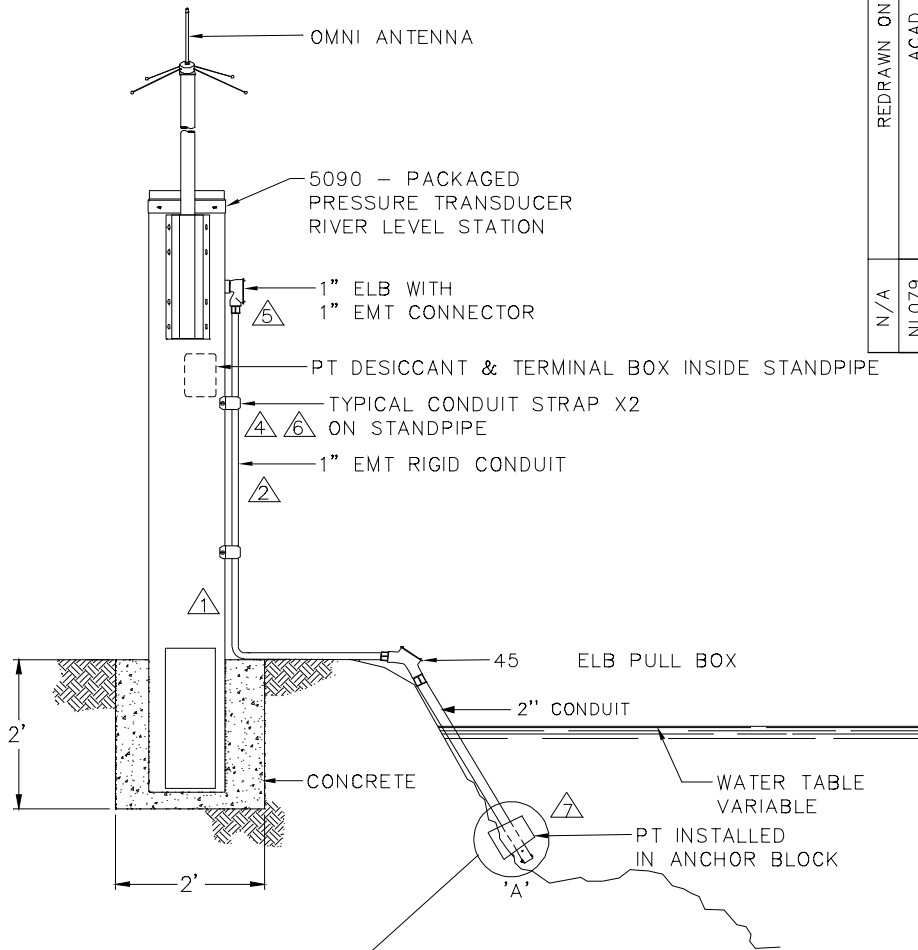



N/A	REDRAWN ON NEW BORDER	5/27/99
NL079	ACAD REDRAW	2/2/96
ECN#	DESCRIPTION	DATE
HydroLynx		
MODEL USAGE		MODEL NO. 5090
UNLESS OTHERWISE SPECIFIED: DIMENSIONS ARE IN INCHES TOLERANCES		TITLE TYPICAL RIVER BANK CONFIGURATION
FRACTIONS = € N/A		DWG TYPE INSTALLATION
.XX = € .01		DATE 3/27/99
.XXX = € .005		SIZE B
MATERIAL		DWG NO. AC102504
FINISH		REV B
TREATMENT		
DRAWN BY J. MICHAELS		CHECKED BY

NEMA 4X
ENCLOSURE
(1522 OR 5050LL-PTK)

INSTALLATION NOTES:

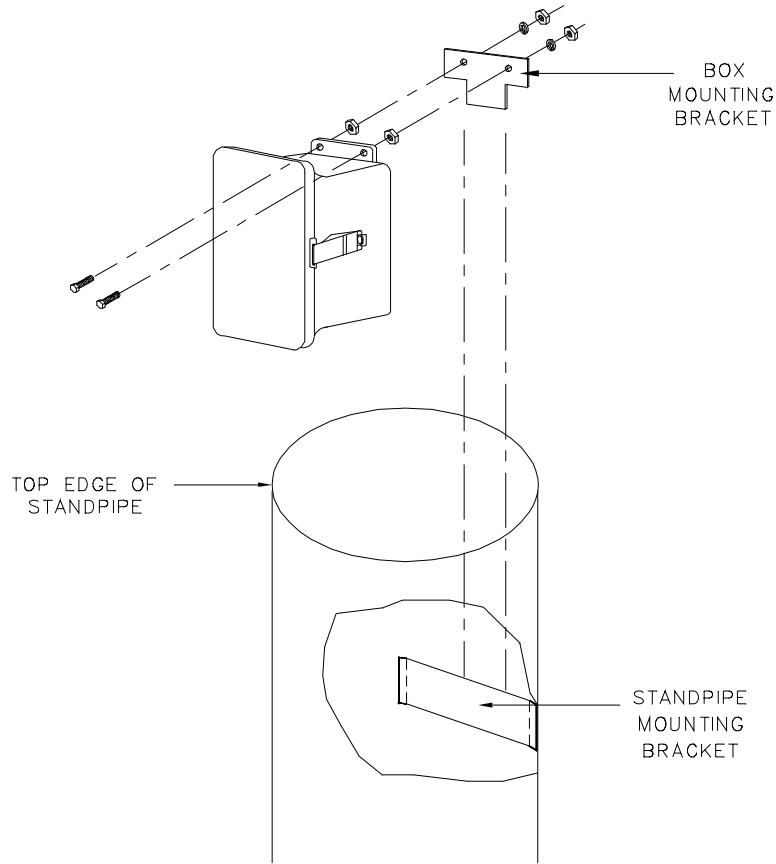
1. MOUNT BOX BRACKET ONTO BOX FLANGE AS SHOWN.
2. LOWER BOX AND BRACKET INTO STANDPIPE.
3. SLIDE TAB OF BOX BRACKET DOWN AND BEHIND STANDPIPE BRACKET.
4. NEMA 4X BOX RESTS IN FRONT OF STANDPIPE BRACKET.



MODEL USAGE				
1522, 5050LL-PTD				
		MODEL NO.	5081, 5090	
		TITLE	ENCLOSURE / STANDPIPE	
DRAWN BY	DATE	DWG TYPE		
K.KOELSCH	3/10/99	INSTALLATION		
CHECKED BY	DATE	SIZE	DWG NO.	REV
		A	AC107807	A



SCADALYNX
50386
Data Collection Unit

Operating Manual

WD102711-14

Receiving and Unpacking

Carefully unpack all components and compare to the packing list. Notify HydroLynx Systems immediately concerning any discrepancy. Inspect equipment to detect any damage that may have occurred during shipment. In the event of damage, any claim for loss must be filed immediately with the carrier by the consignee. If the equipment was shipped via Parcel Post or UPS, contact HydroLynx Systems for instructions.

Returns

If equipment is to be returned to the factory for any reason, call HydroLynx between 8:00 a.m. and 4:00 p.m. Pacific Time to request a Return Authorization Number (RA#). Include with the returned equipment a description of the problem and the name, address, and daytime phone number of the sender. Carefully pack the equipment to prevent damage during the return shipment. Call HydroLynx for packing instructions in the case of delicate or sensitive items. If packing facilities are not available, take the equipment to the nearest Post Office, UPS, or other freight service and obtain assistance with packaging. Please write the RA# on the outside of the box.

Warranty

HydroLynx Systems warrants that its products are free from defects in material and workmanship under normal use and service for a period of one year from the date of shipment from the factory. HydroLynx Systems' obligations under this warranty are limited to, at HydroLynx's option: (i) replacing; or (ii) repairing; any product determined to be defective. In no case shall HydroLynx Systems' liability exceed product's original purchase price. This warranty does not apply to any equipment that has been repaired or altered, except by HydroLynx Systems, or that has been subjected to misuse, negligence, or accident. It is expressly agreed that this warranty will be in lieu of all warranties of fitness and in lieu of the warranty of merchantability.

Address

HydroLynx Systems, Inc.
950 Riverside Pkwy., Suite 10
West Sacramento, CA 95605
Phone: (916) 374-1800
Fax: (916) 374-1877
E-mail: hydro@hydrolynx.com

Copyright © 2011 HydroLynx Systems, Inc.

ALERT2 technology has been licensed from Blue Water Design LLC.

Table of Contents

1	INTRODUCTION	7
1.1	Organization of the Manual	8
1.2	Catalog Specification Sheets	9
2	HARDWARE	21
2.1	General Description	23
2.2	PC On a Stick® (PCOS)	23
2.3	ScadaLynx Board (SLB)	23
2.3.1	Sensor Inputs - I/O Points	23
2.3.1.1	Sensor Data	23
2.3.1.2	Digital I/O	24
2.3.1.3	Analog Inputs	25
2.3.1.4	SDI-12	26
2.3.2	Manual I/O Features	26
2.3.2.1	Switches	27
2.3.2.2	LEDs	28
2.3.2.3	Test Points	29
2.3.2.4	Jumpers	29
2.3.2.5	ALERT Audio Out Adjust	29
2.3.3	Interface Connectors	29
2.3.3.1	Power	30
2.3.3.2	Telemetry	30
2.3.3.3	Console	31
2.3.3.4	I/O	31
2.3.3.5	Expansion	31

Table of Contents

2.4	Configurations	32
2.4.1	Can	32
2.4.1.1	Data Transmitter	32
2.4.1.2	Data Repeater	32
2.4.2	NEMA Box	33
2.4.3	Desktop	33
2.4.4	Expansion	34
2.5	Installations	34
2.5.1	Unpack and Visual Inspection	34
2.5.2	Bench Check	34
2.5.3	Initial Gauge Installation	34
2.5.4	In Situ Connections	34
2.5.5	In Situ Testing	35
2.5.6	Final Gauge Installation	35
3	SOFTWARE	37
3.1	General Description	38
3.1.1	50386 DCU Software Operations	38
3.1.1.1	Operating System (DOS)	38
3.1.1.2	Application Program (Lynx386.exe)	38
3.1.1.3	Configuration Files (filename.cfg)	38
3.1.2	Console Setup	39
3.2	DOS	39
3.2.1	File Transfer - Send	39
3.2.2	File Transfer - Receive	40

Table of Contents

3.3	RUN	40
3.3.1	Monitor	40
3.3.2	Command List	41
3.3.3	Command Key Action	41
3.4	PROGRAM	46
4	MAINTENANCE, TESTING and TROUBLESHOOTING	
4.1	Maintenance	48
4.1.1	Routine Maintenance	48
4.1.2	Maintenance Report	48
4.2	Testing	49
4.2.1	Power-up/Reset Test: LED Sequence	49
4.2.2	Level 1 Test: Test Switch	49
4.2.3	Level 2 Test: Program Monitor	50
4.2.4	Level 3 Test: ToolBox Data & Test Tabs	50
4.2.5	Receiver Test	50
4.2.5.1	RX Audio Out: P5 pin 1	51
4.2.5.2	Carrier Detect (CD): P5 pin 7	51
4.2.5.3	RF Receive Antenna	51
4.2.6	Decoder Test	52
4.2.7	Repeater Test	52
4.2.7.1	Repeater Wait Timer	52
4.2.7.2	Talkback Wait Timer	52
4.2.7.3	Receive On During Transmit	53
4.2.7.4	Repeat ID Range Table	53

Table of Contents

4.3	Troubleshooting	53
4.3.1	The Usual Suspects: Common Failures	53
4.3.1.1	Power Failures	54
4.3.1.2	Transmission Failures	54
4.3.1.3	Sensor Failures	54
4.3.2	Troubleshooting with the Console	54
5	APPENDIX	55
5.1	DOS Commands	56
5.2	.cfg set up examples	57
5.3	Drawings	58

1 INTRODUCTION

1.1	Organization of the Manual	8
1.2	Catalog Specification Sheets	9

1.1 Organization of the Manual

This manual describes the HydroLynx Systems' ScadaLynx 50386 Data Collection Unit (DCU) and related models. The information is divided into five sections, each related to a specific aspect of the 50386 DCU:

Introduction

The Introduction section gives this summary which is intended to help the reader find specific information of interest. This section also includes the catalog sheets of the various HydroLynx 50386 DCU models and packages; these sheets give the product's general description and specifications.

Hardware

The Hardware section describes the features of the PC On a Stick (PCOS)[®] and the ScadaLynx Board (SLB) including: the sensor inputs, manual I/O features and interface connector pin configurations. Also, there are discussions on the various configurations and installation notes.

Software

This section explains the 50386 DCU as a DOS computer; and the operations of both the application program (*Lynx386.exe*) and the configuration file (*filename.cfg*).

Note: The ScadaLynx ToolBox User's Manual explains how to create *.cfg* files and send them to the 50386 DCU.

Maintenance, Testing and Troubleshooting

The information in this section is a useful guide for the service technician; it includes references to the Maintenance test procedure and the Maintenance Report outlined in the Basic Gauge Manual. This section also includes information on using the software programs as maintenance, testing and troubleshooting tools.

Appendix

The Appendix includes sections on DOS Commands, *.cfg* file examples and drawing.

1.2 Catalog Specification Sheets

Model #	Description
50386/A2	ALERT2 Data Transmitter Data Sheet
50386	ALERT2 Data Transmitter Specifications
50386RP	Repeater
50386R/D	Receiver/Decoder
5354	Packaged Rain Station
5381	Packaged Weather Station
5390	Packaged Pressure Transducer Liquid Level Station
5390WL	Wireless Lynx
5391	Packaged Water Quality Station
50386P	Packaged Repeater

MODEL 50386/A2 ALERT2 Data Transmitter

General Description

The HydroLynx Model 50386/A2 ALERT2 Data Transmitter uses the HydroLynx ALERT2 Encoder to transmit ALERT2 data reports; implementing the important design goals of ALERT2: which increases the data through-put and data flexibility while eliminating erroneous data reports. To achieve these goals, ALERT2 combines a high baud rate, state-of-the-art data encryption with Forward Error Correction (FEC), and Time Division Multiple Access (TDMA) communications. The 50386/A2 ALERT2 Data Transmitter with the ALERT2 Encoder achieves these ALERT2 design goals.

High baud rate data transmissions allow the ALERT2 data packet to include more information than standard ALERT transmissions. The data content portion of the ALERT2 data packet is designed for format flexibility; this allows various data types to be included in ALERT2 data reports. To insure reliable data transmission, via RF communication paths at a high baud rate, the data packet must include advanced data encryption with FEC. The HydroLynx Systems ALERT2 Encoder provides this ALERT2 Protocol compliant data packet. ALERT2 TDMA communications eliminates the data report collisions inherent in standard ALERT communications. TDMA communications requires the addition of a GPS antenna/receiver to insure that the transmitter's clock keeps the ALERT2 data report within the allocated TDMA time slot.

The 50386/A2 is using the same logic boards: 50386SLB and 50386PCOS, which have provided more than 10 years of reliable field performance in the 50386DCU models. The 50386 collects, processes, and transmits analog and digital sensor data. The 50386/A2 is programmable using the same 50386 Toolbox software which includes a full set of commands for data collection, data logging, and ALERT2 data transmission. With the ALERT2 data packet, the sensor data value may now be calibrated and reported in engineering units in 16 bit unsigned integer format: 0...65,535, signed integer format -32767...32767, single precision (7 decimal digit) IEEE floating point, and double precision (16 decimal digit) IEEE floating point (*ALERT data range: 0...2047*). The ALERT2 Station ID (SID) range has also increased to 1...65,534 (*ALERT format: 0...8191*). In addition to the increase in SID numbers, the ALERT2 data packet format includes individual sensors numbers (SN) for each station: 0...254. Both the SID and the SN are programmable values in the 50386A2 ALERT2 Data Transmitter.

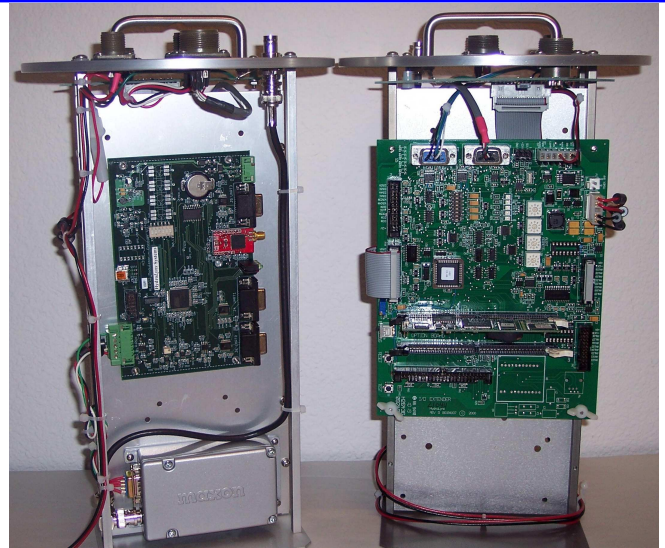

Model 50386/A2 ALERT2 Data Transmitter

Model 50386/A2-UP ALERT2 Upgrade

The Model 50386/A2-UP ALERT2 upgrade includes the HydroLynx Systems ALERT2 Encoder, a GPS antenna/receiver with lightning arrestor, and a *lynx386.exe* Version 2-XX-XX application program upgrade.

The HydroLynx Systems ALERT2 Encoder installed between the 50386SLB PCB and the radio provides an ALERT2 Protocol compliant data packet. The GPS antenna/receiver insures that the transmitter's clock keeps the ALERT2 data report within the allocated TDMA time slot. The *lynx386.exe* Version 2-XX-XX application program along with the encoder upgrade allows the same 50386 models that have provided more than 10 years of reliable field performance to collect, process, and transmit ALERT2 data.

HydroLynx Systems recommends including a 5033-0.6B Solar Panel along with an 18 amp/hr battery at all sites using the 50386/A2 ALERT2 Data Transmitter.

Contact HydroLynx Systems for additional information, procedures or details on the ALERT2 upgrade. ALERT2 technology has been licensed from Blue Water Design LLC.

Ordering Information

50386/A2-54.....Transmitter in Round Canister, 1 Precipitation Input
50386/A2-88.....Same as 50386-54 with 2 Digital Inputs
50386/A2-90.....Same as 50386-54 with 2 Digital & 1 Analog Inputs
50386/A2-81.....Same as 50386-54 with 3 Digital & 7 Analog Inputs
50386N/A2Transmitter in NEMA 4X Enclosure
50386/A2-UP.....Alert2 Upgrade to existing 50386 Data Transmitter

Specifications

PCOS

Processor:..... Intel 80386EX
 Clock Speed:..... 33 MHz
 Bus size:..... 16 bits
 Serial bus:..... I²C
 FLASH memory:..... 4 MB
 EEROM memory:..... 8 kB
 RAM memory:..... 1 MB

PIC I/O Processor

Clock Speed:..... 20 MHz
 Communication bus:..... I²C

Communications

Serial ports:..... 2 RS232 standard
 Serial port expansion:..... 4 RS232 additional
 ALERT radio:..... Transmit/receive
 ScadaLynx radio:..... Transmit/receive
 Protocols:..... ALERT, ScadaLynx, MODBUS,
 GOES, other protocols available
 Internal telephone modem:..... Option

Analog Inputs

Number of external inputs:..... 16 (14 available, 2 reserved for on
 board voltage measurement)
 Resolution:..... 16-bits
 Input Ranges:..... 0 to 5 Vdc or 4 to 20 mA with resistor
 Absolute error:..... 0.0015%
 Linearity error:..... 0.003%
 Ref. temperature stability:..... 5 ppm/°C

Up/Down Counter Inputs

Number of inputs:..... 4
 Low speed input types:..... Form C, contact closure, direction line
 Maximum input rate:..... 100 Hz
 Input noise filtering:..... 200 kHz (-3 dB)

High Speed Counter Inputs

Number of inputs:..... 4
 High speed input types:..... AC, 5 Vdc
 Maximum input rate:..... 2 kHz
 Input noise filtering:..... 5 kHz (-3 dB)

Digital Inputs

Number of inputs:..... 12
 I/O types:..... Contact closure and 5 Vdc
 Input noise filtering:..... 15 Hz (-3 dB)

Digital Outputs

Number of outputs:..... 6
 I/O types:..... Low side, Open drain
 Output capacity:..... 50 Vdc and 150 mA DC continuous sink
 current

SDI-12 Input

Input pins:..... Signal, Gnd, 12 Vdc

Power Required (not including optional hardware and/or boards)

Fully asleep:..... 10 to 16 Vdc, < 3 mA
 Fully awake:..... 10 to 16 Vdc, < 150 mA

Switched Power Supply

5 Vdc sensor power:..... 30 mA, maximum
 12 Vdc sensor power:..... 500 mA, maximum
 12 Vdc radio power:..... 6 A maximum
 12 Vdc radio power amplifier: 5 A maximum

General

Operating temperature:..... -40 to 85 °C
 Humidity:..... 0 to 95%, non-condensing

Models 50386-54, 90, 81

Enclosure:..... Aluminum canister
 Size:..... 8 in. diameter x 23 in. high
 Weight:..... 19 lbs with battery
 Shipping weight:..... 12 lbs (battery shipped separately)
 Sensor inputs:..... Keyed MS male connectors
 50396-54..... 1 Precipitation Input, 1 SDI-12 Input
 50386-90..... 1 Precipitation Input, 1 Up/Down
 Counter Input, 2 Analog Inputs,
 1 SDI-12 Input
 50386-81..... 1 Precipitation Input, 1 Up/Down
 Counter Input, 7 Analog Inputs,
 2 Wind Inputs, 1 SDI-12 Input
 Battery:..... 12 Vdc, 18 Amp-hour rechargeable gel cell
 External 12 Vdc connector:..... 3 pin MS male connector for solar panel
 or optional AC charger
 Antenna:..... BNC female bulkhead
 Serial ports (2):..... 7 pin MS male external connector,
 9 pin DB9 male connector on board

Models 50386N, N-2, NZ, and N-CP

Enclosure:..... NEMA-4X fiberglass
 Size:..... 15.5 in. x 13.5 in. x 6.5 in.
 Weight:..... 16 lbs with battery
 Shipping weight:..... 12 lbs (battery shipped separately)
 Sensor inputs:..... Enclosure with 7 cable strain reliefs
 Connections:
 50386N:..... Screw terminal interconnect PCB for
 2 Up/Down Counter Inputs, 7 Analog
 Inputs, 2 High Speed Counter (wind)
 Inputs, 8 Digital Inputs, 2 Digital
 Outputs, 1 SDI-12 connector onboard
 50386N-2:..... Same as 50386N with 2 Antenna
 Connectors
 50386NZ:..... Screw terminal interconnect PCB for
 4 Up/Down Counter Inputs, 14 Analog
 Inputs, 4 High Speed Counter (wind)
 Inputs, 12 Digital Inputs, 6 Digital
 Outputs, 1 SDI-12 connector onboard
 50386N-CP:..... Keyed MS male connectors for 2 Up/Down
 Counter Inputs, 7 Analog Inputs, 2 Wind
 Inputs, 8 Digital Inputs, 1 SDI-12 MS
 connector
 Battery:..... 12 Vdc, 18 Amp-hour rechargeable gel cell
 External 12 Vdc connector:..... 3 pin MS male connector for solar panel
 or optional AC charger
 Antenna:..... N-type female lightning arrestor
 Serial ports (2):..... 9 pin DB9 male connector on board

Options

RTR..... Radio Link (Specify frequency)
 5073TBX..... 50386 Toolbox Software
 50386-OP1 7 Pin MS Male RS232 Connector
 50386-OP2 10 Pin MS Female Digital Status Connector
 50386-OP3 3 Pin MS Male SDI-12 Connector
 50386-OP4 6 Serial Port Expansion
 50386-OP5 Leased Line Modem
 50386-OP6 Internal Power Supply
 50386-OP7 GOES Radio
 50386-OP8 ScadaLynx Radio
 50386-OP9 Microwave Interface
 50386-OP10 GOES Antenna
 50386-OP11 Industrial Dial-up Modem
 50386-OP12 Digital Input Expansion
 50386-OP13 Analog/Digital Output
 50386-OP14 Network Connector

MODEL 50386RP Repeater

General Description

The HydroLynx Model 50386RP Data Repeater is an intelligent repeater that performs the same role as an ALERT repeater while adding the utility of the 50386. An ALERT repeater is used to relay data from a remote site to the central site where a direct line-of-sight radio path does not exist. The 50386RP adds multiple communication pathways and sensor inputs.

As an intelligent repeater, the 50386RP decides to repeat data reports based on three criteria: 1) the report is a valid message, 2) the ID number is in the programmable Repeat Range list, and 3) the same report is NOT in the Talk Back Buffer. The ScadaLynx Toolbox software package is used to configure all of the 50386 programmable parameters; this allows the user to reconfigure the Repeat Range list in the field. A sensor ID offset value can also be added to a sensor report before it is repeated.

The multiple communication pathway feature allows data repeating with different types of telemetry equipment, each employing its own communication protocol. Communication configurations include the standard ALERT repeater types: single frequency store and forward, and dual frequencies for simultaneous receive and transmit capability. Examples of additional configurations include OES transmitters, two-way SCADA radios, telephone modems and microwave relays.

On-site data collection capability is accomplished with sensor input packages that can add up to 14 analog inputs, four low speed counters (rain sensor inputs), four high speed counters (AC or DC wind inputs), twelve digital status inputs, six digital outputs and an SDI-12 port.

Specifications

General

Output power:
 RTR only:..... 5 Watts
 RTR with RPA:..... 20 Watts
 Standby Current:..... 65 mAmps
 Transmit Current Drain:
 RTR only:..... 2 Amps
 RTR with RPA:..... 7 Amps
 Repeater processor:..... See 50386 specifications
 Radio specifications:..... See RTR specifications
 Power Amp specifications:..... See RPA specifications

Model 50386RP

Enclosure:..... Aluminum canister
 Size:..... 8 in. diameter x 23 in. high
 Weight:..... 25 lbs with battery
 Shipping weight:..... 12 lbs (battery shipped separately)
 Sensor inputs:..... Keyed MS connectors
 Battery:..... 12 Vdc, 18 Amp-hour rechargeable gel cell
 External 12 Vdc connector:..... 3 pin MS male connector
 Antenna:..... BNC female bulkhead connector
 Serial port:..... 7 pin MS male connector

Models 50386RP-B and 50386RP-N

Enclosure:..... NEMA-4X fiberglass
 Size:..... 5.5 in. x 13.5 in. x 6.5 in.
 Weight:..... 25 lbs with battery
 Shipping weight:..... 12 lbs (battery shipped separately)
 Sensor Inputs:..... Enclosure with cable strain reliefs and screw terminal interconnect PCB or keyed MS connectors
 Battery:..... 12 Vdc, 18 Amp-hour rechargeable gel cell
 External 12 Vdc connector:..... Two 3 pin MS male connectors
 Antenna:..... N-type female lightning arrestor
 Serial ports:..... Two onboard DB9 male connectors

Model 50386RP-K

Enclosure:..... Aluminum 4U Rack Mount with handles
 Size:..... 19 in. x 8.75 in. x 13 in.
 Weight:..... 26 lbs with battery
 Shipping weight:..... 13 lbs (battery shipped separately)
 Battery:..... 12 Vdc, 18 Amp-hour rechargeable gel cell
 External 12 Vdc connector:..... Two 3 pin MS male connectors
 Antenna:..... N-type female lightning arrestor
 Serial ports:..... Two onboard DB9 male connectors

Ordering Information

50386RP..... Repeater in Round Canister with 1 Antenna Connector
 50386RP-2..... Same as 50386RP with 2 Antenna Connectors
 50386RP-54..... Same as 50386RP with 1 Precipitation Input, 1 SDI-12 Input
 50386RP-90..... Same as 50386RP with 1 Precipitation Input, 1 Up/Down Counter Input, 2 Analog Inputs, 1 SDI-12 Input
 50386RP-81..... Same as 50386RP with 1 Precipitation Input, 1 Up/Down Counter Input, 7 Analog Inputs, 2 Wind Inputs, 1 SDI-12 Input
 50386RP-B..... Repeater in NEMA 4X Enclosure with 1 Antenna Connector
 50386RP-B2..... Same as 50386RP-B with 2 Antenna Connectors
 50386RP-N..... Same as 50386RP-B with 2 Up/Down Counter Inputs, 7 Analog Inputs, 2 Wind Inputs, 8 Digital Inputs, 2 Digital Outputs, 1 SDI-12 Input
 50386RP-NZ..... Same as 50386RP-B with 4 Up/Down Counter Inputs, 14 Analog Inputs, 4 Wind Inputs, 12 Digital Inputs, 6 Digital Outputs, 1 SDI-12 Input
 50386RP-N-CP..... Same as 50386RP-N with MS Connector Package
 50386RP-K..... Repeater in Rack Mount Enclosure with 1 Antenna Connector
 50386RP-K2..... Same as 50386RP-K with 2 Antenna Connectors

Specify receive and transmit radio frequencies.

Options

RTR..... Radio Link (Specify frequency)
 RPA-T..... Power Amplifier, 20 Watts @ 50% duty
 5073TBX..... 50386 Toolbox Software
 50386-OP1 7 Pin MS Male RS232 Connector
 50386-OP2 10 Pin MS Female Digital Status Connector
 50386-OP3 3 Pin MS Male SDI-12 Connector
 50386-OP4 6 Serial Port Expansion
 50386-OP5 Leased Line Modem
 50386-OP6 Internal Power Supply
 50386-OP7 GOES Radio
 50386-OP8 ScadaLynx Radio
 50386-OP9 Microwave Interface
 50386-OP10 GOES Antenna
 50386-OP11 Industrial Dial-up Modem
 50386-OP12 Digital Input Expansion
 50386-OP13 Analog/Digital Output

**MODEL 50386R/D
Receiver/Decoder**

General Description

The HydroLynx Model 50386R/D Receiver/Decoder provides an intelligent decoder that combines the effectiveness of the standard ALERT Receiver/Decoder with the utility of the 50386. The Alert Receiver/Decoder receives ALERT data transmissions from the remote site and provides an RS232 output to the central site computer. The 50386 Decoder features multiple communication pathways and the ability to process and re-format data. This enables data sharing across various data collection systems.

As an intelligent decoder, the 50386D validates the data, in the formats that are enabled, before processing the data for output. These formats include standard ALERT, Enhanced IFLOWS, ASCII text, ScadaLynx and Modbus. As part of the processing, the 50386D has a programmable list of ID numbers to compare received reports ID numbers and decide whether to output the data.

The Receiver and Decoder are housed in separate enclosures which allows the Receiver to be located near the antenna tower and the Decoder to be placed at the central site location. Locating the Receiver at the Antenna tower reduces the length of the RF transmission line and the associated RF signal loss, and eliminates the potential damage due to lightning entering the central site on the RF transmission line.

HydroLynx recommends the use of a high gain omni antenna at the central site receive tower to increase radio path fade margins. Antenna and RF transmission line cables are ordered separately (refer to the Antenna and Antenna Cable Sections).

Specifications

Model 50386R

Enclosure:..... Desktop
 Radio specifications:..... See RTR specifications
 Power Required:..... 12 Vdc
 Standby Current:..... 65 mA
 Transmit Current Drain:..... 2 Amps
 Battery:..... 12 Vdc, 12 AH
 Charger:..... 120 Vac, 0.2 A
 Antenna Input Connector(s):. N-type female lightning arrester
 Audio output:..... 800 mVpp, Typical
 Operating temperature:..... -40 to 60 °C
 Humidity:..... 0 to 95 %, non-condensing
 Size:..... 7.25 in. x 2.75 in. x 9 in.
 Weight:..... 3 lbs.

Model 50386D

Enclosure:..... Desktop
 Decoder processor:..... See 50386 specifications
 Power required:..... 10 to 16 Vdc
 Current drain:..... < 150 mA
 Input:..... 6 pin MS male Rotated
 Output:..... Two, Four or Six DB25 RS232 female
 Operating temperature:..... -40 to 85 °C
 Humidity:..... 0 to 95 %, non-condensing
 Size:..... 7.25 in. x 2.75 in. x 9 in.
 Weight:..... 3 lbs.

Ordering Information

50386R/D..... Receiver and Decoder in two desktops with AC
 Battery charger for Receiver, AC/DC Power
 Supply for Decoder and 25 ft. Interconnecting Cable
 50386R..... Receiver Only
 50386D..... Decoder Only

Specify receive radio frequencies.

Options

5073TBX..... 50386 Toolbox Software



Model 50386R/D Receiver/Decoder

MODEL 5354 Packaged Rain Station

General Description

The HydroLynx Model 5354 Packaged Rain Station combines the effectiveness of the standard ALERT 5054 Self-Reporting Rain Station with the utility of the 50386 Data Transmitter. Besides the ALERT communications port, the standard 50386 has two serial ports that provide the capability of multiple communication pathways. With the port expansion option that capability is increased to six serial ports.

Examples of the multiple communication pathways include GOES data transmission on both timed and random channels, two way SCADA protocol utilizing ScadaLynx radios, and all types of modems whether leased line, dial up, micro-wave or radio. The possible communication pathways are unlimited.

Specifications

Height:..... 12 ft. including rain gauge top section
 Diameter:..... 12 in.
 Weight:..... 70 lbs.
 Shipping weight:..... 80 lbs.

Ordering Information

5354..... Packaged Rain Station
 5054SA Standpipe Assembly
 5054SO Standpipe
 5054AM Antenna Mast
 5050A Omni Antenna, 3dB
 5054C-RG8 Antenna Cable with connectors
 5054TS Rain Gauge Top Section includes
 Model 5050P Tipping Bucket Assembly,
 Funnel and Screen
 5054LR Lifting Rope
 50386-54 Transmitter with data logging
 RTR, Specify radio and frequency
 5031-18 Gel Cell Battery, 18 AH, 12 Vdc
 5033-0.3B Solar Panel, Regulator, Mounting Bracket

Options

5054D..... Access Door for Standpipe
 5050LA..... Antenna Lightning Protection
 5054SG..... Standpipe Ground Kit
 SAM160..... Directional Antenna, 10 dB
 5073TBX..... 50386 Toolbox Software
 50386-OP2..... 10 Pin MS Female Digital Status Connector
 50386-OP4..... 6 Serial Port Expansion
 50386-OP5..... Leased Line Modem
 50386-OP6..... Internal Power Supply
 50386-OP7..... GOES Radio
 50386-OP8..... ScadaLynx Radio
 50386-OP9..... Microwave Interface
 50386-OP10..... GOES Antenna
 50386-OP11..... Industrial Dial-up Modem

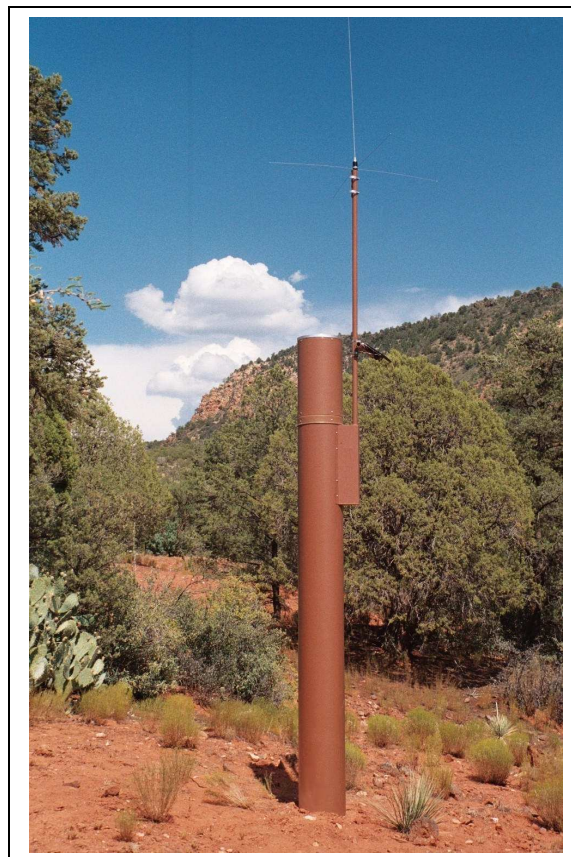

Self-Reporting Rain Station, Yavapai County, AZ

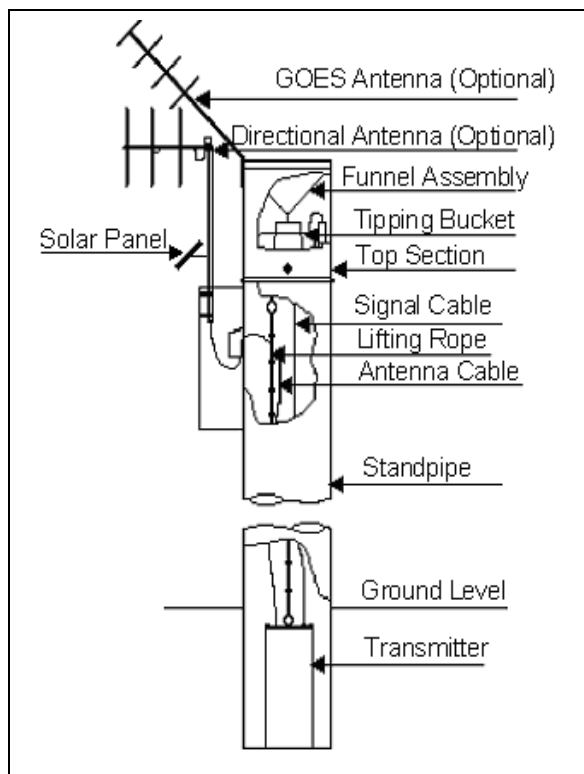

Model 5354 Self-Reporting Rain Station

MODEL 5381 Packaged Weather Station

General Description

The HydroLynx 5381 Packaged Weather Station combines the effectiveness of the standard ALERT 5081 Self-Reporting Weather Station with the utility of the 50386 transmitter. In addition to its multiple communication pathways, the 50386 features data analysis which allows data to be processed on site prior to transmission.

Processing data allows the 50386 to transmit averages, maximums, minimums and other computed values; this eliminates the transmission of large amounts of data required for these calculations at the base station. When not limited by the ALERT protocol, data in engineering units are transmitted.

The standard 5381 consists of wind, temperature, humidity, barometric pressure and precipitation sensors; 50386-81 Data Transmitter; solar panel; interconnection cables and omni antenna. An RS232 programming port and SDI-12 sensor input port are standard. The 50386 can be expanded to 16 analog inputs, 4 low speed counters (rain sensor inputs), 4 high speed counters (wind inputs), 12 digital status inputs and 6 digital outputs.

Specifications

Height:..... 14 ft., including rain gauge
 Diameter:..... 12 in.
 Weight:..... 80 lbs.
 Shipping Weight:..... 90 lbs.

Ordering Information

- 5381..... Packaged Weather Station
- 5081SA Standpipe Assembly
- 5081SO Standpipe
- 5081MX Antenna Mast and Cross Arm
- 5050A Omni Antenna, 3dB
- 5081C-RG8 Antenna Cable with connectors
- 5054TS Rain Gauge Top Section includes
 Model 5050P Tipping Bucket Assembly,
 Funnel and Screen
- 5081LR Lifting Rope
- 50386-81 Transmitter with data logging
 RTR, Specify radio and frequency
- 5031-18 Gel Cell Battery, 18 AH, 12 Vdc
- 5033-0.6B Solar Panel, Regulator, Mounting Bracket
- 1522 Barometric Pressure Sensor
- 2048RH/T Relative Humidity and
 Temperature Sensor in 4550 Shield
- 5050WS Wind Speed Sensor
- 5050WD Wind Direction Sensor

Options

- 5081D..... Access Door for Standpipe
- 5050LA..... Antenna Lightning Protection
- 5081D..... Access Door for Standpipe
- 5050LA..... Antenna Lightning Protection
- 5054SG..... Standpipe Ground Kit
- SAM160..... Directional Antenna, 10 dB
- 5073TBX..... 50386 Toolbox Software
- 50386-OP2..... 10 pin MS female digital status connector
- 50386-OP4..... 6 serial port expansion



Weather Station, San Bernardino County, CA
 50386-OP5..... Internal 2400 baud modem
 50386-OP6..... Internal power supply
 50386-OP7..... GOES radio
 50386-OP8..... ScadaLynx radio
 50386-OP9..... Microwave Interface
 50386-OP10..... GOES Antenna
 50386-OP11..... Industrial Dial-up Modem
 See sensor section for optional sensors.

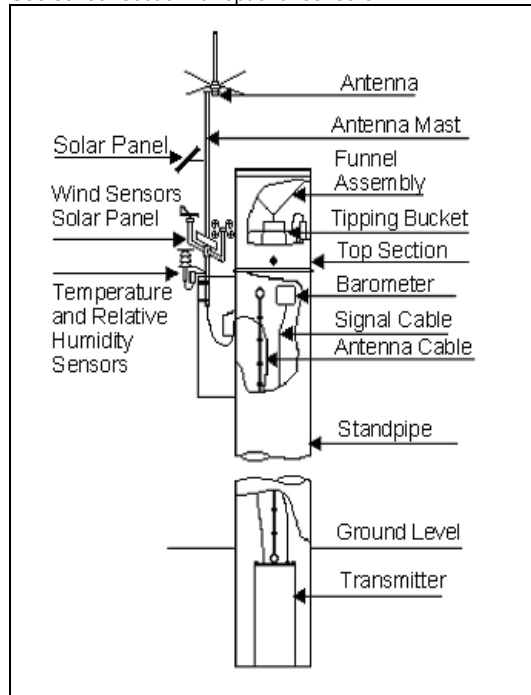

Model 5381 Self-Reporting Weather Station

MODEL 5390 Packaged Pressure Transducer Liquid Level Station

General Description

The HydroLynx Model 5390 Packaged Pressure Transducer Liquid Level Station combines the effectiveness of the ALERT 5090 Packaged Pressure Transducer Liquid Level Station with the utility of the 50386 Data Transmitter. This package includes a Model 50386-90 Data Transmitter, a 5050LL-PTD Pressure Transducer (user specified range), all cables and connectors, and a weatherproof standpipe assembly to house the transmitter and support the standard omni-directional antenna.

The 5050LL-PTD analog pressure transducer can be upgraded to a SDI-12 level sensor. SDI-12 level sensors have the advantage of a digital interface and data in engineering units. SDI-12 sensors can also be connected through a wireless link that eliminates the need for trenching and laying wires from the SDI-12 sensor to the 50386 Data Transmitter. Refer to Model 5390WL for more information.

Specifications

Height:..... 12 ft. including rain gage top section
 Diameter:..... 12 in.
 Weight:..... 70 lbs.
 Shipping Weight:..... 80 lbs.

Ordering Information

- 5390..... Packaged Pressure Transducer Station
 - 5090SA Standpipe Assembly
 - 5090SO Standpipe
 - 5090SC Standpipe Cover
 - 5050A Omni Antenna, 3dB
 - 5090AM Antenna Mast
 - 5090C-RG8 Antenna Cable with connectors
 - 5090LR Lifting Rope
 - 5090LB 1 in. Conduit Elbow Box
 - 50386-90 Transmitter with data logging
RTR, Specify radio and frequency
 - 5031-18 Gel Cell Battery, 18 AH, 12 Vdc
 - 5033-0.3B Solar Panel, Regulator, Mounting Bracket
 - 5050LL-PTD Pressure Transducer,
40 ft. Vented cable, Specify Range
- 5390/5054TS..... Packaged Pressure Transducer Station with Rain Gauge Top Section (Same as Model 5390 except 5090SC Standpipe Cover is replaced by 5054TS Rain Gauge Top Section)

Options

- 5090D..... Access Door for Standpipe
- 5050LA..... Antenna Lightning Protection
- 5054SG..... Standpipe Ground Kit
- SAM160..... Directional Antenna, 10 dB
- 5054TS..... Rain Gauge Top Section includes Model 5050P Tipping Bucket Assembly, Funnel and Screen
- 5050LL-PTD-C..... Additional Cable for Pressure Transducer
- 5390WL..... Wireless Lynx with SDI-12 level sensor
- 5073TBX..... 50386 Toolbox Software
- 50386-OP2..... 10 Pin MS Female Digital Status Connector
- 50386-OP4..... 6 Serial Port Expansion



Packaged Pressure Transducer Station, City of Loveland, CO

Options (continued)

- 50386-OP5..... Leased Line Modem
- 50386-OP6..... Internal Power Supply
- 50386-OP7..... GOES Radio
- 50386-OP8..... ScadaLynx Radio
- 50386-OP9..... Microwave Interface
- 50386-OP10..... GOES Antenna
- 50386-OP11..... Industrial Dial-up Modem

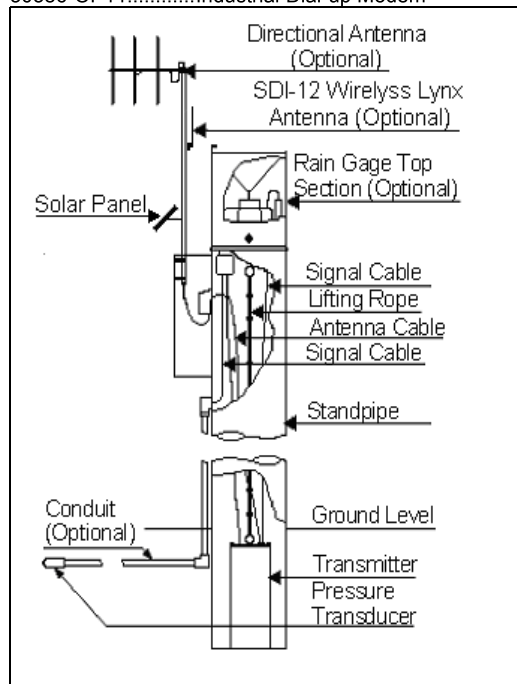

Model 5390 Packaged Pressure Transducer Station

MODEL 5390WL Wireless Lynx

General Description

The HydroLynx Model 5390WL Wireless Lynx option uses direct sequence spread spectrum radio telemetry to transmit data from a sensor to the 50386 Data Transmitter. This allows a sensor to be used at a location that is not practical for a wired sensor.

The option includes two Wireless Lynx Radios, sensor upgrade to a SDI-12 pressure transducer, an upgrade to a 600 mA solar panel at the 5390 station site, a 600 mA solar panel and 18 AH battery at the sensor site. The sensor site configuration can be changed depending on the installation requirement. Consult with a HydroLynx salesperson to discuss the available installation options.

Since ALERT systems rely on radio data telemetry, the best hydrologic site is not always a good ALERT site due to radio path problems; or due to the cost of trenching from the sensor site to the remote site standpipe; or even due to conflicts with other ALERT criteria. The 5390WL provides the ALERT user the flexibility required to install a sensor at the best hydrologic site while maximizing the remote site standpipe location for radio path or other ALERT criteria.



Wireless Link Pressure Transducer, Sacramento County, CA

Ordering Information

- 5390WL.....Wireless Lynx
 - Two Wireless Lynx Radios
 - SDI-12 Pressure Transducer
 - 5031-18 Gel Cell Battery, 18 AH, 12 Vdc
 - 5033-0.6B Solar Panel Upgrade

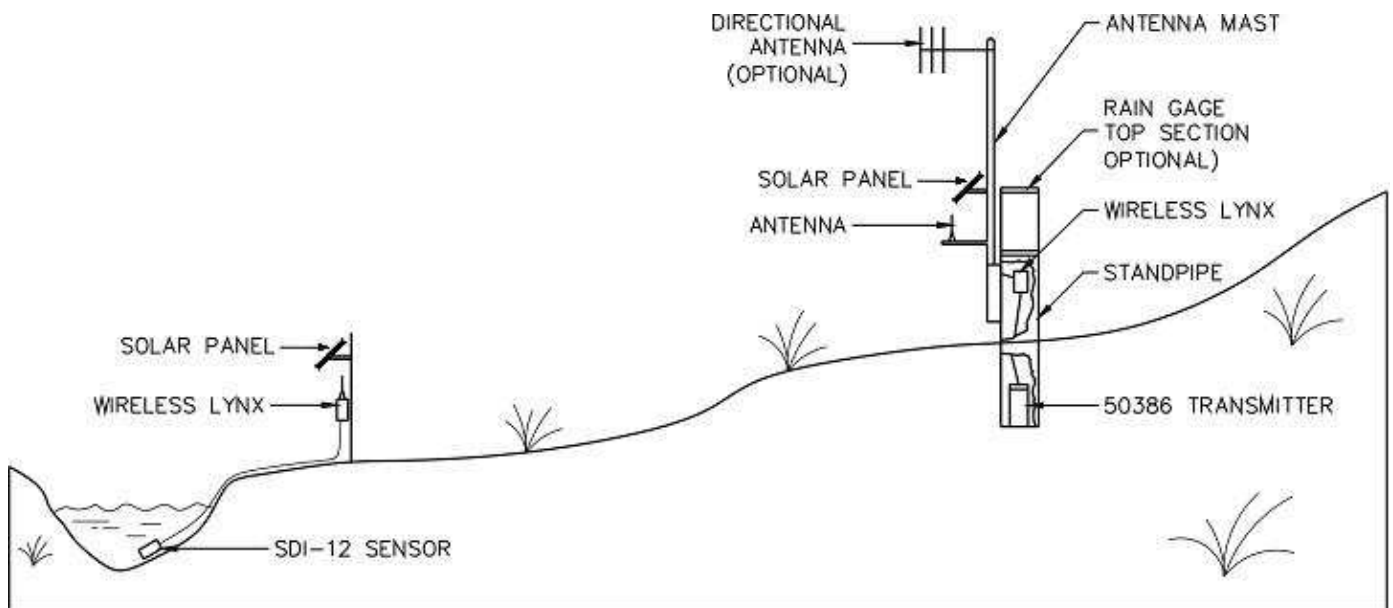

MODEL 5391 Packaged Water Quality Station

General Description

The HydroLynx 5391 Packaged Water Quality Station adds a Water Quality sensor to the 5390 Packaged Pressure Transducer Liquid Level Station. The Water Quality sensors used in this package are designed to employ up to six probes of various types. These probes include temperature, conductivity, pH, dissolved oxygen and turbidity; as well as, a variety of element specific probes. The Water Quality sensor connects to the 50396 Data Transmitter thru the SDI-12 port which allows different Water Quality sensor configurations to have a standard input interface. Consult with a HydroLynx sales person to configure this package to your specifications.

Specifications

Height:..... 12 ft. including rain gage top section
 Diameter:..... 12 in.
 Weight:..... 70 lbs.
 Shipping Weight:..... 80 lbs.

Ordering Information

5391..... Packaged Water Quality Station
 5090SA Standpipe Assembly
 5090SO Standpipe
 5090SC Standpipe Cover
 5050A Omni Antenna, 3dB
 5090AM Antenna Mast
 5090C-RG8 Antenna Cable with connectors
 5090LR Lifting Rope
 5090LB 1 in. Conduit Elbow Box
 50386-90 Transmitter with data logging
 RTR, Specify radio and frequency
 5031-18 Gel Cell Battery, 18 AH, 12 Vdc
 5033-0.6B Solar Panel, Regulator, Mounting Bracket
 5050LL-PTD Pressure Transducer,
 40 ft. Vented cable, Specify Range
 5050WQ SDI-12 Water Quality Sensor Package
 5391/5054TS..... Packaged Water Quality Station with Rain Gauge
 Top Section (Same as Model 5391 except 5090SC
 Standpipe Cover is replaced by 5054TS Rain Gauge
 Top Section)

Options

5090D..... Access Door for Standpipe
 5050LA..... Antenna Lightning Protection
 5054SG..... Standpipe Ground Kit
 SAM160..... Directional Antenna, 10 dB
 5054TS..... Rain Gauge Top Section includes Model 5050P
 Tipping Bucket Assembly, Funnel and Screen
 5050LL-PTD-C..... Additional Cable for Pressure Transducer
 5390WL..... Wireless Lynx with SDI-12 level sensor
 5073TBX..... 50386 Toolbox Software



Model 5391 Water Quality Sensor Package

Options (continued)

50386-OP2..... 10 Pin MS Female Digital Status Connector
 50386-OP4..... 6 Serial Port Expansion
 50386-OP5..... Leased Line Modem
 50386-OP6..... Internal Power Supply
 50386-OP7..... GOES Radio
 50386-OP8..... ScadaLynx Radio
 50386-OP9..... Microwave Interface
 50386-OP10..... GOES Antenna
 50386-OP11..... Industrial Dial-up Modem

MODEL 50386P Packaged Repeater

General Description

The HydroLynx Model 50386P Packaged Repeater is used to relay data from remote sites to a central site where line-of-site radio paths do not exist. The complete package includes a weather proof housing for the Model 50386RP Data Repeater, a high gain omni antenna with mast, and a solar panel. The Model 50386P is designed for fast efficient installation, with minimum environmental impact, at repeater sites where no other structures or towers are available.

A 3.0 Amp solar panel is supplied as standard. This size requires a minimum of only one sun hour per day to keep the repeater battery charged. The battery is sufficient to operate the repeater for 20 days during periods of no sun. Additional batteries can be supplied for longer periods of eligible sun.

The repeater battery voltage can be transmitted to the base station on a timed interval or when a change threshold is met. Sensor input packages add sensor connectors to the 50386 canister for on site data collection and transmission back to the base station.

Specifications

Height:..... 16 ft.
 Diameter:..... 12 in.
 Weight:..... 80 lbs.
 Shipping weight:..... 90 lbs.

Ordering Information

- 50386P.....Packaged Repeater
 - 50386RP-SA Standpipe Assembly
 - 50386RP-SO Standpipe
 - 5090SC Spun Cap
 - 50386P-AM Antenna Mast Assembly
 - DB224 or DB408 Antenna
(Specify frequency)
 - 50386C Antenna Cable
 - 50386LR Lifting Rope
- 50386RP Repeater
 - RTR, Specify radio and frequency
 - 5031-18 Gel Cell Battery, 18 AH, 12 Vdc
 - 5033-3.0B Solar Panel, Regulator, Mounting Bracket
- 50386P-2.....Same as 50386P with 2 RTRs and 2 Antenna Connectors
- 50386P-54.....Same as 50386P with 5045TS Rain Gauge Top Section
- 50386P-90.....Same as 50386P with 5050LL-PTD Pressure Transducer
- 50386P-81.....Same as 50386P with all weather station sensors

Specify transmit and receive radio frequencies.

Options

- 50386P-D.....Access Door for Standpipe
- RPA-T.....Power Amplifier, 20 watts
- 5050LA.....Lightning Protection
- 5054SG.....Standpipe Ground Kit
- 5073TBX.....50386 Toolbox Software
- 50386-OP2.....10 pin MS female digital status connector

HydroLynx Systems, Inc.
 950 Riverside Parkway, Suite 10 • West Sacramento, CA 95605-1501

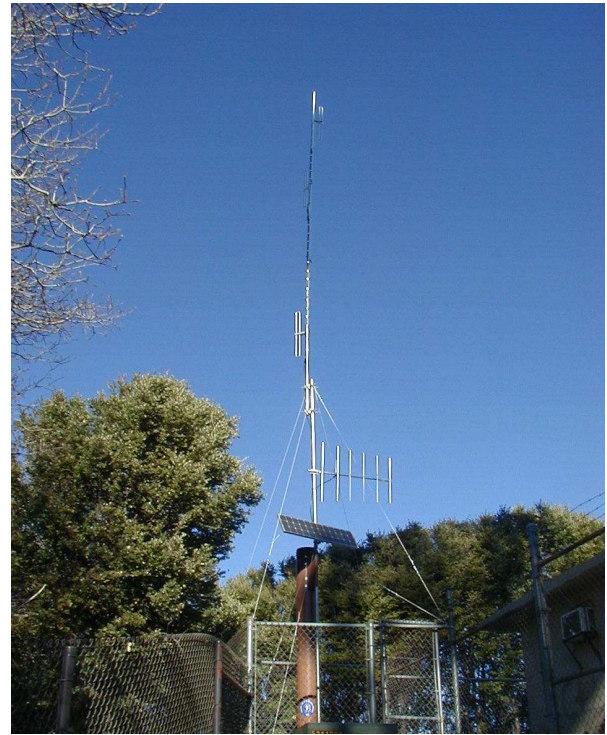

Packaged Repeater with two antennas, San Bernardino County, CA

- 50386-OP4.....6 serial port expansion
- 50386-OP5.....Internal 2400 baud modem
- 50386-OP6.....Internal power supply
- 50386-OP7.....GOES radio
- 50386-OP8.....ScadaLynx radio
- 50386-OP9.....Microwave Interface
- 50386-OP10.....GOES Antenna
- 50386-OP11.....Industrial Dial-up Modem

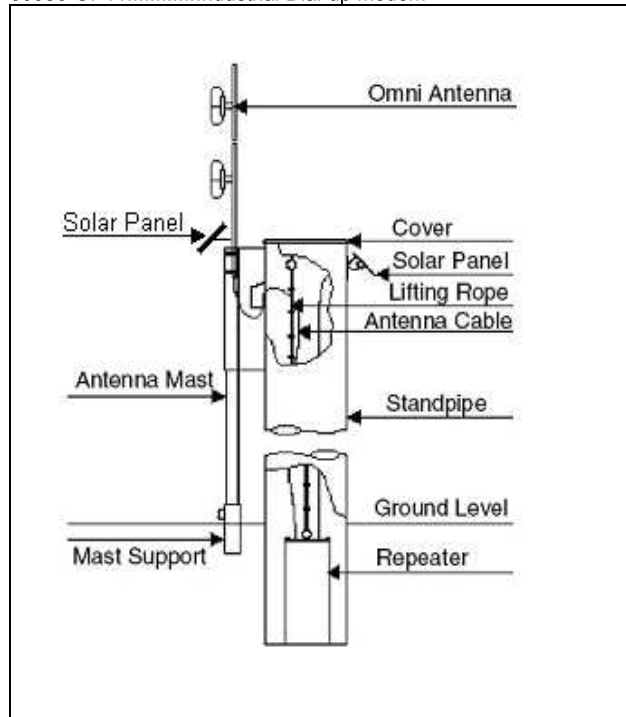

Model 50386P Packaged Repeater

2 HARDWARE

2.1	General Description	23
2.2	PC On a Stick© (PCOS)	23
2.3	ScadaLynx Board (SLB)	23
2.3.1	Sensor Inputs - I/O Points	23
2.3.1.1	Sensor Data	23
2.3.1.2	Digital I/O	24
2.3.1.3	Analog Inputs	25
2.3.1.4	SDI-12	26
2.3.2	Manual I/O Features	26
2.3.2.1	Switches	27
2.3.2.2	LEDs	28
2.3.2.3	Test Points	29
2.3.2.4	Jumpers	29
2.3.2.5	ALERT1 Audio Out Adjust	29
2.3.3	Interface Connectors	29
2.3.3.1	Power	30
2.3.3.2	Telemetry	30
2.3.3.3	Console	31
2.3.3.4	I/O	31
2.3.3.5	Expansion	31
2.4	Configurations	32
2.4.1	Can	32
2.4.1.1	Data Transmitter	32
2.4.1.2	Data Repeater	32
2.4.2	NEMA Box	33
2.4.3	Rack Mount	33
2.4.4	Expansion	34

2.5	Installations	34
2.5.1	Unpack and Visual Inspection	34
2.5.2	Bench Check	34
2.5.3	Initial Gauge Installation	34
2.5.4	In Situ Connections	34
2.5.5	In Situ Testing	35
2.5.6	Final Gauge Installation	35

2.1 General Description

The ScadaLynx 50386 Data Collection Unit (DCU) consists of the PC On a Stick[®] (**PCOS**) installed on the ScadaLynx Board (**SLB**) and a sensor interconnect board. These are packaged in various enclosures along with telemetry units (radio, modem etc) and power supplies (battery, solar charger and AC power supply) to match the user's requirements.

2.2 PC On a Stick[®] (PCOS)

The **PCOS** is a 386 DOS computer on a single board or stick. This includes a 386EX processor (with 2 onboard com ports), ROM DOS, 1MB of battery backed RAM, 4MB of Flash memory for program storage and data logging, a battery backed Real-Time Clock (**RTC**) and two LEDs which indicate functionality. Options include a memory upgrade and com port expansion to a total of six com ports.

The 386EX processor is powered up when data processing is required; otherwise, it is in sleep mode to save power.

2.3 ScadaLynx Board (SLB)

The **SLB** uses a low-power PIC processor to control its functions which include sensor inputs, timers, the ALERT1 radio port (both transmit and receive), various switches, LEDs and test points; also, connector interfaces for the **PCOS**, the two standard com ports and for the expansion boards.

The **PIC** processor wakes up the main 386EX processor whenever an event occurs or a timer expires which requires data processing.

2.3.1 Sensor Inputs - I/O Points

Sensor inputs are defined by the 50386/A2 DCU as I/O Points. Individual I/O points are configured as a specific sensor type and are programmed separately. These I/O point configurations allow the user a great deal of flexibility defining the operation of the 50386/A2 DCU in order to match system requirements.

The 50386/A2 DCU's design supports a variety of sensor types which allows for many package configurations. The types of sensors include a variety of digital, analog and serial data sensors (see section 2.4 Configurations for a description of the standard packages).

2.3.1.1 Sensor Data

For each I/O Point the 50386/A2 DCU reads sensor input and stores a Raw Value (**RAW**) and a Scaled Value (**SCALED**). The I/O point Scaling coefficients determine the **SCALED** value and can calculate data into engineering units. **SCALED** values determine test requirements for data reports and alarms.

Note: The **RAW** values are integers (with the exception of serial sensor input) while the **SCALED** values are displayed as a decimal number.

2.3.1.2 Digital I/O

Digital I/O is defined as being in one of two states; these two states are the TTL voltage levels of 0 Vdc or 5 Vdc.

Digital inputs are event driven; a transition from one level to the other will cause the PIC I/O processor to wake the 386EX processor which will process the I/O Point data. (See ScadaLynx Toolkit; Reporting; On Event)

The 50386/A2 DCU supports three types of digital inputs: Up/Down Counter (**UD**), Pulse Counter (**PC**) and Digital Inputs (**DI**) (Digital Status). There are also Digital Outputs (**DO**) available; these are used in SCADA application to remotely control equipment. Each digital input type has a unique characteristic suited to a particular application.

Up/Down Counter (**UD**)

The Up/Down Counter (**UD**) input is the standard ALERT Form "C" with Up/Down Line. The **UD** I/O Point **RAW** accumulator is incremented or decremented by one for each transition on the Form "C" inputs; the Up/Down Line determines whether to increment or decrement.

The 5050P Tipping Bucket Rain Sensor and the 5096SE Shaft Encoder are standard sensors on these inputs.

The 5050P tips each 1 millimeter (0.03937 inches) of rainfall. The **RAW** and the **SCALED** value are equal in the default programming and have an Increment Size of 1 mm per increment (**INC**).

The standard 5096SE has 100 increments per revolution and a 1 ft. pulley for an Increment Size of 0.01 ft per **INC**.

Pulse Counter (**PC**)

The Pulse Counter (**PC**) input is a modified Form "A" input; a pulse on a single input line causes a count. There are two modifications: first, there is a programmable pre-divide counter which must count down before the I/O Point's **RAW** accumulator is incremented; and second, the input can be selected as either DC pulses or AC sine wave with switch S5.

The **PC** I/O can be programmed to compute and transmit wind speed or pulse counts.

Digital Input (**DI**)

The Digital Inputs (**DI**) are 12 single input lines which represent the status of a contact closure sensor like the 5096ES Emergency Status sensor. Inputs 1 thru 8 operate on an event basis while inputs 9 thru 12 are only monitored while the 386EX processor is awake.

The 5096ES is a normally closed float switch placed at a critical water level. When the water reaches this level the float opens the switch. The 50386/A2 DCU reports the switch position as a "0" for closed and "1" for open in the ALERT2 data report.

Digital Output (DO)

The Digital Outputs (**DO**) are six single lines that act as switch closures to ground. They are controlled by the I/O point's **Alarm** tab and programmed under the **Controls** tab

2.3.1.3 Analog Input (AI)

The 50386/A2 DCU has a 16-bit Analog to Digital Converter (**ADC**) with 16 input lines. The standard input is 0-5 Vdc; 16-bits provides a **RAW** measured range of 0 to 65,535 increments (**INC**), this gives an Increment Size of 0.763 μ V per **INC**. Four other input ranges are available: 0-1 Vdc, 0-100 mVdc, 0-55 mVdc, and 0-25 mVdc.

Standard ANALOG sensors are calibrated at the factory for a 0 to 5 Vdc analog output over their measured range. An input can be converted to a 4-20 mA input with the addition of a 250 Ohm resistor inserted in the appropriate location of jumper sockets X1 and X2.

Two analog input lines are used in the standard configurations to measure onboard voltages: **AI:8** measures **Vref**, which is used with ratiometric sensors (wind direction); and **AI:16** measures the battery voltage.

The 50386/A2 DCU also provides the ability to use computations to build Analog I/O points for any analog input; some of the computations included are MAX, MIN and MEAN values over a programmed timed period.

Relative humidity, temperature, pressure transducers, barometric pressure, wind direction and battery voltages are ANALOG sensors.

The 2046RH/T has standard ranges of: 0 to 100%RH for the relative humidity sensor and -80 to 175 degrees Fahrenheit ($^{\circ}$ F) for the temperature sensor.

The 5050LL-PTD pressure transducer calibrated range is customer specified when ordered from the factory. A standard ALERT calibrated range for pressure transducers is 25.5 ft.

The 1522 barometric pressure sensor is calibrated to 100 millibars (mb) which must be offset according to the station elevation.

The 5050WD wind direction sensor is calibrated from 0 to 359 degrees.

Vref Sensor (AI:8)

The Vref sensor (**AI:8**) is used with ratiometric sensors such as the 5050WD Wind Direction sensor (**AI:7**). This type of sensors use Vref as the excitation voltage across the sensor's potentiometer (pot); the **RAW** for **AI:7** is adjusted by: $((\mathbf{AI:7} \div \mathbf{AI:8}) \times 65535)$.

Battery Sensor (AI:16)

The Battery Sensor (AI:16) uses a resistor divider network to input a voltage relative to the battery voltage by the ratio of 5 (input voltage) : 16 (battery voltage).

2.3.1.4 SDI-12 (SI)

SDI-12 is a **S**erial **D**igital **I**nterface at **1200** baud. The SDI-12 protocol allows multiple sensors to be connected to the same input port. The 50386/A2 DCU acts as the SDI-12 Master and polls the SDI-12 sensors using script commands programmed in the I/O Point configuration. The **RAW** accumulator is a floating point number instead of the integer used by other I/O Points.

Examples of where SDI-12 sensors are used include the 5390WL Wireless Lynx package and the 5391 Packaged Water Quality Station.

2.3.2 Manual I/O Features

The manual I/O features allow the user to control, monitor and test the 50386/A2 DCU functions. These features include switches, LEDs, jumpers, test points and an ALERT Audio Out Adjustment (see Drawing AC108116 for PCB locations and pin-outs).

2.3.2.1 Switches

ID Switches - S1 thru S4

Station ID selection is set in the **ID** switches with the least significant digit (ones) in switch **S4** and the highest significant digit (thousands) in switch **S1**.

For example, to set a station ID of 1930, set: **S1** to **1**, **S2** to **9**, **S3** to **3** & **S4** to **0**.

By default the ALERT2 source address is set to the station ID. Since the ALERT2 source address range is 1 – 65534. To use source addresses of 10000 or higher use the station ID offset in the configuration file.

The ALERT2 Transmitters default Sensor IDs and report type are shown here for reference (Note: the .cfg file sets the I/O points' IDs and report types)

Sensor	Sensor Name	Type	ID# offset	Report type
PK1	Peak Wind	VI	5	MSR
PK2	Peak Wind	VI	15	GSR
ST	Status	DI	9	GSR
W11	Wind Run	PC	4	MSR
CTR2	-	PC	14	GSR
EV1	Shaft Encoder	UD	17	GSR
EV2	Precipitation	UD	0	TBR
AN1	R. Humidity	AI	2	MSR
AN2	Temperature	AI	1	MSR
AN3	P. Transducer	AI	7	MSR
AN4	Barometric P.	AI	3	MSR
AN5	-	AI	27	GSR
AN6	-	AI	13	GSR
AN7	Wind Direction	AI	5	MSR
BATT	Battery Volts	AI	8	MSR
GPS	GPS Status	SI	10	GSR

Pulse Counter AC/DC Input Switch - S5

Wind speed sensors commonly use AC generators for their signal output while flow sensors and tachometers are DC pulsed output; **S5** allows the use of either sensor type on **PC** inputs.

RUN/DEBUG Switch - S6

The position of **S6** determines the mode of operation at Power-up / Reset. When **S6** is in the **RUN** position the 50386/A2 DCU will start the program listed in USER.bat (*Lynx386.exe*); in the **DEBUG** position the 50386/A2 DCU will boot-up to the DOS command prompt (**C:\>**).

RESET Switch - S7

The **RESET** switch **S7** performs the same software reboot as powering-up the 50386/A2 DCU; however, it is recommended to perform the power-up reboot when it is necessary to insure that all hardware latches are reset.

TEST Switch - S8

The **TEST** switch **S8** will initiate a test sequence that will read all I/O points and transmit data. The **TEST** switch does not wake up the 50386/A2 DCU from power down mode; pressing the **RESET** switch first will wake up the unit (wait for the PCOS LED2 to stop flashing before pressing the **TEST** switch).

2.3.2.2 LEDs

SLB:

LED#	Name	Description
1	Radio TX	Not used for ALERT2
2	Analog Power	Analog power and Vref on
3	ALERT RX	Receiving ALERT Data
4	RUN	Main 386EX processor on
5	Test	Blink when in test mode. (Note: this LED is also on for writes to the flash memory)

PCOS:

LED#	Name	Description
1	Red	Run
2	Green	Comms

2.3.2.3 Test Points

The test point numbers, names, labels and descriptions are:

TP	Name	Label	Description
1	Tx Data	TP4 or X5	RF transmit data stream (audio to the radio).
2	Battery	TP2	Battery voltage should be 12.5 - 14.0 Vdc
3	VREF	X2:1	Switched reference voltage AI:8.
5	Ground	TP3	Ground reference point.
6	Vcc	TP1 or D4	+5 Vdc power for the logic circuits.

2.3.2.4 Jumpers

Jumper blocks include the analog input blocks X1 & X2, COM port jumper X3 & X4; and the ALERT output enable jumper X5.

X1 & X2 jumper block are used to install 250 Ohm resistors for 4-20mA inputs. They also make convenient test points for analog input signals.

X3 & X4 are factory set to EN.

X5 is factory set for ALERT Audio Output.

2.3.2.5 ALERT Audio Out Adjust - R44

R44 is factory set to the correct audio output level for the radio installed on the 50386/A2 DCU.

2.3.3 Interface Connectors

The Interface Connectors are compatible with ALERT 5096 Data Transmitter where possible including the Power, Analog and Digital connectors. The radio connector has one extra pin for use with ALERT Receivers. Console interface for programming and monitoring, SDI-12 and expansion connectors.

2.3.3.1 Power - P2

Power 5-pin:

Pin	Name	Description
1	12 Vdc	Battery “+”
2	12 Vdc	12 Vdc In
3	N/C	N/C
4	Gnd	Battery “-”
5	Gnd	Ground

2.3.3.2 Telemetry

ALERT Radio - P5:

Pin	Name	Description
1	TX	Audio out
2	PTT	Key transmission
3	TX-PWR	Transmitter switched power
4	RX-PWR	Receiver power
5	RX	Audio in
6	GND	Ground
7	RX-CD	Receiver carrier detect

Power Amp - P1

Pin	Name	Description
1	5Amp	Switch Power
2	Gnd	Ground

2.3.3.3 Console - COM1 P8, COM2 P12

Pin	Name	Description
1	CD	Carrier Detect (Not used)
2	RXD	Receive Data, serial in
3	TXD	Transmit Data, serial out
4	DTR	Data Terminal Ready
5	GND	Signal Ground
6	DSR	Data Set Ready
7	RTS	Request to Send (Not used)
8	CTS	Clear to Send
9	RI	Ring Indicator (Not used)

2.3.3.4 I/O

Digital & Analog Ribbon connector interfaces connect the sensor interface board to the **SLB** (refer to schematic drawings AC104010 & AC104016 for pin outs).

SDI-12

3-pin Screw Terminal

Pin	Name	Description
1	SDI	SDI Data
2	+12V	12 Vdc Power
3	Gnd	Ground

2.3.3.5 Expansion

Bus Connector P10

The Communication Expansion Board is an options board that adds four COM ports.

I/O Extender P11

The I/O Expansion Board is an optional board that extends I/O capabilities.

2.4 Configurations

The 50386/A2 DCU is designed to fill the role of the ALERT2 Data Transmitter, Repeater and Receiver/Decoder. The design expands that role to include additional I/O capabilities, such as an SDI-12 port for interface to smart and/or wireless sensors; multiple communications pathways which add satellite radio and radio modems capability; and controlled outputs for SCADA application. Descriptions of standard configurations and their package specifications are included in section 1.2 Catalog Specification Sheets; however the versatility and expansion possibilities of the 50386/A2 DCU necessitate adaptable and custom configurations.

2.4.1 Can

The can configurations are based on the standard ALERT remote gauges and repeater package.

2.4.1.1 Data Transmitter

The standard top plate sensor connector packages, with the addition of the SDI-12 connector, are available with the 50386/A2 DCU including: rain only, 50386/A2-54; stream, 50386/A2-90; and weather, 50386/A2-81 (see drawings AC104180, AC108149 and AC108150 for pin outs). The connectors are the standard ALERT Bulkhead Mounted MS connectors with rotated and non-rotated orientations.

The console connector is a 7-pin MS bulkhead; use HydroLynx cable 5071-50386/A2-4 (see drawing # AC108148).

An SMA GPS antenna connector is provided on the top plate with the GPS antenna cable.

When a second telemetry communication port is required, for use with a GOES Satellite Radio or ScadaLynx Radio Modem, a BNC connector is added to the top plate.

2.4.1.2 Data Repeater

The 50386RP Data Repeater is configured with either one or two antenna ports and any of the sensor connector packages may be added. The repeater configuration includes many useful programmable features, such as: ID Number Pass Blocks, Talkback Wait timer, Repeat Wait timer and Receive On During Transmit function (used with two antenna ports only). These features are fully described in the ScadaLynx ToolBox Manual.

The single antenna port repeater is a Store & Forward type while the dual antenna port repeater, when programmed for Receive On During Transmit, acts like a Straight-Thru type but with the same programmable features of the Store & Forward.

An SMA GPS antenna connector is provided on the top plate with the GPS antenna cable.

2.4.2 NEMA Box

The NEMA Box configuration, 50386N, will vary dependant upon system requirements. The box will be sized to accommodate the sensor input connector packages, communications equipment and power supplies.

The sensor input connector packages are PCB mounted screw terminal connectors. The type and number of inputs can be expanded as required by adding a second standard connector package or any number of option boards. The signal cables are brought into the box through strain reliefs either in the NEMA box wall or optional electrical conduit boxes, which is determined by the number of cables.

The 50386/A2 DCU multiple communication pathways, expandable to six ports plus the ALERT Radio port, allows for many combinations of communication equipment. The radio telemetry equipment connects through the box by using a BNC connector. Lightning arrestors must be mounted outside of the box

An SMA GPS antenna connector is provided on the top plate with the GPS antenna cable.

The 50386N is intended to be operated on battery power with either solar panel or AC battery chargers. Some applications may specify AC power supplies with battery back-up; also, the battery may be housed external from the NEMA box. The power connections are 3-pin mini bulkhead MS connectors.

2.4.3 Rack Mount

The Rack Mount configuration, 50386/A2-K, fits a 19" rack and is 5U high.

The sensor input connector packages use the MS connector package on the back of the enclosure.

The 50386/A2 DCU multiple communication pathways, expandable to six ports plus the ALERT Radio port, allows for many combinations of communication equipment. The radio telemetry equipment connects through the box by using a BNC connector. Lightning arrestors must be mounted outside of the box

An SMA GPS antenna connector is provided on the top plate with the GPS antenna cable.

The 50386N is intended to be operated on battery power with either solar panel or AC battery chargers. Some applications may specify AC power supplies with battery back-up; also, the battery may be housed external from the NEMA box. The power connections are 3-pin mini bulkhead MS connectors.

2.4.4 Expansion

Expansion configurations will use the standard equipment and connectors as much as possible but customer system requirements will dictate the configuration of these units.

2.5 Installations

The details of the installation vary depending on the configuration; however, there are common procedures which apply for all 50386/A2 DCU's. The overall procedure is: 1) unpack and visual inspection, 2) bench check, 3) initial gauge installation, 4) in situ connections, 5) insitu testing and 6) final gauge installation.

2.5.1 Unpack and Visual Inspection

Refer to Receiving and Unpacking section on inside of front cover for instructions.

2.5.2 Bench Check

A bench check will insure that all the equipment is functional before field installation. This is also a good way to familiarize you with the equipment and connections. Programming changes to the .cfg file can be made at this time. Refer to the Testing, Maintenance & Troubleshooting and the ScadaLynx Toolbox Manual for testing and programming procedures.

2.5.3 Initial Gauge Installation

This includes all physical structures, mechanical and/or electrical hardware required for the site to operate. Follow the procedures in the Basic Gauge and Packaged Gauge Manual's; also, take note of all local codes and regulations.

2.5.4 In Situ Connections

When connecting the 50386/A2 DCU to the antenna, sensors and power there are a few things to note:

Connect the antenna before power is applied to the unit. Never operate the radio transmitter without an antenna or 50 Ohm Dummy Load; it is possible to damage the radio when operated with high reflective power.

Check and double check battery polarity before connecting power cables.

WARNING: Failure to correctly connect the battery can cause extensive DAMAGE to the 50386 Data Collection Unit.

Connect the battery before connecting the solar panel or AC charger. These devices are for battery charging only and can not power the unit during a radio transmission.

Sensors connected to the MS bulkhead connectors have a unique combination of pins and key position; check that the mating connectors match pins and rotation.

Sensors connected to the Screw Terminal connectors should have tinned ends; this will help avoid frayed and broken connections.

2.5.5 In Situ Testing

Follow the procedures outlined in the Maintenance, Testing & Troubleshooting section to insure that the unit is functioning correctly; this includes filling out a Maintenance Report form. Note: the F.C.C. requires that the radio transmitter parameters be tested at the time of installation.

2.5.6 Final Gauge Installation

Final gauge installation includes placing all equipment into it's operational position (assembled and secured), a visual site inspection, and a quick review of the Maintenance Report form for completeness.

3 SOFTWARE

3.1	General Description	38
3.1.1	50386/A2 DCU Software Operations	38
3.1.1.1	Operating System (DOS)	38
3.1.1.2	Application Program (Lynx386.exe)	38
3.1.1.3	Configuration Files (filename.cfg)	38
3.1.2	Console Setup	39
3.2	DOS	39
3.2.1	File Transfer - Send	39
3.2.2	File Transfer - Receive	40
3.3	RUN	40
3.3.1	Monitor	40
3.3.2	Command List	41
3.3.3	Command Key Action	41
3.4	PROGRAM	46

3.1 General Description

The operation of the 50386/A2 DCU is controlled by three software packages: the operating system (*DOS*), the application program (*Lynx386.exe*) and the configuration file (*filename.cfg*) which is programmed with the ScadaLynx ToolBox software.

An operators console is connected to the 50386/A2 DCU to monitor program operations. This manual will assume that the operators console is running Windows HyperTerminal.

3.1.1 50386/A2 DCU Software Operations

The three software packages control different aspects of the 50386/A2 DCU operations.

3.1.1.1 Operating System (*DOS*)

The 50386/A2 DCU is a *DOS* computer; the *DOS* operating system is responsible for the file directory system, it executes commands and it runs executable application programs.

Switch S6 (RUN/DEBUG) determines the boot-up mode of operation. When S6 is set to DEBUG the computer will end the boot-up at the DOS command prompt. With S6 set to RUN the boot-up continues with the execution of the application program listed in the *user.bat* file (*Lynx386.exe*).

File transfers, which including downloading data logged files and uploading program updates, are examples of *DOS* operations. Appendix 5.1 lists common *DOS* commands used in the operation of the 50386/A2 DCU

3.1.1.2 Application Program (*Lynx386.exe*)

In the RUN mode the application program, *Lynx386.exe*, is executed; this program controls the operation of the 50386/A2 DCU based upon parameters contain in a configuration file. The standard configuration file is *Lynx386.cfg*.

3.1.1.3 Configuration Files ("*filename*".*cfg*)

Besides *Lynx386.cfg*, other files containing customized programming are used to control the data collection application program. These files are created using the ScadaLynx Toolbox software program. When a configuration file is sent to the 50386 a *Lynx386.ini* file is created which lists this new configuration file name; this configuration file will then control the operation of the 50386/A2 DCU.

3.1.2 Console Setup

The console is either a portable or desktop computer running Window™. The operator's console is used to monitor or control the 50386/A2 DCU program operations and to program configuration files. We use HyperTerminal to monitor program activity or operate in the DOS mode and ScadaLynx ToolBox to program configuration files.

The 50386 COM ports are DTE (9-pin male, RS-232) connectors; to connect the console us a Null Modem 9F to 9F cable (HydroLynx Systems Model 5071C-50386, drawing AC108151 in Section 5.3). To connect the console to the 7-pin MS bulkhead connector on the can configuration use cable 5071C-50386/A2-4 (see drawing AC108148).

The default communication parameters for the 50386 COM1 port are 38400 baud, no parity, 8 data bits, 1 stop bit, no flow control, and no RTS control.

To set-up HyperTerminal to communicate on your computer's COM1 port with the 50386/A2 DCU; create a new HyperTerminal session to Connect using Direct to COM1, click Configure and then set the HyperTerminal parameters to match the 50386 parameters.

3.2 DOS

It will seldom be required for the user to operate the 50386/A2 DCU in the *DOS*, most often it will be a file transfer operation. The 50386/A2 DCU sends and receives files using the Z-Modem protocol; this is the default HyperTerminal protocol. Note that when you Send from the 50386/A2 DCU you will Receive with the HyperTerminal console and vice versa.

3.2.1 File Transfer - Send

The Send command is used to retrieve data logged files and saved program monitor files.

To Send a file saved in the 50386/A2 DCU memory to the connected console:

- At the DOS command prompt type the Send command: "S" followed by a space then the filename you want to send.
- Select Transfer from the HyperTerminal menu bar.
- Select Receive File... from the pull down menu.

3.2.2 File Transfer - Receive

The Receive command is used to load programs, including *Lynx386.exe* updates, into the 50386/A2 DCU.

To Receive a file into the 50386/A2 DCU memory from the connected console:

- At the DOS command prompt type the Receive Command: "R".
- Select Transfer from the HyperTerminal menu bar.
- Select Send File... from the pull down menu.
- Type the filename to be received by the 50386/A2 DCU; note: include the path if the file is in a directory other than the HyperTerminal default directory; (You can also use the browse key to find the file).
- Push the Send button.

3.3 RUN

The operator's console is used in the RUN mode to monitor 50386/A2 DCU operations and to initiate 50386/A2 DCU commands.

3.3.1 Monitor

When the 50386/A2 DCU is started in the RUN mode a start up message is displayed which includes: the program name and version level, the station ID number and name (the .cfg "*filename*"), the date and time, and the 50386/A2 DCU command prompt:

```
HydroLynx Systems -- ScadaLynx 50386 Version 2.00.00
Filename = Lynx386.cfg
Station ID = #### Station name
Time = 09/14/2015 15:40:00
Press [Enter] to enter command mode, then press h for help
```

Then the 50386 will program the ALERT2 encoder by sending a wakeup, the configuration parameters, and then reading the time.

```
ALERT2 Send wakeup
ALERT2 Send configuration parameters
ALERT2 Read GPS time: 12/31/2010 16:00:05 No GPS lock
Power down at 09/14/2015 15:40:10
Next wakeup at 09/14/2015 15:40:15
```

If no key is pressed, the 50386/A2 DCU will power down in 10 seconds after displaying the power down time and time of the next wake up. On power up it takes 13 minutes for the ALERT2 GPS to get the time sync with the latest leap second adjustment. The 50386 will read the GPS time every 5 seconds after power up until the GPS time is synced and then the following message is displayed:

ALERT2 Read GPS time: 09/14/2015 15:53:00 Locked

To wake up the 50386/A2 DCU press the [Enter] key; the 50386/A2 DCU RUN LED4 will turn on. Press the [Enter] key again to display the 50386/A2 DCU command prompt: ">".

If DCU security is enabled you will be asked to login:

Login:

Enter your login name and press the [Enter] key. You will be prompted for a password:

Password:

Enter the password and press the [Enter] key.

3.3.2 Command List

To display a list of the 50386/A2 DCU commands type "h" at the 50386/A2 DCU command prompt: >h

```
HydroLynx Systems -- ScadaLynx 50386 Version 1.31.00
Filename = Lynx386.cfg
Station ID = ##### Station name
Key help:
a : Read and display points
b : Toggle sensor power state
c : Display/clear reset count
d : Display points
g : Increase diagnostic display level
h : Display help
k : Disconnect console
l : Login/logout
n : Toggle power down state
p : Power down 386
q : Quit program
r : Restore normal operations
s : Send SDI-12 commands
t : Test transmit
v : Calibrate ADC
w : Test watchdog timer
x : Quit program
z : Reboot 386
Esc: Quit program
```

Press [Enter] to continue

You must press [Enter] to let the program continue in its monitor display. The command keys are not case sensitive (d and D will both display points).

3.3.3 Command Key Action

- a: Read all sensor data and display the values.
- b: Toggle sensor power state turns the sensor power on if off or off is on. The Sensor power LED2 will turn on when sensor power is on. Note that sensor power will be turned off if the program powers down the 50386.
- c: Display the Reset count. Press 1 to reset the count:
Reset count=15
Enter 1 to clear count, press [Enter] for no change
- d: Displays the sensor data for the last sample.
- g: Increase the diagnostic display level. (Use command key "r" to reset display level.)
- h: Display the help screen.
- k: Stop display of messages on operator console.
- l: Login or logout from DCU security.
- n: Toggle the power down feature to on if off or off if on.
- p: Force a power down.
- q: Quits the application program and displays the **DOS** command prompt.
- r: Restore the display monitor until the next power down. No command prompt will be displayed until the [Enter] key is pressed again.
- s: Send an SDI-12 command using a script file. A numbered list of script file names will be displayed. Enter the number for the script file matching your SDI-12 sensor. Two scripts are provided by default, GPSSER.SDI is the GPS Time Status script and STANDARD.SDI is the standard script file for SDI-12 sensors.
SDI script file list
1 GPSSER.SDI
2 STANDARD.SDI 2

Type 2 [Enter] to select the standard SDI-12 script file.

The program will display the command provided in the script file. For example:

```
SDI script commands
1 Measure
2 Concurrent
3 Verify
4 Read Identification
5 Read Sensor address
```

- 6 Set Sensor Address
- 7 Enter Sensor Address
- 8 Enter Command
- Enter SDI script command number

Enter the number of the command to execute. Some commands may require additional input from you for a command parameter. For example, command 6, Set Sensor Address, lets you change the sensor address and command 6, Enter Command, lets you enter any SDI-12 command (do not include the address or trailing ! sign for the command). The SDI-12 commands sent and responses received are displayed (e.g.): "1" (Measure)

```
SDI-12 Send with Break: 0M!
SDI-12 Read: 00152
SDI-12 Wait 015 seconds for 2 readings
SDI-12 Read: 0
SDI-12 Send: 0D0!
SDI-12 Read: 0+.0340+26.0
SDI-12 Readings: +.0340+26.0
```

Press [Enter] alone to quit the SDI-12 command.

- t: Test the transmitter.
- Test state: OFF
 - Enter test number:
 - 0 = Toggle test state
 - 1 = Test battery
 - 2 = Transmit data
 - 3 = Transmit tone
 - 4 = Transmit no tone
 - 5 = Read analog input
 - 6 = Baseset an input
 - 7 = Set raw data
 - 8 = Set scaled data
 - 9 = Test GOES transmitter
 - A = Test ALERT2 transmitter

Enter the test number, 1 – 9 or A

Test 1 measure and displays the battery voltage under load.

Test 2 measures the sensor data and transmits the data reports on the selected transmit port in normal or alarm data format:

- Select a comport test number:
- 1 = ALERT1 normal data
- 2 = ALERT1 alarm data
- 3 = ALERT2 normal data
- 4 = ALERT2 alarm data

Test 3 transmits a dual, high, or low tone for 5 seconds on the selected transmit port:

Select a comport test number:

- 1 = ALERT1 dual tones
- 2 = ALERT1 high tone
- 3 = ALERT1 low tone
- 4 = ALERT2

Test 4 transmits with no tone on the selected transmit port:

Select a comport test number:

- 1 = ALERT1
- 2 = ALERT2

Test 5 reads the selected analog input and displays the reading in 0 - 5 Vdc:

Enter the analog channel number: 1 - 16

8

Enter the input range (1=5Vdc, 2=1Vdc, 3=100mV, 4=55mV, 5=25mV):

1

Start analog input 8 test

Test analog input is 4.8487 volts

Test 6 will baseset a sensor to a value entered. The program will take a reading and compute the point calibration adder to match the value entered. First a list of points is printed. Enter the point number to baseset:

- 1 1004 Rainfall
- 2 1005 Water Level

Enter the point number: 1 - 2

2

Enter the point reading:

2.56

Taking point reading...

1005 Water Level Raw=0 Cal=2.56 feet

Baseset computed.

1005 Water Level Raw=0 Cal=2.56 feet

Test 7 will set the raw value of a point. First a list of points is printed. Enter the point number to set:

- 1 1004 Rainfall
- 2 1005 Water Level

Enter the point number: 1 - 2

1

Enter the point raw data value:

25

1004 Rainfall Raw=25 Cal=25 millimeters

Test 8 will set the scaled value of a point. First a list of points is printed. Enter the point number to set:

- 1 1004 Rainfall
- 2 1005 Water Level

Enter the point number: 1 - 2

2

Enter the point scaled data value:

1.85

1005 Water Level Raw=185 Cal=1.85 feet

Test 9 will test a GOES transmitter. A test menu is displayed:

Enter transmitter test number:

- 1 = Read Configuration
- 2 = Write Configuration
- 3 = Display Buffered Data
- 4 = Clear Buffered Data
- 5 = Test Transmit No Tone
- 6 = Reset Transmitter
- 7 = Start Self Test
- 8 = Read Test Results

Test A will test an ALERT2 transmitter. A test menu is displayed:

Enter transmitter test number:

- 1 = Read Configuration
- 2 = Write Configuration
- 3 = Read GPS time
- 4 = Test Transmit Tone

v: Calibrate ADC

ADC Calibration

The current ADC offset and gain are:

Offset: 005804

Gain : 6581bd

Enter the ADC channel number for offset calibration (1-16, ESC=quit)

Enter the analog input that will be jumped to ground for the offset calibration: "1"

Enter the ADC channel number for gain calibration (1-16, ESC=quit)

Enter the analog input that will be used for voltage input for the gain calibration: "8"

Enter the input range (1=5Vdc, 2=1Vdc, 3=100mV, 4=55mV, 5=25mV):

Enter the voltage input range number: "1"

Jump analog input to ground.

Press [Enter] to start the system offset calibration.

Press [Esc] to skip system offset calibration.

Apply the calibrating voltage.

Enter the calibrating voltage (e.g. 4.862 or Esc=quit).

Enter the measured voltage on analog 8 (Vref).

Press [Enter] to start the system gain calibration.

Press [Esc] to skip system gain calibration.

The new ADC offset and gain are:

Offset: 005804

Gain : 6581bd

- w: Test the watchdog timer.
 - Starting watchdog test
 - PCOS will do a soft reboot in 15 seconds
 - Press W to force a hard reboot in 30 seconds
 - Press any other key to key to quit test
- x: Quits the application program and displays the **DOS** command prompt.
- z: Reboots the 50386/A2 DCU; this is a software reboot. To clear all hardware latches perform a power up reboot.
- Esc: Quits the application program and displays the **DOS** command prompt.

3.4 PROGRAM - ScadaLynx Toolbox

When the operator's console is running the ScadaLynx ToolBox, .cfg files can be created and saved; also, these files can be sent to a connected 50386/A2 DCU.

The ScadaLynx Toolbox includes Program Monitor and Data Logging menus. Files created under the commands of these menus can be saved on the 50386/A2 DCU and received by the connected console.

The complete functions are described in the ScadaLynx ToolBox Manual document number AC102712.

4 MAINTENANCE, TESTING and TROUBLESHOOTING

4.1	Maintenance	48
4.1.1	Routine Maintenance	48
4.1.2	Maintenance Report	48
4.2	Testing	49
4.2.1	Power-up/Reset Test: LED Sequence	49
4.2.1.1	Power-up/Reset Test: 50386 SLB LED	49
4.2.1.2	Power-up/Reset Test: ALERT2 Encoder LED	49
4.2.2	Level 1 Test: Test Switch	49
4.2.2.1	Power-up/Reset Test: 50386 SLB LED	50
4.2.2.2	Power-up/Reset Test: ALERT2 Encoder LED	50
4.2.3	Level 2 Test: Program Monitor	50
4.2.4	Level 3 Test: ToolBox Data & Test Tabs	50
4.2.5	Receiver Test	50
4.2.5.1	RX Audio Out: P5 pin 1	51
4.2.5.2	Carrier Detect (CD): P5 pin 7	51
4.2.5.3	RF Receive Antenna	51
4.2.6	Decoder Test	51
4.2.7	Repeater Test	51
4.2.7.1	Repeater Wait Timer	52
4.2.7.2	Talkback Wait Timer	52
4.2.7.3	Receive On During Transmit	52
4.2.7.4	Repeat ID Range Table	52
4.3	Troubleshooting	53
4.3.1	The Usual Suspects: Common Failures	53
4.3.1.1	Power Failures	53
4.3.1.2	Transmission Failures	53
4.3.1.3	Sensor Failures	53
4.3.2	Troubleshooting with the Console	54

4.1 Maintenance

The 50386/A2 DCU is designed to operate at a remote location with minimal maintenance requirements. HydroLynx Systems recommends twice-a-year site visits to perform routine maintenance. Some sites will require more frequent visits due to local conditions or sensor types; refer to the station or sensor manual for maintenance recommendations.

HydroLynx Systems also recommends keeping a record describing any site visit; an example of a Maintenance Report form can be found in Section 5.3 Drawings: Document number WP104973. Our customers have found the information recorded on these forms useful in tracking equipment performance and location, and keeping aware of future maintenance requirements.

4.1.1 Routine Maintenance

A visual inspection which checks for any signs of physical damage to connectors, cable and wires, sensors, antenna, the 50386/A2 DCU, any support structure or the site itself is one of the best ways to avoid a future failure. Cable and connectors are the number one cause of failures.

Battery usage has changed over the years from the ALERT Cyclic Use to more of a Standby Use as more users rely on solar panels to maintain battery charge. Refer to the Model 5031-“XX” Gel Cell Battery Manual, Document # AC102851, for battery tests and maintenance recommendations.

Replace the moisture absorbent silica gel packet with a freshly charged packet once a year. Old packets may be recharged by heating them to 250 °F for 16 hours or you may purchase new desiccant packs from HydroLynx Systems.

Fill out Maintenance Report.

4.1.2 Maintenance Report

The Maintenance Report includes sections to record station information and the results of tests outlined in the Basic Gauge Manual, Document# AC102791. The test include Power: battery and solar panel, Signal Out: radio transmitter forward and reflected power, frequency error and deviation, and Signal In: compares sensor input to sensor data.

The 50386/A2 DCU's configurations include receiver, decoder and repeater functions, those test are outlined in the next section 4.2 Testing; include the results of these tests on the Maintenance Report.

4.2 Testing

As mentioned above in section 4.1.2 Maintenance Report, the Basic Gauge Manual outlines the tests to perform on the 50386/A2 DCU when operating as a data transmitter. The Level 2 and Level 3 tests contain functions that will assist in performing these tests.

The following tests will verify 50386/A2 DCU functionality. Some of these tests will cause a radio data report. Insure that an antenna or dummy load is connected before starting the test to prevent damage to the transmitter. To prevent test data from being transmitted to the central site computer replace the antenna with a 50 Ohm dummy load.

WARNING: Transmitting without an antenna or dummy load can damage the radio.

4.2.1 Power-up/Reset Test: LED Sequence

4.2.1.1 Power-up/Reset Test: 50386 SLB LED

During reset the LEDs on the PCOS will be light in sequence; note: LED1 is red, LED 2 is green. The completion of this sequence indicates that the 50386/A2 DCU is in RUN mode:

- Both LEDs flash twice then remain on
- LED2 goes off in 5 seconds (SLB LED5 TEST flashes)
- LED1 goes off 10 seconds later (SLB LED4 RUN is connected to LED1)
- LED1 (SLB LED4 RUN) blinks every 5 seconds until GPS time is synced.
- LED1 (SLB LED4 RUN) blinks every 15 seconds after GPS time is synced.

4.2.1.2 Power-up/Reset Test: ALERT2 Encoder LED

During reset the LEDs on the ALERT2 encoder will be light in sequence. The completion of this sequence indicates that the 50386/A2 GPS is time synced:

- D7 Radio On flashes green.
- D3 GPS On flashes red.
- D7 Radio On flashes green every 30 seconds.
- After 1 minute, D3 GPS On turns red and stays on until GPS time is synced.
- After 13 minutes, D3 GPS On turns off, D6 GPS LK turns green and stays on.

4.2.2 Level 1 Test: Test Switch

The Level 1 test reads and transmits all active sensor data values.

To initiate a Level 1 test when the 50386/A2 DCU is awake, press the **TEST** switch: S8.

To wake the 50386/A2 DCU from power-down state, press and hold the test switch for up to 15 seconds. On the watch dog wake up, the test will be started.

When the console is connected to the 50386/A2 DCU the results of the Level 1 test will be displayed.

4.2.2.1 Power-up/Reset Test: 50386 SLB LED

- SLB LED4 Run turns on if was off.
- SLB LED5 Test turns on.
- SLB LED3 Sensor power turns on to read sensors then turns off.
- SLB LED5 Test blinks while in test mode.
- Test mode is disabled after pressing the **TEST** switch again or after 1 hour by default. Test mode reset interval is programmable in .cfg.
- SLB LED5 Test turns off when test mode is disabled.

4.2.2.2 Power-up/Reset Test: ALERT2 Encoder LED

- D6 GPS LK is green for GPS lock.
 - D5 SERIAL 0 turns green on to indicate data is buffered.
- At TDMA transmit time:
 - D5 SERIAL 0 turns off
 - D7 Radio On turns green to power up radio
 - D4 Radio TX turns red to transmit
- When transmit is done
 - D7 Radio TX turns off.
 - D5 Radio On turns off.
- D6 GPS LK stays green for GPS lock.

4.2.3 Level 2 Test: Program Monitor

The 50386/A2 DCU includes commands that can be accessed through the console by entering a command key at the 50386/A2 DCU command prompt. These commands allow the user to test 50386/A2 DCU functions and operations while viewing the results. To view the command list type "h" at the 50386/A2 DCU command prompt, e.g. > **h** (refer to sections 3.3.2 Command List and 3.3.3 Command Key Action).

4.2.4 Level 3 Test: ScadaLynx ToolBox Data and Test Tabs

The ScadaLynx ToolBox has two tabs, Data and Test, which are used to test and view 50386/A2 DCU functions and operation. Refer to ScadaLynx ToolBox Manual (WD102712).

4.2.5 Receiver Test

The 50386R or the receive section of the repeater have three parameters that can be tested in the field: RX Audio Out, tone amplitude; Carrier Detect, squelch; and RF Receive

Antenna, reflected power.

Note: adjustments to the radio itself should only be made by trained radio service personnel.

4.2.5.1 RX Audio Out: P5 pin 1

To test RX Audio Out an RF signal must be transmitted with the correct frequency and deviation. Measured the tone amplitude at P5 pin 1 with an oscilloscope, (or an AC volt meter; to convert the AC_{RMS} voltage to V_{pp} : $AC_{RMS} \times 2.829 = V_{pp}$). The minimum tone amplitude is 800 mV_{pp}.

4.2.5.2 Carrier Detect (CD): P5 pin 7

The CD signal is an active LO (0Vdc) when the radio is receiving carrier; otherwise, the line is HI (5Vdc). The squelch is set to 12 dB SINAD $\leq 0.5 \mu V$ (-113 dBm). To accurately make this measurement requires a radio service monitor and a SINAD meter. However, the field technician can measure P5 pin 7 with a DC volt meter and make a PASS/FAIL test. When a RF signal is transmitted to the receiver this line should go LO; otherwise, this line is HI.

4.2.5.3 RF Receive Antenna

The receive antenna is tested for reflected power as if it were a transmit antenna.

- Attach a watt meter and transmitter to the antenna cable.
- Select the proper slug for reverse power and frequency.
- Initiate a transmission. The duration of the transmission must be long enough to obtain a stable reading on the watt meter.
- Compare the measured reading to the transmitter's forward power.
- Limit: 20 : 1 power ratio; Forward : Reflected.

4.2.6 Decoder Test

The 50386D output is an RS232 signal on COM2 pin 3 (TXD). Note that RS232 signal levels vary from $\pm 3 V$ to $\pm 12 V$.

- Attach an oscilloscope to COM2; pin 3 (TXD) and pin 7 (GND).
- Verify that the standby voltage (no transmission) is the negative voltage level.
- Initiate a transmission to the receiver.
- Verify that the signal changes between the negative and positive voltage levels.

4.2.7 Repeater Test

The RF portions of the repeater are checked as previously described for separate receive and transmit units; note that a received signal may initiate a transmission so insure that an antenna or dummy load is attached to the transmit antenna port.

The 50386RP has features that allow the unit to function as a Store & Forward or a Straight Thru repeater. These features include the Repeater Wait and Talkback Wait timers, Receiver On During Transmit, and Repeat ID Range Table. To test these functions a RF signal must be transmitted to the repeater.

4.2.7.1 Repeater Wait Timer

This function is used when two repeaters are used in the system which may here the same remote site transmissions. One repeater transmissions are delayed to allow the other repeater to complete its transmissions; this will keep the repeaters from interfering with each other.

- Initiate data transmission to repeater.
- Verify the repeat data transmission is delayed by time programmed into Repeater Wait parameter.

4.2.7.2 Talkback Wait Timer

This function keeps the repeater from repeating the same data report over within the time programmed in the Talkback Wait parameter. This will stop repeaters that can here each other from looping data reports back and forth.

- Initiate first data transmission to repeater.
- Initiate second, identical data transmission to repeater within time programmed into Talkback Wait parameter.
- Verify that the second data transmission is not repeated. Note that the first repeated data transmission must be completed before the second, identical data transmission is initiated.

4.2.7.3 Receive On During Transmit

This function allows the 50386RP to function as a straight Thru Repeater. Note that this type of repeater could have a 100% duty cycle on the transmitter if it receives in a high traffic area. This is not allowed with the ALERT specification and a hardware timer will turn the power to the transmitter off after 10 seconds of continuous power. Also note that there are RF issues which must be considered for this type of operation.

- Initiate first data transmission to the repeater
- Initiate second data transmission to the repeater while the repeater is repeating the first data transmission.
- Verify that both data transmissions are repeated.

4.2.7.4 Repeat ID Range Table

The Repeat ID Range Table allows the repeater to pass a range of ID. This is very important in congested areas with multiple repeater paths; restricting certain IDs from repeating on certain paths lessens the loads on those radio paths.

- Initiate data transmission with ID number within the repeat range.
- Verify data transmission is repeated.
- Initiate data transmission with ID number outside repeat range.
- Verify data transmission is not repeated.

4.3 Troubleshooting

The goal of troubleshooting is to find and repair the cause of a failure in order to return a site to normal operation; troubleshooting is an on-site activity. On-site repairs are most often accomplished by replacing the failed unit; e.g. sensor, antenna, DCU etc.

The general troubleshooting procedure is to check Power, Signal-out and Signal-in. The test procedure outlined in the Basic Gauge Manual follows along this line checking the battery and solar panel, the radio output, and the sensor inputs. The tests in Section 4.2 Testing are also useful during the troubleshooting process to determine the cause of failure. For more information or help with troubleshooting you can contact a HydroLynx Customer Service Representative at (916) 384-1800.

4.3.1 The Usual Suspects: Common Failures

The most common causes of failures include cable and connectors, battery, transmission line and damage to sensors. Many failures will have physical signs of damage so a visual site inspection is one of the most important tools of troubleshooting.

4.3.1.1 Power Failure

Power-up/Reset Test determines if board is operating.

Battery failures include: a weak or discharged battery up to a battery that can not hold a charge or is damaged. The most important test to determine a battery's functionality is the battery voltage under load Test.

Solar panel tests check charging ability.

4.3.1.2 Transmission Failures

Connect a wattmeter and a dummy load to the antenna connector on the transmitter. Check the output and reflected power. If the problem is in the cables or connectors, replace or repair them. If the 50386 still does not transmit, use a radio receiver tuned to the transmit frequency to listen for the two tone signal when you key the transmitter.

4.3.1.3 Sensor Failures

Check the sensor input with a spare sensor or a sensor test plug. Check sensor operation with sensor test fixture.

4.3.2 Troubleshooting with the Console

Through the use of a portable or a lap-top personal computer it is possible to check both the system parameters and the sensor parameters of the 50386 Data Collection Unit. If a programming error is causing the 50386 to fail this can be fixed in the field by reprogramming the 50386 option or the sensor input parameters.

5 APPENDIX

5.1	DOS Commands	56
5.2	.cfg set up examples	57
5.3	Drawings	58

5.1 DOS Commands

This list contains the most commonly used DOS commands.

Command	Description
DATE	Displays the date from the system internal calendar. Allows revision.
DEL	DELeTe. Deletes specified files.
DIR	DIRectory. Lists contents of a specified directory.
HELP	Lists all available ROM-DOS commands along with brief descriptions.
REN	REName. Renames files.
TIME	Displays current time from system internal clock. Allows revision.
TYPE	Displays the contents of a test file on the monitor.
VER	Displays current version of ROM-DOS on the monitor.
R	Receives a file from the PCOS . Use HyperTerminal file transfer function.
S	Sends a file to the PCOS . Use HyperTerminal file transfer function.
SYSCFG /CNBD=	Used to change com port baud rate.

5.2 .cfg File Set-up Examples

The .cfg files listed here give example configurations for a few representative sensor and repeater packages. The example .cfg files are included with the ScadaLynx Toolbox CD for your convenience.

An ALERT2 concentrator receives ALERT1 and repeats ALERT2. An ALERT2 repeater receives ALERT1 and ALERT2 and repeats ALERT2.

filename.cfg	Description
53RP8SA2.cfg	ALERT2 Concentrator Weather Station SDI-12
53RP9SA2.cfg	ALERT2 Concentrator Level Station SDI-12
53RP54A2.cfg	ALERT2 Concentrator Rain Station
53RP81A2.cfg	ALERT2 Concentrator Weather Station
53RP90A2.cfg	ALERT2 Concentrator Level Station
53RPA2.cfg	ALERT2 Concentrator no sensors
538SA2.cfg	ALERT2 Weather Station SDI-12 level
539SA2.cfg	ALERT2 SDI-12 Level Station
539SSDI.cfg	ALERT1 Level Station SDI-12
5052RP.cfg	ALERT2 Repeater no sensors
5052RP8S.cfg	ALERT2 Repeater Weather Station SDI-12
5052RP9S.cfg	ALERT2 Repeater Level Station SDI-12
5052RP54.cfg	ALERT2 Repeater Rain Station
5052RP81.cfg	ALERT2 Repeater Weather Station
5052RP90.cfg	ALERT2 Repeater Level Station
5354.cfg	ALERT1 Rainfall station
5354A2.cfg	ALERT2 Rainfall station
5381.cfg	ALERT1 Weather Station raw units
5381A2.cfg	ALERT2 Weather Station Analog Level
5381A2GL	ALERT2 Weather Station with GILL ultrasonic wind sensor
5381GILL	ALERT1 Weather Station with GILL ultrasonic wind sensor
5381GOES.cfg	GOES Weather Station
5381PK.cfg	ALERT1 Weather Station scaled units
5381US.cfg	ALERT1 Weather Station ultrasonic wind sensor
5390.cfg	ALERT1 Level Station Analog
5390A2.cfg	ALERT2 Level Station Analog
5390GOES.cfg	ALERT1/GOES Level Station SDI-12
5390ORB.cfg	Orbcomm Radio Example
5390RDA2.cfg	ALERT2 Wireless Link Radar level sensor
5390RDWL.cfg	ALERT1 Wireless Link Radar level sensor
5390SDI.cfg	ALERT1 SDI-12 level sensor station
5390WL.cfg	ALERT1 Level Station Wireless Link
5390WLA2.cfg	ALERT2 Level Station Wireless Link
5391.cfg	ALERT1 Water Quality Station
5391A2.cfg	ALERT2 Water Quality Station
50386D.cfg	ALERT1 Decoder
50386D-M.cfg	ALERT1 Decoder with Modbus communication
50386N.cfg	ALERT1 NEMA Enclosure with standard input connector package

50386NA2.cfg	ALERT2 NEMA Enclosure with standard input connector package
50386NZ.cfg	ALERT1 NEMA Enclosure with full input connector package
50386RD.cfg	ALERT1 Repeater and Decoder
Lynx386.cfg	ALERT1 Default configuration
S&F_RP9S.cfg	ALERT1 Repeater Level Station Wireless SDI-12
S&F_RP54.cfg	ALERT1 Repeater Rain Station
S&F_RP81.cfg	ALERT1 Repeater Weather Station
S&F_RP90.cfg	ALERT1 Repeater Level Station
S&F_RPT2.cfg	ALERT1 Repeater - 2 antennas
S&F_RPTR.cfg	ALERT1 Repeater - 1 antenna

5.3 Drawings

The following drawings are enclosed to assist with installation, maintenance, testing and trouble-shooting.

Drawing# Description

AC108252	Top Plate Interconnect PCB, Schematic.
AC108253	Top Plate Pin Out, Outline
AC108180	Screw Terminal Strip PCB, Schematic.
VS108223	Typical Sensors to 50386N, Wiring Diagram.
AC108149	SDI-12 Connector, Wiring Diagram.
AC108410	SDI-12 Screw Terminal Strip, Wiring Diagram.
VS108150	SDI-12 Sensor Cable, Wiring Diagram
VS108435	SDI-12 Sensor Cable with Desiccant Box, Wiring Diagram
AC108151	Console Cable, 9 to 9 pin, Wiring Diagram
AC108148	Console Cable, 7 to 9 pin, Wiring Diagram
WP108116	50386 Board Layout
WP104973	Maintenance Report Form
WD100898	Test Results Report
AC107484	ALERT / IFLOWS Transmission Formats

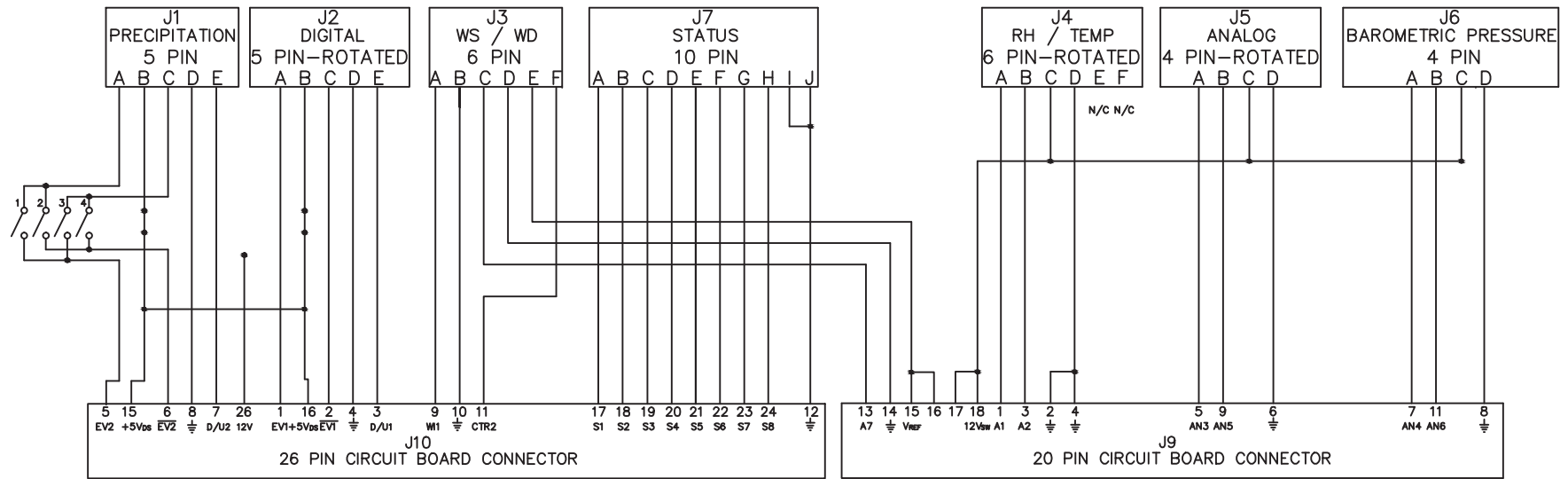

N/A		REDRAWN ON NEW BORDER		07/25/00
ECN#		DESCRIPTION		DATE
UNLESS OTHERWISE SPECIFIED: DIMENSIONS ARE IN INCHES TOLERANCES		MODEL USAGE		
FRACTIONS = ±				
.XX = ±		MODEL NO. 50386		
.XXX = ±		TITLE PCB, INTERCONNECT		
MAP'L				
FINISH		DRAWN BY S.MALONEY		DATE 3-14-04
TREATMENT		CHECKED BY		DATE
		DWG TYPE SCHEMATIC		REV A
		SIZE B	DWG NO. AC108252	



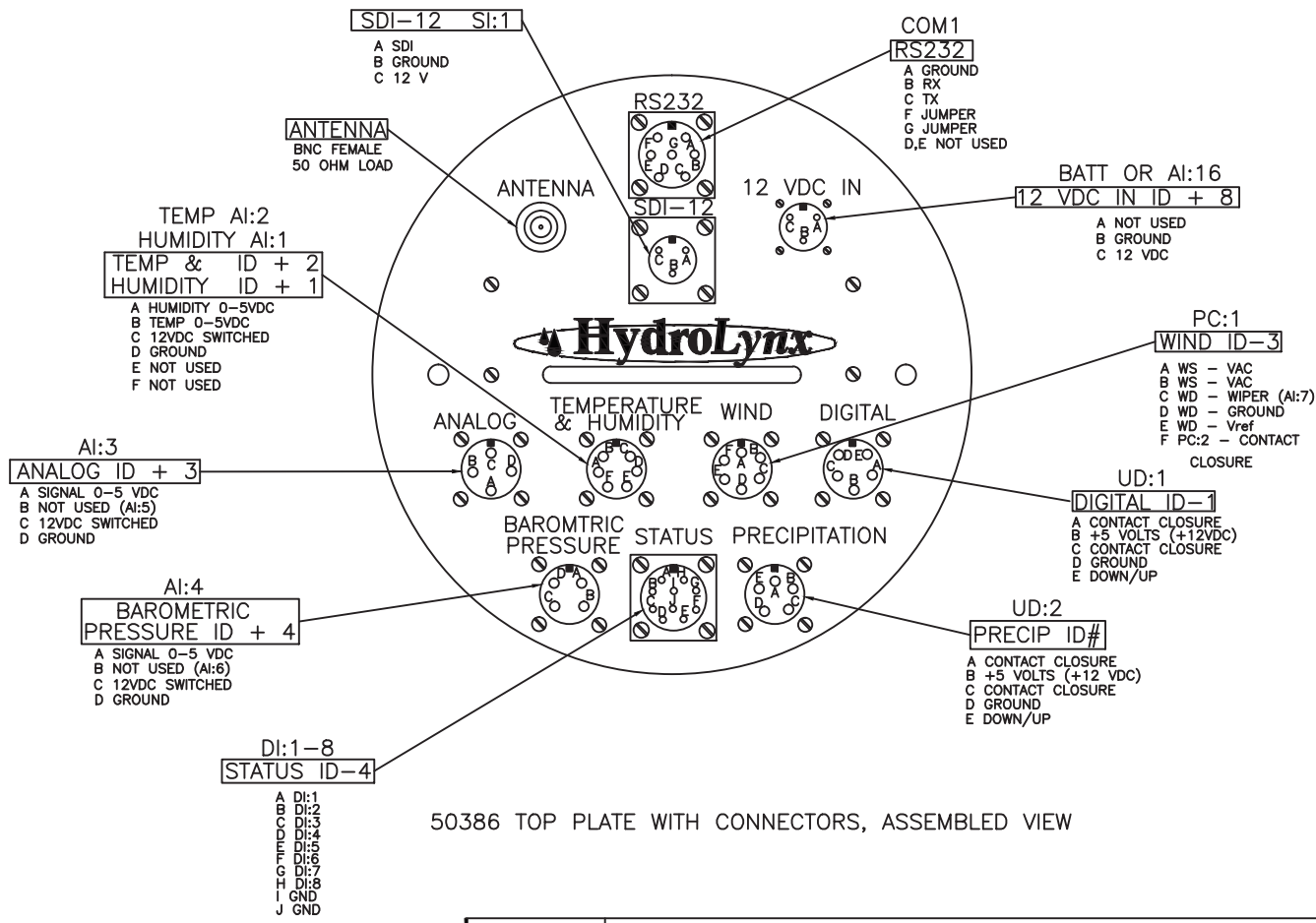

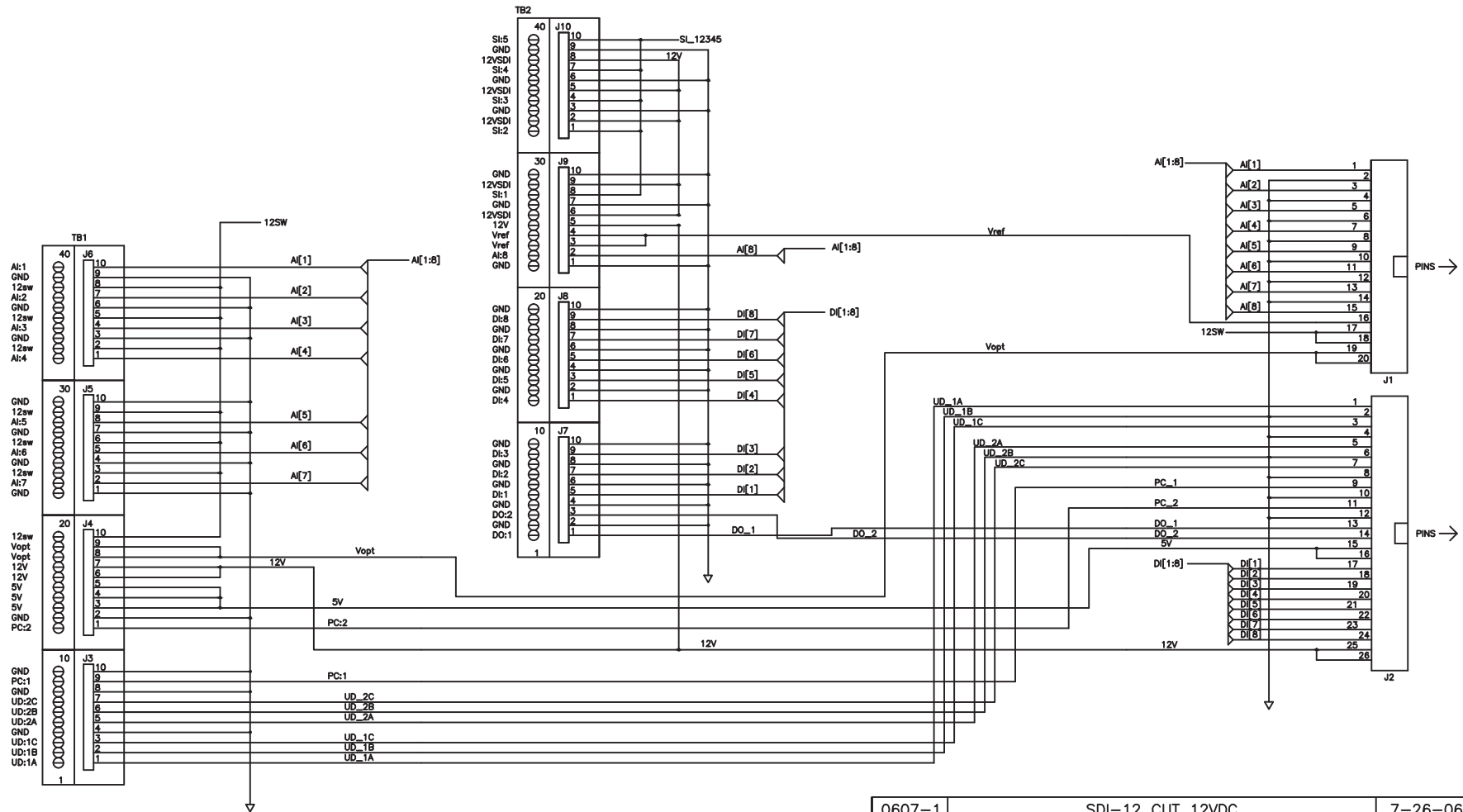

50386 TOP PLATE WITH CONNECTORS, ASSEMBLED VIEW

ECN#	DESCRIPTION	DATE
	MODEL USAGE	
	MODEL NO.	50386
	TITLE	PIN OUTS FOR INTERCONNECT CIRCUIT BOARD
DRAWN BY S.MALONEY	DATE 3-14-04	DWG TYPE OUTLINE
CHECKED BY	DATE	SIZE A
	DWG NO. AC108253	REV A

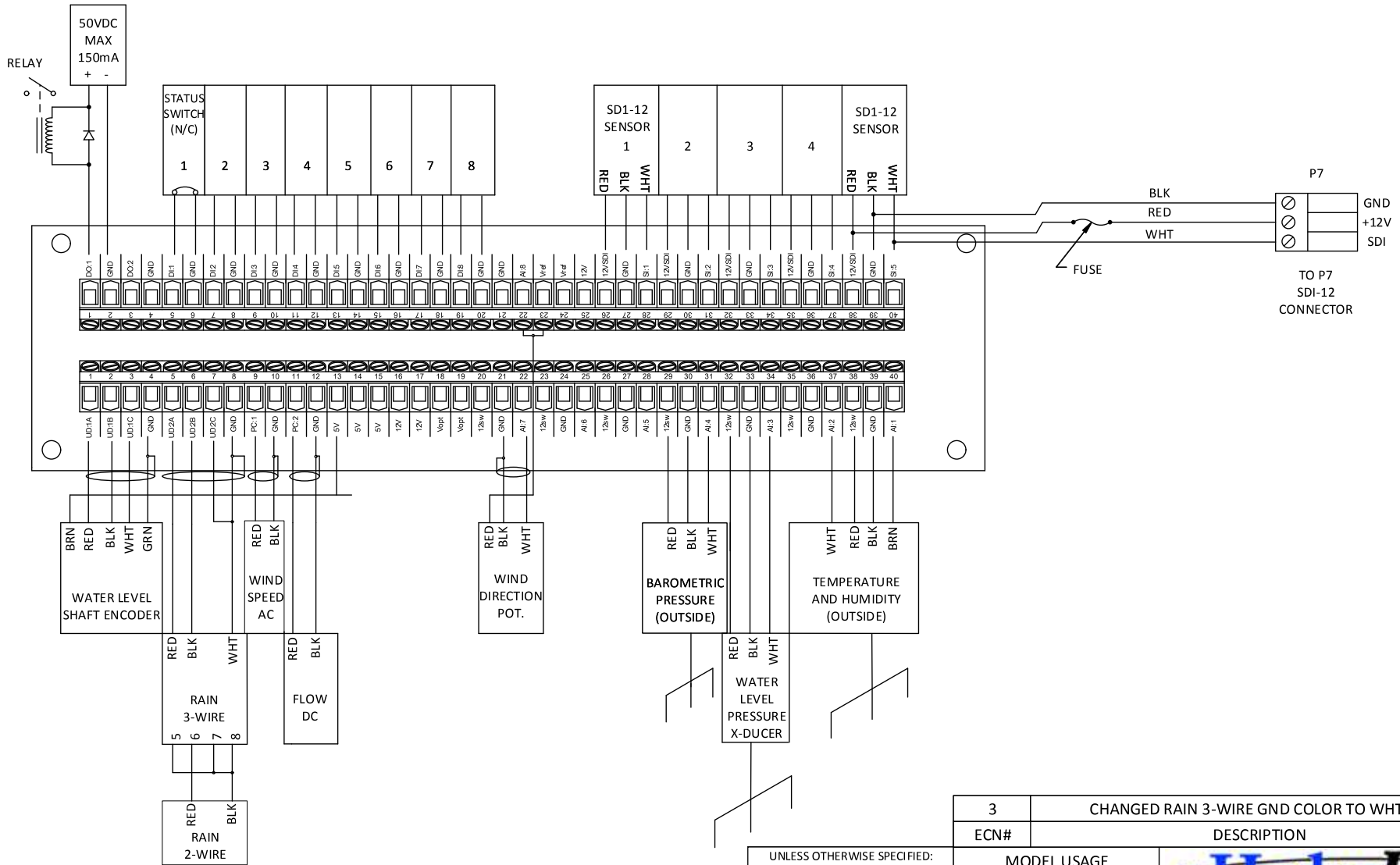

0607-1	SDI-12 CUT 12VDC	7-26-06
ECN#	DESCRIPTION	DATE
MODEL USAGE		
50386-ST5		
	MODEL NO.	50386-ST5
	TITLE	PCB, SCREW TERMINAL STRIP
DRAWN BY M.MALONEY	DATE 3/19/04	DWG TYPE SCHEMATIC
CHECKED BY	DATE	SIZE B DWG NO. AC108180 REV A



3	CHANGED RAIN 3-WIRE GND COLOR TO WHT	8/24/17	
ECN#	DESCRIPTION	DATE	
MODEL USAGE			
UNLESS OTHERWISE SPECIFIED: DIMENSIONS ARE IN INCHES TOLERANCES			
FRACTIONS = ±			
.XX = ±		MODEL NO. 50386N	
.XXX = ±		TITLE TYPICAL SENSORS	
MAT'L			
FINISH	DRAWN BY M. Maloney	DATE 3/19/04	DWG TYPE WIRING DIAGRAM
TREATMENT	CHECKED BY David C. Leader	DATE 8/24/17	SIZE B DWG NO. VS108223 REV 3

REAR VIEW
3-PIN MS BULKHEAD
MALE CONNECTOR
PN: 3102A14S7P

3-PIN MINIATURE PLUGGABLE
TERMINAL WITH SCREW CONNECTION
92F3973(NETWORK)

INLINE FUSE HOLDER
1 AMP FUSE

50386 PCB P7

PIN	CLR	SIGNAL
A	WHT	DATA
B	BLK	GND
C	RED	12VDC

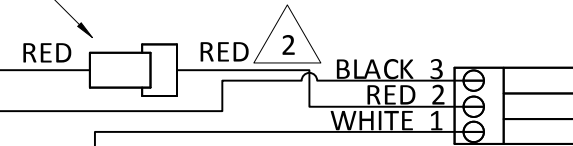
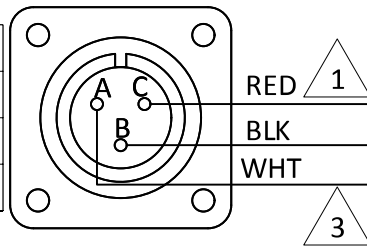

PIN	CLR	SIGNAL
1	WHT	DATA
2	RED	12VDC
3	BLK	GND

WIRE IS 22 AWG, LENGTHS IN INCHES

MODEL	NOTE 1	NOTE 2	NOTE 3
50386	5"	14"	9"
50386RP/A2	5"	14"	9"
50386RP/A2-2	5"	14"	9"
5052RP	4"	8"	10"
5052RP-H	5"	14"	9"

- 1 RED WIRE LENGTH IS FROM 3-PIN MS BULKHEAD MALE CONNECTOR TO IN-LINE FUSE HOLDER.
- 2 RED WIRE LENGTH IS FROM 3-PIN MINIATURE PLUGGABLE TERMINAL (50386 PCB SDI) TO IN-LINE FUSE HOLDER.
- 3 BLK AND WHT WIRE LENGTHS ARE FROM 3-PIN MS BULKHEAD MALE CONNECTOR TO 3-PIN MINIATURE PLUGGABLE TERMINAL.

6	ADDED MODEL 5052RP-H	11/6/2018
5	ADDED 50386RP/A2/LENGTH TABLE/NOTES	11/6/2017
4	CHANGED 5052RP WIRE LENGTH/COLOR DESCRIPTION	6/24/2016
3	CHANGE WIRE LENGTH FOR MODEL USAGE	4/15
2	PART CHANGE FOR FUSE HOLDER, WIRE IS 22 AWG	7/14
ECN#	DESCRIPTION	DATE

UNLESS OTHERWISE SPECIFIED: DIMENSIONS ARE IN INCHES TOLERANCES	MODEL USAGE		
	50386		
	5052RP, -H		
	50386RP/A2		
FRACTIONS = ±	50386RP/A2-2		MODEL NO. 50386, 50386RP/A2, 50386RP/A2-2, 5052RP, -H
.XX = ±	50386RP/A2-2		TITLE HARNESS, SDI-12
.XXX = ±			
MAT'L			
FINISH	DRAWN BY J. BLACKMORE	DATE 8/15/01	DWG TYPE WIRING DIAGRAM
TREATMENT	CHECKED BY A. HERBERT	DATE 11/6/18	SIZE A DWG NO. VS108149 REV 6

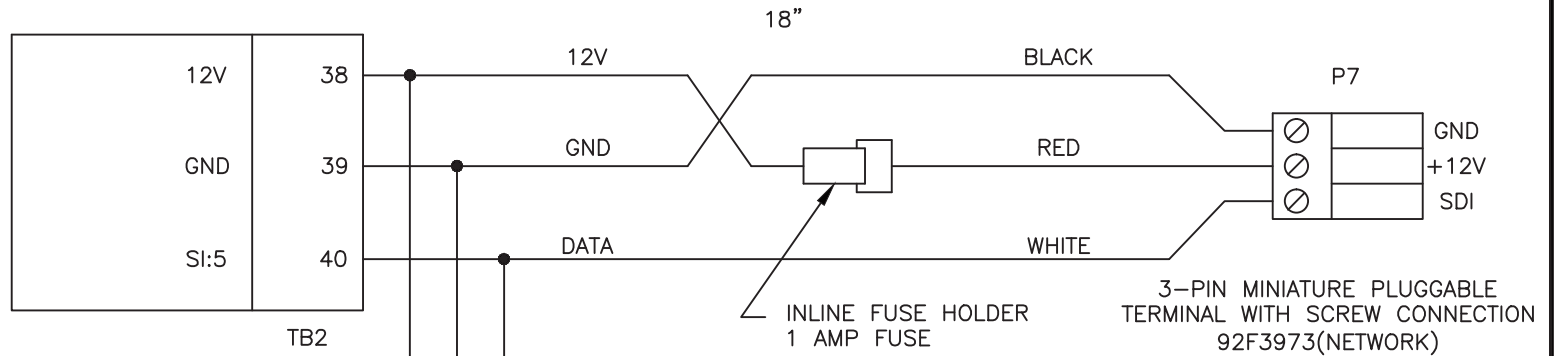

ECN#	DESCRIPTION	DATE
	MODEL USAGE	
	MODEL NO.	50386N, 50386NZ
	TITLE	CHASSIS, SDI12 P7 TO TB2
DRAWN BY M.MALONEY	DATE 8/06	DWG TYPE WIRING DIAGRAM
CHECKED BY	DATE	SIZE A
		DWG NO. AC108410
		REV A

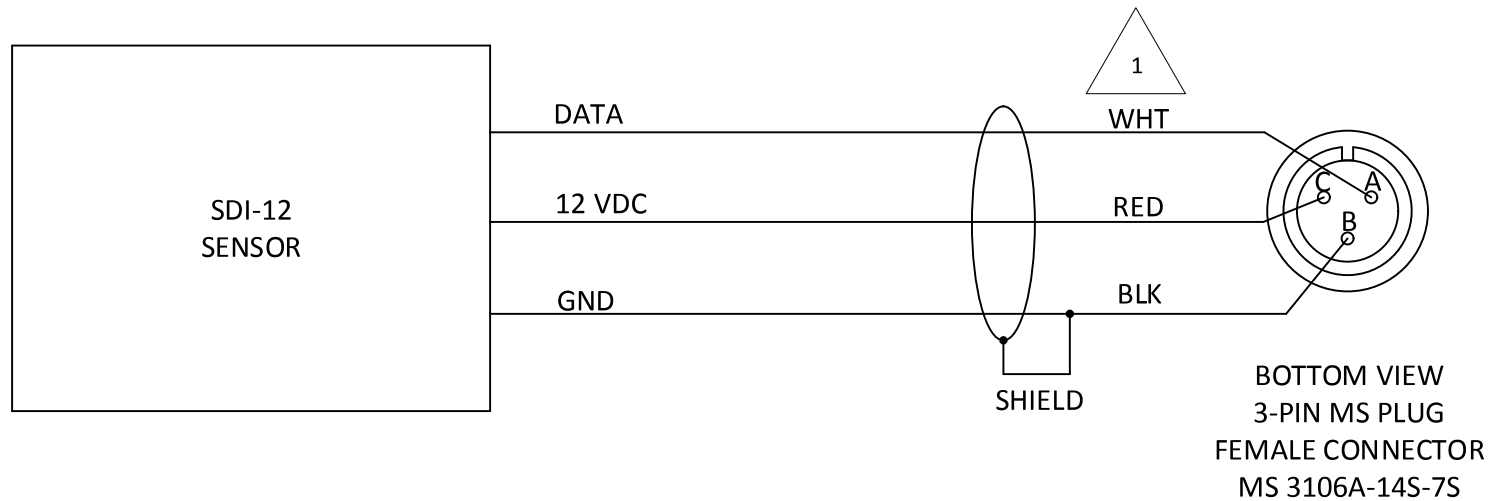

NOTES:

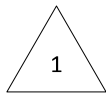



SDI DATA WIRE COLOR IS USUALLY WHT, BUT MAY BE A DIFFERENT COLOR. REFER TO SENSOR MANUAL FOR SENSOR CABLE WIRE COLORS.

E.G. THE SR50AT SONIC RANGING SENSOR W/TEMPERATURE SDI DATA WIRE IS GRN.

2	ADDED WIRE COLORS AND NOTES	8/1/17
1	CORRECTED PLUG MODEL NUMBER	6/19/17
ECN#	DESCRIPTION	DATE

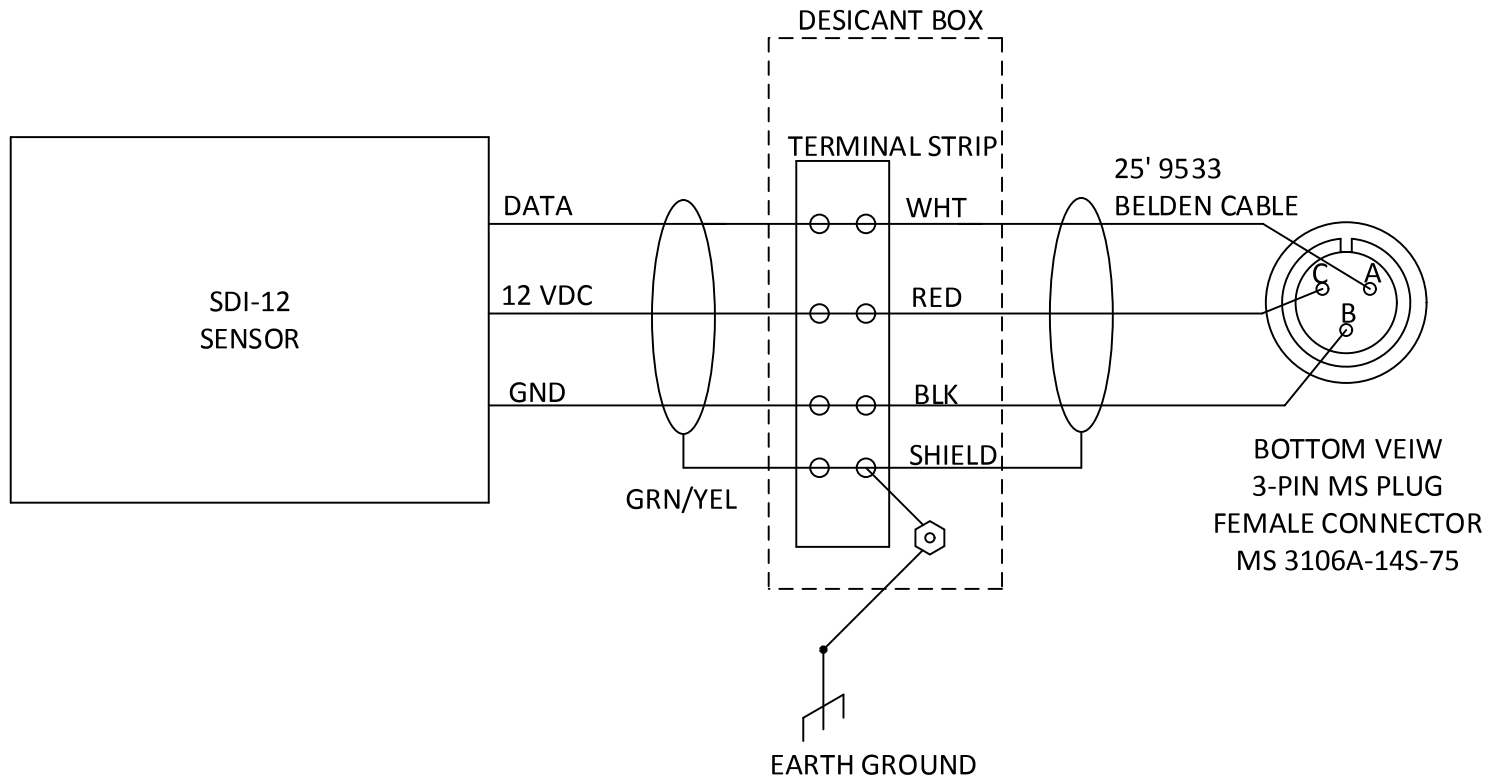
UNLESS OTHERWISE SPECIFIED: DIMENSIONS ARE IN INCHES TOLERANCES FRACTIONS = ± .XX = ± .XXX = ±	MODEL USAGE				
	MAT'L			MODEL NO.	50386
	FINISH	DRAWN BY J blackmore	DATE 8/15/01	TITLE	CABLE, SDI-12 SENSOR SIGNAL
TREATMENT	CHECKED BY D.LEADER	DATE 8/23/17	SIZE	A	DWG NO. VS108150
			EXTERNAL		REV
			WIRING DIAGRAM		2



	1	CORRECT PLUG MODEL NUMBER	6/19/17	
	ECN#	DESCRIPTION	DATE	
UNLESS OTHERWISE SPECIFIED: DIMENSIONS ARE IN INCHES TOLERANCES FRACTIONS = ± .XX = ± .XXX = ±	MODEL USAGE			
	MODEL NO.			50386
	TITLE			CABLE, SDI-12 SENDOR SIGNAL
MAT'L			EXTERNAL W/BOX	
FINISH	DRAWN BY Z. BROWN	DATE 11-06	DWG TYPE WIRING DIAGRAM	
TREATMENT	CHECKED BY J. Matteucci	DATE 6/19/17	SIZE A	
		DWG NO.	VS108435	
		REV	1	

- NOTES: 1. CABLE IS BELDEN #9533, 3 COND., 24 AWG, SHIELDED.
 CABLE LENGTH IS 10 FT.
 2. NOTE JUMPER 6 TO 4
 USE INSULATED GREEN WIRE 24 AWG.
 3. NOTE JUMPER 7 TO 8.
 USE BARE BUS WIRE, 24 AWG.

PIN #	COLOR
2	RED
3	WHITE
4	GREEN
5	BLACK
6	GREEN
7	JUMPER
8	JUMPER

9-PIN "D"
 FEMALE CONNECTOR
 WITH HOOD

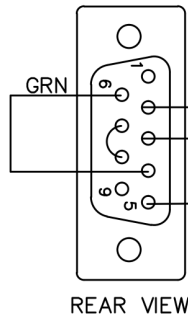

REAR VIEW

9-PIN "D"
 FEMALE CONNECTOR
 WITH HOOD

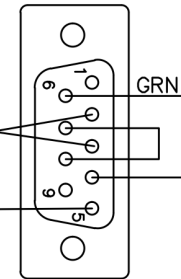

REAR VIEW

PIN #	COLOR
2	WHITE
3	RED
4	GREEN
5	BLACK
6	GREEN
7	JUMPER
8	JUMPER

	N/A	REDRAWN ON NEW BORDER	12/15/99
	ECN#	DESCRIPTION	DATE
UNLESS OTHERWISE SPECIFIED: DIMENSIONS ARE IN INCHES TOLERANCES	MODEL USAGE		
FRACTIONS = ±			
.XX = ±			
.XXX = ±			
MAT'L			MODEL NO. 5071C-50386-1
FINISH	DRAWN BY B. SCHWALL		TITLE CONSOLE CABLE
TREATMENT	CHECKED BY	DATE 4-09-03	RS232
			DWG TYPE WIRING DIAGRAM
		SIZE A	DWG NO. AC108151
			REV B

NOTES:

1 REMOVE THREADED CONNECTOR RING ON 7 PIN FEMALE CONNECTOR .

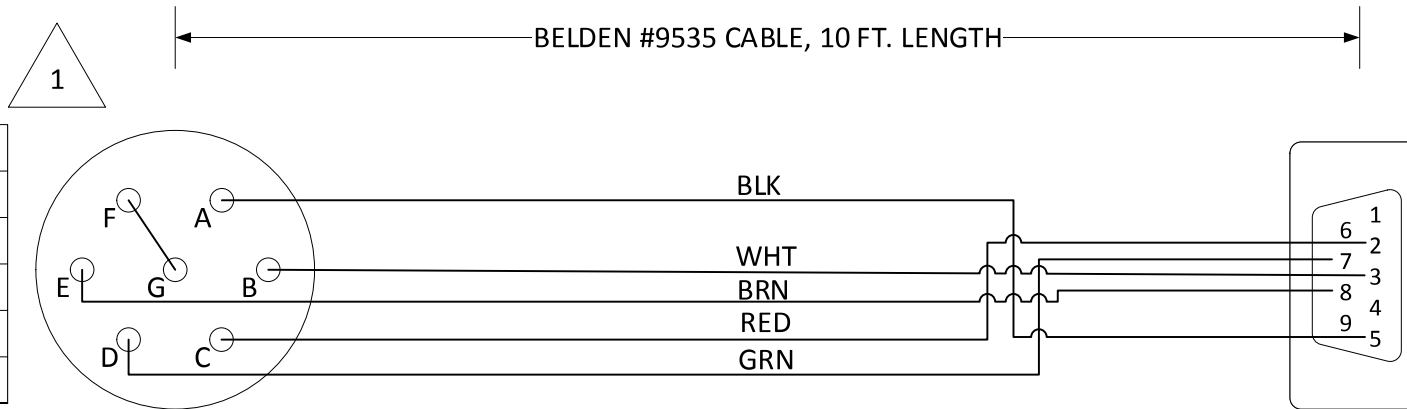

PIN #	COLOR
A	BLK
B	WHT
C	RED
D	GRN
E	BRN

PIN #	COLOR
2	RED
3	WHT
5	BLK
7	GRN
8	BRN

7 PIN FEMALE CONNECTOR REAR VIEW
 50386 ALERT TRANSMITTER, RS232 CONNECTOR
 CABEL END WITH CLAMP
 MS3106A-16S-1S & 97-3057-1008

9 PIN D FEMALE REAR VIEW
 WITH CONNECTOR HOOD

2	CHANGED NOTES	11/29/2017
1	ADDED 5096 TO MODEL USAGE	10/16/15
ECN#	DESCRIPTION	DATE

UNLESS OTHERWISE SPECIFIED: DIMESNIONS ARE IN INCHES TOLERANCES	MODEL USAGE			
	50386			
	5096			
FRACTIONS = ±			MODEL NO.	5071C-50386-4
.XX = ±			TITLE	CABLE, RS232
.XXX = ±				7-PIN EXTERNAL
MAT'L			WIRING DIAGRAM	
FINISH	DRAWN BY David C. Leader	DATE 10/16/15	DWG TYPE	
TREATMENT	CHECKED BY J. MATTEUCCI	DATE 11/29/17	SIZE A	REV 2
			DWG NO.	VS108148

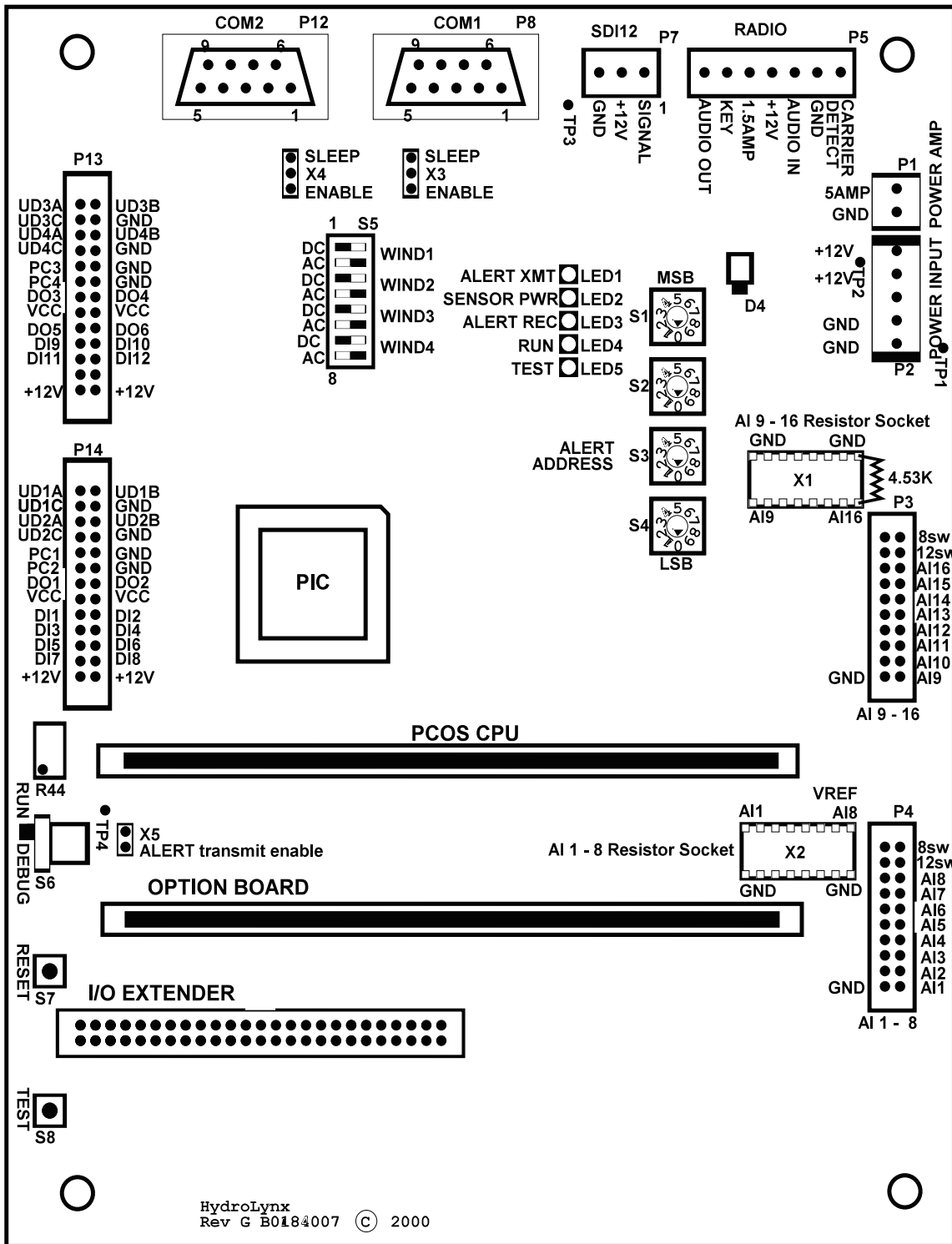

50386

Board Layout

WP108116-2



Maintenance Report

Document Number WP104973

SITE INFORMATION					
Location:		Gauge type:		ID#:	
Purpose/Comments:					
Weather conditions:					
EQUIPMENT INFORMATION					
Equipment	Model #	Asset #	Comments		
Data transmitter					
Antenna					
Battery					
Solar panel					
Sensors					
TEST DATA					
POWER					
Battery voltage	w/o load:	Vdc	w/ load:	Vdc	Difference: Vdc
Current	Standby:	µA	w/ load:	A	
Solar panel	w/o load:	Vdc	w/ load:	A	Reverse: mA
SIGNAL OUT - TX					
Power out:	W	Reverse power:	W	Freq error:	Hz Dev: ± kHz
SIGNAL IN - SENSOR					
Sensor	Measured	Reading	Comments		
COMMENTS					



50386 Test Results

Document Number WD100898-3

Model number:	PCB serial number:
Customer:	Chassis serial number:
Transmit frequency:	Transmitter serial number:
Receive frequency:	Receiver serial number:
Single/Dual antenna:	Power Amp serial number:
Additional equipment:	

PCB CHECK

By:

Date:

Preliminary Check	Serial Number <input type="checkbox"/>	PCB Inspection <input type="checkbox"/>	Burn-in <input type="checkbox"/>
Switches / Jumpers	Pulse Input Switches <input type="checkbox"/>	Batt Input Resistor <input type="checkbox"/>	Jumpers X3, X4 & X5 <input type="checkbox"/>
COM1 / Power On	COM1 <input type="checkbox"/>	Vcc <input type="checkbox"/>	Stand-by Current <input type="checkbox"/>
Switches	ID Switches <input type="checkbox"/>	RUN / DEBUG <input type="checkbox"/>	RESET / TEST <input type="checkbox"/>
System	LED's <input type="checkbox"/>	COM2 <input type="checkbox"/>	12Vsw, VRef <input type="checkbox"/>
Radio Port	TX Pwr / PTT / PA <input type="checkbox"/>	Alert RX <input type="checkbox"/>	TX Tone Adj <input type="checkbox"/>
Analog (AI) <input type="checkbox"/>	Up/Down (UD) <input type="checkbox"/>	Pulse (PC) <input type="checkbox"/>	Digital In (DI) <input type="checkbox"/>
Digital Out (DO) <input type="checkbox"/>	SDI-12 <input type="checkbox"/>	Watchdog Timer <input type="checkbox"/>	Powerdown Timer <input type="checkbox"/>

UNIT TEST

By:

Date:

AC Power Adjust <input type="checkbox"/>	Radio Harness <input type="checkbox"/>	Configuration:					
RAM Batt <input type="checkbox"/>	COM3, 4, 5, 6 <input type="checkbox"/>	ADC Calibration : _____ Vdc					
AI-1 <input type="checkbox"/>	AI-2 <input type="checkbox"/>	AI-3 <input type="checkbox"/>	AI-4 <input type="checkbox"/>	AI-5 <input type="checkbox"/>	AI-6 <input type="checkbox"/>	AI-7 <input type="checkbox"/>	Vref <input type="checkbox"/>
AI-9 <input type="checkbox"/>	AI-10 <input type="checkbox"/>	AI-11 <input type="checkbox"/>	AI-12 <input type="checkbox"/>	AI-13 <input type="checkbox"/>	AI-14 <input type="checkbox"/>	AI-15 <input type="checkbox"/>	BATT <input type="checkbox"/>
UD-1 <input type="checkbox"/>	UD-2 <input type="checkbox"/>	UD-3 <input type="checkbox"/>	UD-4 <input type="checkbox"/>	PC-1 <input type="checkbox"/>	PC-2 <input type="checkbox"/>	PC-3 <input type="checkbox"/>	PC-4 <input type="checkbox"/>
DI <input type="checkbox"/>	DO <input type="checkbox"/>	SDI-12 <input type="checkbox"/>					

RADIO TEST

By:

Date:

TRANSMIT	Deviation:± kHz	Freq. Error: Hz	Power Out: W
RECEIVE	Audio Out: Vpp	F.E. (Selectivity) kHz	Squelch (Sensitivity) μ V
REPEATER	Pass/Reject <input type="checkbox"/>	Talk Back <input type="checkbox"/>	RX while TX <input type="checkbox"/>

FINAL INSPECTION

By:

Date:

Self Report <input type="checkbox"/>	Burn In <input type="checkbox"/>	Serial Tag <input type="checkbox"/>	Neat/Complete <input type="checkbox"/>
Silkscreen <input type="checkbox"/>	Connectors <input type="checkbox"/>	Wiring/Solder <input type="checkbox"/>	Fasteners <input type="checkbox"/>
Dust Cover <input type="checkbox"/>	Strain Relief <input type="checkbox"/>	Desiccant <input type="checkbox"/>	Lid/Cover <input type="checkbox"/>
Notes:			

5096 -- 5096N TRANSMISSION FORMATS

ASCII FORMAT

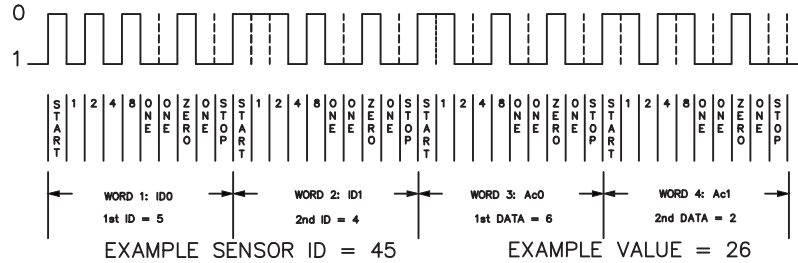

WIND FORMAT

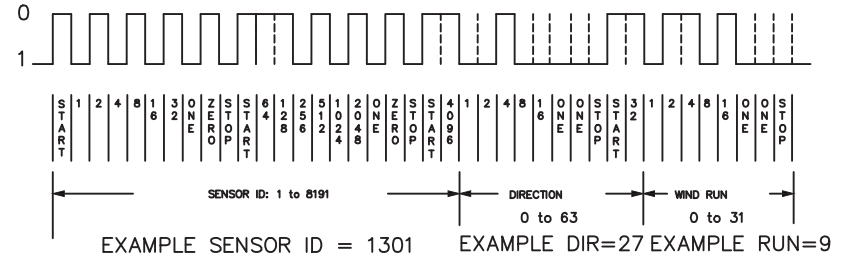

BINARY FORMAT

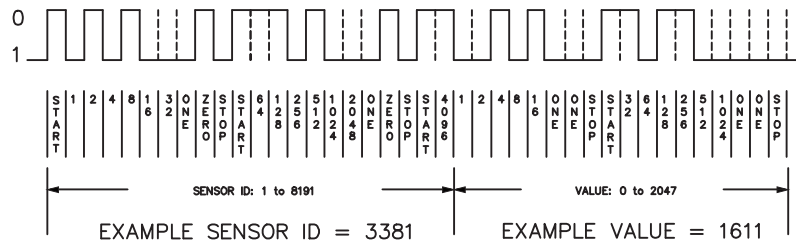

ENHANCED ALERT FORMAT

$$6 \text{ BIT CRC POLYNOMIAL} = X^6 + X^4 + X^3 + 1$$

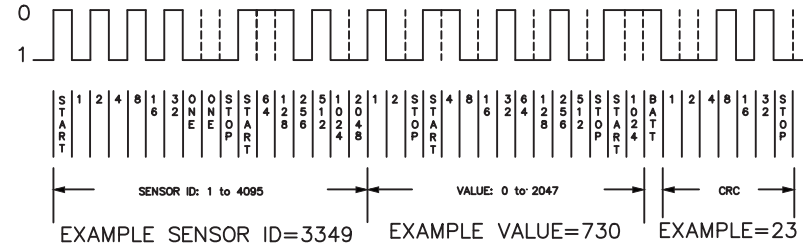

ENHANCED IFLOWS FORMAT

$$6 \text{ BIT CRC POLYNOMIAL} = X^6 + X^4 + X^3 + 1$$

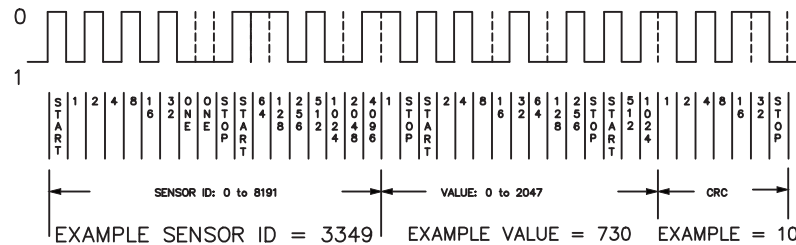

N/A	REDRAWN ON NEW BORDER	10/7/98
960901	ADD IFLOWS/ CORRECTIONS	9/26/96
ECN#	DESCRIPTION	DATE
MODEL USAGE		
MODEL NO.		
TITLE		
SPECIFICATION, TRANSMISSION FORMAT		
DRAWN BY MYERS	DATE 10/7/98	DWG TYPE FORMATS FOR MODEL 5096&5096N
CHECKED BY	DATE	SIZE B
DWG NO. AC107484		REV B

APPENDIX D
FCC Radio Station Authorization



Federal Communications Commission
Wireless Telecommunications Bureau

RADIO STATION AUTHORIZATION

LICENSEE: CITY OF BUDA

ATTN: JOHN P. NETT
CITY OF BUDA
121 MAIN STREET
BUDA, TX 78610

Call Sign WRBT368	File Number 0008171569
Radio Service IG - Industrial/Business Pool, Conventional	
Regulatory Status PMRS	
Frequency Coordination Number	

FCC Registration Number (FRN): 0027422351

Grant Date 06-13-2018	Effective Date 06-13-2018	Expiration Date 06-13-2028	Print Date 06-14-2018
---------------------------------	-------------------------------------	--------------------------------------	---------------------------------

STATION TECHNICAL SPECIFICATIONS

Fixed Location Address or Mobile Area of Operation

- Loc. 1 Address: Onion Creek Bridge at FM 967
City: Buda County: HAYS State: TX
Lat (NAD83): 30-05-10.8 N Long (NAD83): 097-50-55.3 W ASR No.: Ground Elev: 687.0
- Loc. 2 Address: Cole Springs Rd at Old Black Colony Rd
City: Buda County: HAYS State: TX
Lat (NAD83): 30-05-11.0 N Long (NAD83): 097-50-56.1 W ASR No.: Ground Elev: 685.0
- Loc. 3 Address: FM 967 at Garlic Creek West
City: Buda County: HAYS State: TX
Lat (NAD83): 30-06-03.4 N Long (NAD83): 097-51-22.4 W ASR No.: Ground Elev: 738.0
- Loc. 4 Address: FM 967 at Garlic Creek East
City: Buda County: HAYS State: TX
Lat (NAD83): 30-06-02.6 N Long (NAD83): 097-50-56.9 W ASR No.: Ground Elev: 715.0
- Loc. 5 Address: Bluff Street at Peach Street
City: Buda County: HAYS State: TX
Lat (NAD83): 30-04-52.6 N Long (NAD83): 097-50-47.9 W ASR No.: Ground Elev: 687.0
- Loc. 6 Address: FM 967 at Bluff Street
City: Buda County: HAYS State: TX
Lat (NAD83): 30-04-58.2 N Long (NAD83): 097-50-45.1 W ASR No.: Ground Elev: 697.0

Conditions:

Pursuant to §309(h) of the Communications Act of 1934, as amended, 47 U.S.C. §309(h), this license is subject to the following conditions: This license shall not vest in the licensee any right to operate the station nor any right in the use of the frequencies designated in the license beyond the term thereof nor in any other manner than authorized herein. Neither the license nor the right granted thereunder shall be assigned or otherwise transferred in violation of the Communications Act of 1934, as amended. See 47 U.S.C. § 310(d). This license is subject in terms to the right of use or control conferred by §706 of the Communications Act of 1934, as amended. See 47 U.S.C. §606.

Licensee Name: CITY OF BUDA

Call Sign: WRBT368

File Number: 0008171569

Print Date: 06-14-2018

Antennas

Loc No.	Ant No.	Frequencies (MHz)	Sta.Cls.	No. Units	No. Pagers	Emission Designator	Output Power (watts)	ERP (watts)	Ant. Ht./Tp meters	Ant. AAT meters	Construct Deadline Date
1	1	000170.31250000	FXO	1	4	11K0F2D	5.000	7.000	1.0	6.0	06-13-2019
2	1	000170.31250000	FXO	1	4	11K0F2D	5.000	7.000	1.0	6.0	06-13-2019
3	1	000170.31250000	FXO	1	4	11K0F2D	5.000	7.000	1.0	6.0	06-13-2019
4	1	000170.31250000	FXO	1	4	11K0F2D	5.000	7.000	1.0	6.0	06-13-2019
5	1	000170.31250000	FXO	1	4	11K0F2D	5.000	7.000	1.0	6.0	06-13-2019
6	1	000170.31250000	FXO	1	4	11K0F2D	5.000	7.000	1.0	6.0	06-13-2019

Control Points

Control Pt. No. 1

Address: 2171 Yarrington Rd.

City: San Marcos County: HAYS State: TX Telephone Number: (512)393-7300

Control Pt. No. 2

Address: 111 Green Acres Dr.

City: Wimberley County: HAYS State: TX Telephone Number: (512)847-3536

Control Pt. No. 3

Address: 3502 FM 967

City: Buda County: HAYS State: TX Telephone Number: (512)295-4248

Control Pt. No. 4

Address: 400 Sportsplex

City: Dripping Springs County: HAYS State: TX Telephone Number: (512)894-0704

Associated Call Signs

Waivers/Conditions:

NONE

APPENDIX E
TWDB Comments on Draft Report

Texas Water Development Board

P.O. Box 13231, 1700 N. Congress Ave.
Austin, TX 78711-3231, www.twdb.texas.gov
Phone (512) 463-7847, Fax (512) 475-2053

Mr. Kenneth R. Williams
City Manager, City of Buda
P.O. Box 1380
Buda, Texas 78641-1216

RE: Flood Protection Grant Contract with City of Buda, Contract No. 1600012037, Comments on Draft Report Entitled "City of Buda Flood Early Warning System"

Dear Mr. Williams:

Staff members of the Texas Water Development Board (TWDB) have completed a review of the draft report prepared under the above-referenced contract. ATTACHMENT 1 provides the comments resulting from this review. As stated in the TWDB contract, the City of Buda will consider revising the final report in response to comments from the Executive Administrator and other reviewers. In addition, the City of Buda will include a copy of the Executive Administrator's draft report comments in the Final Report.

Please note: The TWDB logo should not be used in your Final Report.

The TWDB's Contract Administration staff looks forward to receiving one (1) electronic copy of the entire Final Report in Portable Document Format (PDF) and five (5) bound double-sided copies. **Please further note, that in compliance with Texas Administrative Code Chapters 206 and 213 (related to Accessibility and Usability of State Web Sites), the digital copy of the final report must comply with the requirements and standards specified in statute. For more information, visit <http://www.sos.state.tx.us/tac/index.shtml>.** If you have any questions on accessibility, please contact David Carter with the Contract Administration Division at (512) 936-6079 or david.carter@twdb.texas.gov.

City of Buda shall also submit one (1) electronic copy of any computer programs or models, and, if applicable, an operations manual developed under the terms of this Contract.

If you have any questions or need any further information, please feel free to contact Ms. Sara Husted of our Flood Mitigation Planning staff at 512-936-0129 or sara.husted@twdb.texas.gov.

Sincerely,

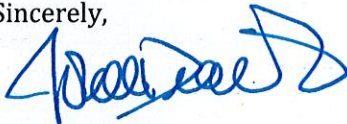

John T. Dupnik, P.G.
Deputy Executive Administrator
Water Science and Conservation

Date: 4-23-19

Enclosures

c w/o enc.: Ms. Sara Husted, Flood Mitigation Planning

Our Mission

To provide leadership, information, education, and support for planning, financial assistance, and outreach for the conservation and responsible development of water for Texas

Board Members

Peter M. Lake, Chairman | Kathleen Jackson, Board Member | Brooke T. Paup, Board Member
Jeff Walker, Executive Administrator

ATTACHMENT 1

City of Buda Flood Early Warning System

City of Buda

Contract #1600012037

Texas Water Development Board Comments to Draft Report

REQUIRED CHANGES

General Draft Report Comments:

In general, the study follows standard methodologies and practice. Mitigation alternatives identified may be eligible for funding under the Texas Water Development Board's financial assistance programs. Application requirements and eligibility criteria are identified by Texas Water Development Board rules specified in Section 363 of the Texas Administrative Code (TAC). The report would be appropriate for use in support of an application to the Board for financing the proposed improvements. All additional information required by Board rules, 31 TAC 363.401-404, as well as necessary information to make legal findings as required by Texas Water Code chapter 17.771-776, would be required at the time of loan application.

Please conduct a final edit of the document for grammar, spelling, typographical errors, and inconsistent usage of acronyms, and abbreviations. Please spell out all acronyms, with the acronym in parentheses, the first time they are used. Please include a list of acronyms used in the report after the Table of Contents. A version of the draft report, with the Texas Water Development Board's tracked edits, will be provided to the City's consultant for the draft report update, simultaneously, with the mailing of these comments.

Specific Draft Report Comments:

1. All Appendices (Word Doc Version) – Page 19-27; Please include all Resolutions, Construction Plan, and Equipment Manual documents which are referenced but not included. Please also include FCC Radio Station Authorization for Appendix D.
2. Appendix A (Word Doc Version) – Page 4; Does not have a title. Should be "City of Buda Resolution No. 2016-R-11".
3. The application and Scope of Work both indicated that Priority #3, Main Street at Bradfield Park, was a site location while this site is not mentioned in the report. Please provide a discussion on why a Flood Early Warning System was not installed at this site.



Designed:	EEC
Drawn:	EEC
Checked:	MLR
Edt:	2-8-2018

Title:	50047 - FM 967 AT BLUFF STREET SITE AERIAL VIEW
Filepath:	P:\A641-City of BUDA TEXAS Flashers\AutoCAD\Construction Drawings\50047 - FM 967 at Bluff Street\50047 - FM 967 AT BLUFF STREET.dwg

Scale:	NOT TO SCALE
Copy:	CONSTRUCTION PLANS

Project No:	A641
Drawing:	1



Note: All conduit straps will be secured with stainless steel expansion anchor bolts sealed with concrete epoxy

Conduit Strap

Riser Pipe

Conduit



Designed:	EEC
Drawn:	EEC
Checked:	MLR
Edit:	2-8-2018

Title:	50047 - FM 967 AT BLUFF STREET RISER PIPE DETAIL
Filepath:	P:\A641-City of BUDA TEXAS Flashers\AutoCAD\Construction Drawings\50047 - FM 967 at Bluff Street\50047 - FM 967 AT BLUFF STREET.dwg

Scale:	NOT TO SCALE
Copy:	CONSTRUCTION PLANS

Project No:	A641
Drawing:	2



New Conduit



Designed:	EEC
Drawn:	EEC
Checked:	MLR
Edit:	2-8-2018

Title:	50047 - FM 967 AT BLUFF STREET CONDUIT DETAIL #1
Filepath:	P:\A641-City of BUDA TEXAS Flashers\AutoCAD\Construction Drawings\50047 - FM 967 at Bluff Street\50047 - FM 967 AT BLUFF STREET.dwg

Scale:	NOT TO SCALE
Copy:	CONSTRUCTION PLANS

Project No:	A641
Drawing:	3



Conduit



Designed:	EEC
Drawn:	EEC
Checked:	MLR
Edt:	2-8-2018

Title:	50047 - FM 967 AT BLUFF STREET CONDUIT DETAIL #2
Filepath:	P:\A641-City of BUDA TEXAS Flasher's\AutoCAD\Construction Drawings\50047 - FM 967 at Bluff Street\50047 - FM 967 AT BLUFF STREET.dwg

Scale:	NOT TO SCALE
Copy:	CONSTRUCTION PLANS

Project No:	A641
Drawing:	4



Conduit



Designed:	EEC
Drawn:	EEC
Checked:	MLR
Edit:	2-8-2018

Title:	50047 - FM 967 AT BLUFF STREET CONDUIT DETAIL #3
Filepath:	P:\A641-City of BUDA TEXAS Flashers\AutoCAD\Construction Drawings\50047 - FM 967 at Bluff Street\50047 - FM 967 AT BLUFF STREET.dwg

Scale:	NOT TO SCALE
Copy:	CONSTRUCTION PLANS

Project No:	A641
Drawing:	5



Conduit



Designed:	EEC
Drawn:	EEC
Checked:	MLR
Edit:	2-8-2018

Title:	50047 - FM 967 AT BLUFF STREET CONDUIT DETAIL #4
Filepath:	P:\A641-City of BUDA TEXAS Flashers\AutoCAD\Construction Drawings\50047 - FM 967 at Bluff Street\50047 - FM 967 AT BLUFF STREET.dwg

Scale:	NOT TO SCALE
Copy:	CONSTRUCTION PLANS

Project No:	A641
Drawing:	6



Designed:	EEC
Drawn:	EEC
Checked:	MLR
Edit:	2-8-2018

Title:	50047 - FM 967 AT BLUFF STREET MASTER DETAIL
Filepath:	P:\A641-City of BUDA TEXAS Flashers\AutoCAD\Construction Drawings\50047 - FM 967 at Bluff Street\50047 - FM 967 AT BLUFF STREET.dwg

Scale:	NOT TO SCALE
Copy:	CONSTRUCTION PLANS

Project No:	A641
Drawing:	7

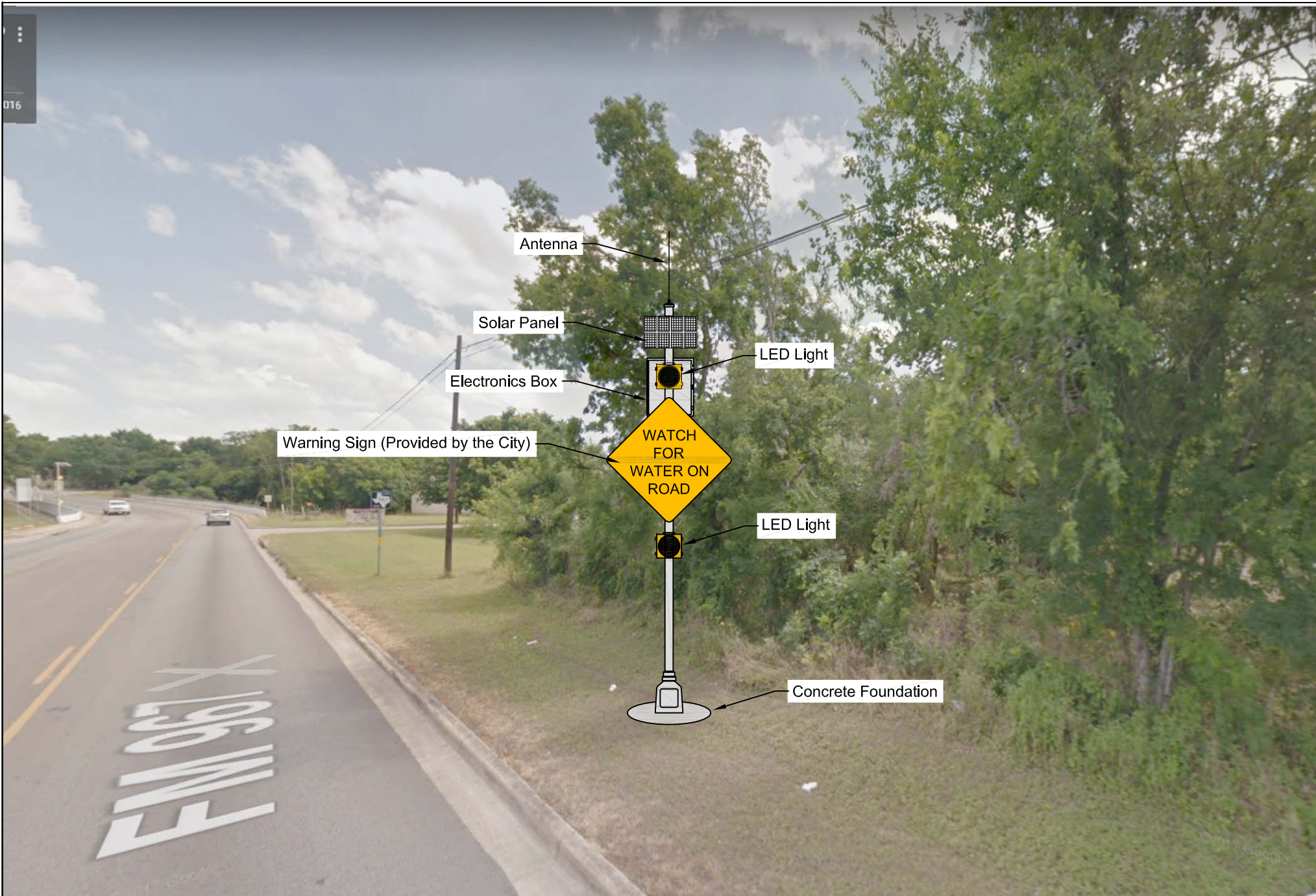

Designed:	EEC
Drawn:	EEC
Checked:	MLR
Edit:	2-8-2018

Title:	50047 - FM 967 AT BLUFF STREET SLAVE 1 FLASHER DETAIL
Filepath:	P:\A641-City of BUDA TEXAS Flashers\AutoCAD\Construction Drawings\50047 - FM 967 at Bluff Street\50047 - FM 967 AT BLUFF STREET.dwg

Scale:	NOT TO SCALE
Copy:	CONSTRUCTION PLANS

Project No:	A641
Drawing:	8



Designed:	EEC
Drawn:	EEC
Checked:	MLR
Edt:	2-8-2018

Title:	50047 - FM 967 AT BLUFF STREET SLAVE 2 FLASHER DETAIL
Filepath:	P:\A641-City of BUDA TEXAS Flashers\AutoCAD\Construction Drawings\50047 - FM 967 at Bluff Street\50047 - FM 967 AT BLUFF STREET.dwg

Scale:	NOT TO SCALE
Copy:	CONSTRUCTION PLANS

Project No:	A641
Drawing:	9

APPENDIX B.5
Onion Creek Bridge FEWS Construction Plans



Designed:	EEC
Drawn:	EEC
Checked:	MLR
Edit:	2-15-2018

Title:	50042 - ONION CREEK BRIDGE AT FM 967 SITE AERIAL VIEW
Filepath:	P:\A641-City of BUDA TEXAS Flashers\AutoCAD\Construction Drawings\50042 - Onion Creek Bridge at FM 967\50042 - ONION CREEK AT FM 967.dwg

Scale:	NOT TO SCALE
Copy:	CONSTRUCTION PLANS

Project No:	A641
Drawing:	1

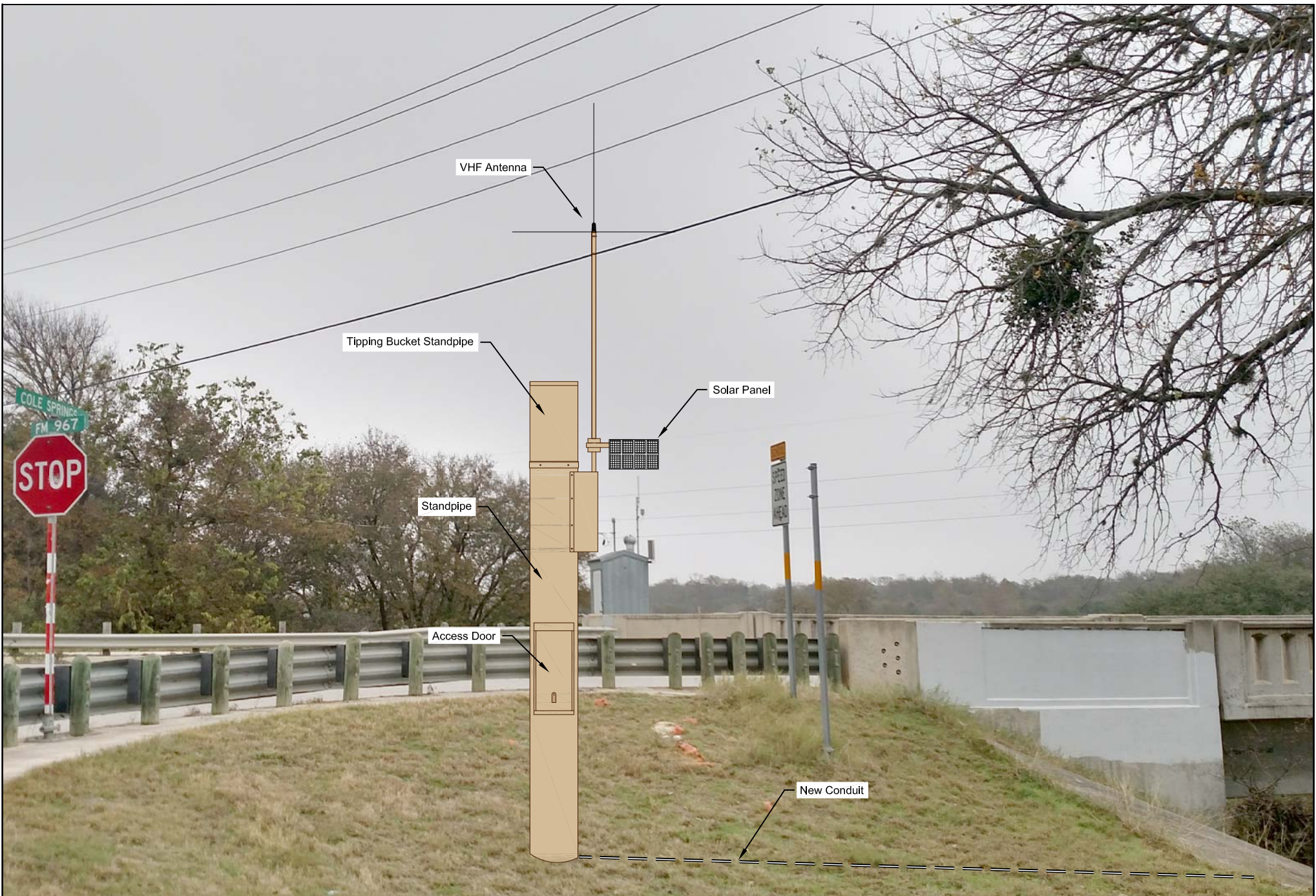

Designed: EEC
 Drawn: EEC
 Checked: MLR
 Edit: 2-15-2018

Title: 50042 - ONION CREEK BRIDGE AT FM 967
 STANDPIPE DETAIL
 Filepath: P:\A641-City of BUDA TEXAS Flashers\AutoCAD\Construction Drawings\50042 - Onion Creek Bridge at FM 967\50042 - ONION CREEK AT FM 967.dwg

Scale: NOT TO SCALE
 Copy: CONSTRUCTION PLANS

Project No: A641
 Drawing: 2



New Conduit

To Standpipe



Designed:	EEC
Drawn:	EEC
Checked:	MLR
Edit:	2-15-2018

Title:	50042 - ONION CREEK BRIDGE AT FM 967 CONDUIT DETAIL #1
Filepath:	P:\A641-City of BUDA TEXAS Flashers\AutoCAD\Construction Drawings\50042 - Onion Creek Bridge at FM 967\50042 - ONION CREEK AT FM 967.dwg

Scale:	NOT TO SCALE
Copy:	CONSTRUCTION PLANS

Project No:	A641
Drawing:	3



New Conduit



Designed:	EEC
Drawn:	EEC
Checked:	MLR
Edit:	2-15-2018

Title:	50042 - ONION CREEK BRIDGE AT FM 967 CONDUIT DETAIL #2
Filepath:	P:\A641-City of BUDA TEXAS Flashers\AutoCAD\Construction Drawings\50042 - Onion Creek Bridge at FM 967\50042 - ONION CREEK AT FM 967.dwg

Scale:	NOT TO SCALE
Copy:	CONSTRUCTION PLANS

Project No:	A641
Drawing:	4



New Conduit



Designed: EEC	Title: 50042 - ONION CREEK BRIDGE AT FM 967 CONDUIT DETAIL #3	Scale: NOT TO SCALE	Project No: A641
Drawn: EEC		Copy: CONSTRUCTION PLANS	Drawing: 5
Checked: MLR			
Edit: 2-15-2018	Filepath: P:\A641-City of BUDA TEXAS Flashers\AutoCAD\Construction Drawings\50042 - Onion Creek Bridge at FM 967\50042 - ONION CREEK AT FM 967.dwg		



Riser Pipe in Bank of Onion Creek

New Conduit



Designed:	EEC
Drawn:	EEC
Checked:	MLR
Edit:	2-15-2018

Title:	50042 - ONION CREEK BRIDGE AT FM 967 CONDUIT DETAIL #4
Filepath:	P:\A641-City of BUDA TEXAS Flashers\AutoCAD\Construction Drawings\50042 - Onion Creek Bridge at FM 967\50042 - ONION CREEK AT FM 967.dwg

Scale:	NOT TO SCALE
Copy:	CONSTRUCTION PLANS

Project No:	A641
Drawing:	6



Riser pipe will be concreted into bank of Onion Creek

New Conduit

Riser Pipe



Designed:	EEC
Drawn:	EEC
Checked:	MLR
Edit:	2-15-2018

Title:	50042 - ONION CREEK BRIDGE AT FM 967 RISER PIPE DETAIL
Filepath:	P:\A641-City of BUDA TEXAS Flashers\AutoCAD\Construction Drawings\50042 - Onion Creek Bridge at FM 967\50042 - ONION CREEK AT FM 967.dwg

Scale:	NOT TO SCALE
Copy:	CONSTRUCTION PLANS

Project No:	A641
Drawing:	7

APPENDIX B.6
Cole Springs Road FEWS Construction Plans



Designed:	EEC
Drawn:	EEC
Checked:	MLR
Edt:	2-7-2018

Title:	50043 - COLE SPRINGS ROAD AT OLD BLACK COLONY RD SITE AERIAL VIEW
Filepath:	P:\A641-City of BUDA TEXAS Flashers\AutoCAD\Construction Drawings\50043 - Cole Springs Rd\50043 - COLE SPRINGS RD.dwg

Scale:	NOT TO SCALE
Copy:	CONSTRUCTION PLANS

Project No:	A641
Drawing:	1

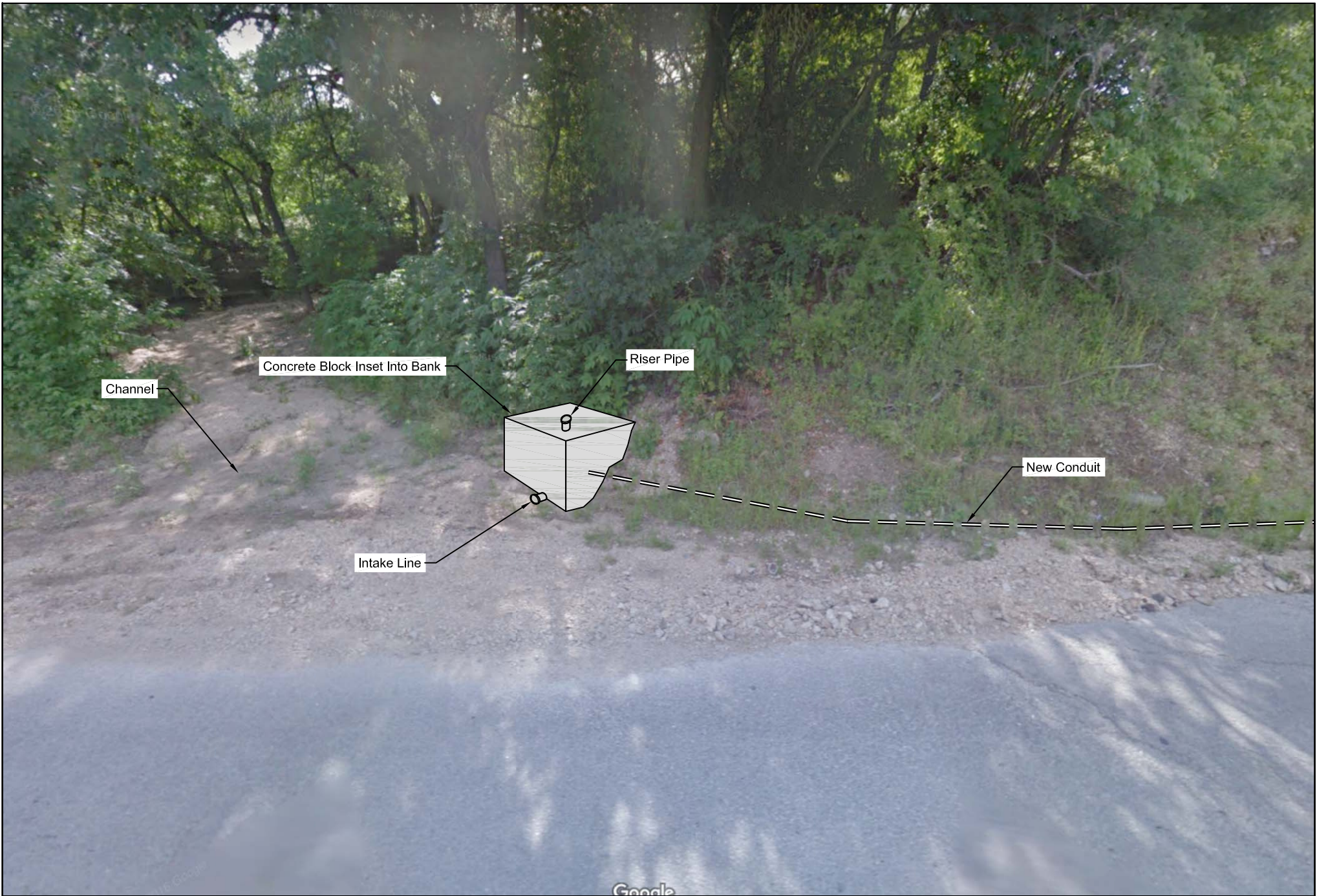

Designed:	EEC
Drawn:	EEC
Checked:	MLR
Edit:	2-7-2018

Title:	50043 - COLE SPRINGS ROAD AT OLD BLACK COLONY RD RISER PIPE DETAIL
	Filepath: P:\A641-City of BUDA TEXAS Flashers\AutoCAD\Construction Drawings\50043 - Cole Springs Rd\50043 - COLE SPRINGS RD.dwg

Scale:	NOT TO SCALE
Copy:	CONSTRUCTION PLANS

Project No:	A641
Drawing:	2



New Conduit



Designed: EEC
 Drawn: EEC
 Checked: MLR
 Edit: 2-7-2018

Title: 50043 - COLE SPRINGS ROAD AT
 OLD BLACK COLONY RD
 CONDUIT DETAIL
 Filepath: P:\A641-City of BUDA TEXAS Flashers\AutoCAD\Construction Drawings\50043 - Cole Springs Rd\50043 - COLE SPRINGS RD.dwg

Scale: NOT TO SCALE
 Copy: CONSTRUCTION PLANS

Project No: A641
 Drawing: 3

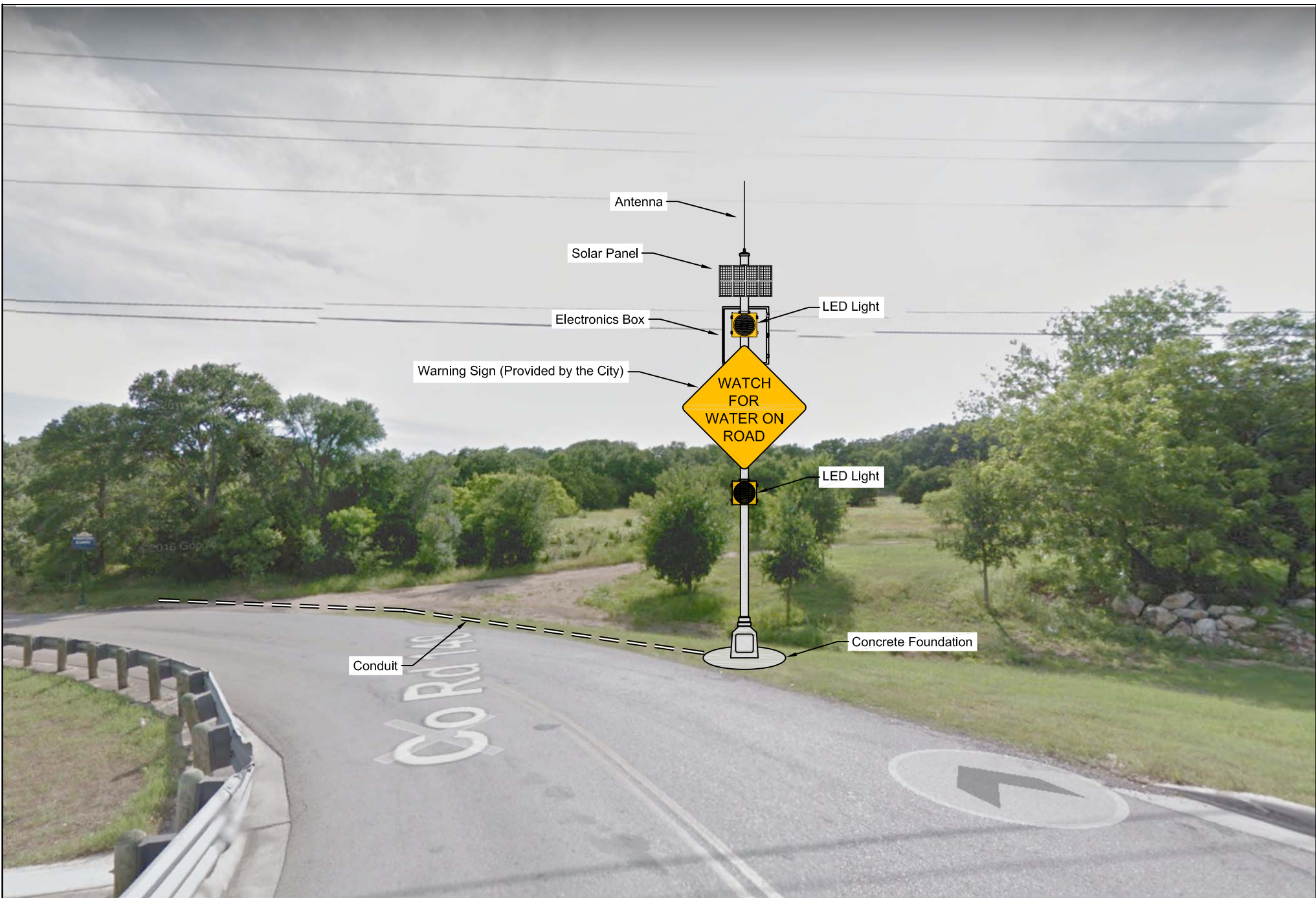



Designed:	EEC
Drawn:	EEC
Checked:	MLR
Edit:	2-7-2018

Title:	50043 - COLE SPRINGS ROAD AT OLD BLACK COLONY RD SLAVE 1 FLASHER DETAIL
	Filepath: P:\A641-City of BUDA TEXAS Flashers\AutoCAD\Construction Drawings\50043 - Cole Springs Rd\50043 - COLE SPRINGS RD.dwg

Scale:	NOT TO SCALE
Copy:	CONSTRUCTION PLANS

Project No:	A641
Drawing:	5

RESOLUTION NO. 2016-R-11

A RESOLUTION OF THE CITY OF BUDA, TEXAS, APPOINTING THE CITY MANAGER AS THE CHIEF EXECUTIVE OFFICER AND AUTHORIZED REPRESENTATIVE TO ACT IN ALL MATTERS IN CONNECTION WITH THE TEXAS WATER DEVELOPMENT BOARD (TWDB) FLOOD PROTECTION GRANT PROJECT AND COMMITTING THE CITY TO PROVIDE MATCHING FUNDS TO SECURE AND COMPLETE THE TWDB FLOOD PROTECTION GRANT.

WHEREAS, the City of Buda is developing an application for TWDB Flood Protection Grant Funds to install flood early warning systems (FEWS);

WHEREAS, TWDB Flood Protection Grant Fund applicants are required to appoint an official to act as the Authorized Representative in all matters in connection with the Flood Protection Grant;

WHEREAS, TWDB Flood Protection Grant Fund applicants are required to commit 50% or more matching funds to secure and complete the TWDB Flood Protection Grant.

NOW, THEREFORE, BE IT RESOLVED BY THE CITY COUNCIL OF THE CITY OF BUDA:

- Section 1. That the City of Buda is authorized to submit an application for TWDB Flood Protection Grant Funds to install flood early warning systems (FEWS);
- Section 2. That the City Manager be appointed the Chief Executive Officer and Authorized Representative to act on behalf of the City in all matters in connection with the TWDB Flood Protection Project;
- Section 3. That the City is committing to provide 50% or more matching funds in contribution to the TWDB Flood Protection Project.

PASSED AND APPROVED this 7th day of June, 2016.

THE CITY OF BUDA, TEXAS



Todd Ruge, Mayor

ATTEST:

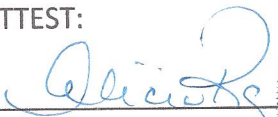

Alicia Ramirez, City Secretary

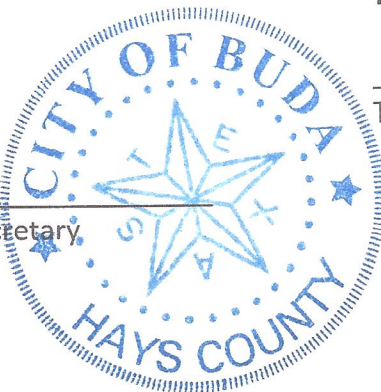

APPENDIX B.1
RM 967 at Garlic Creek West FEWS Construction Plans

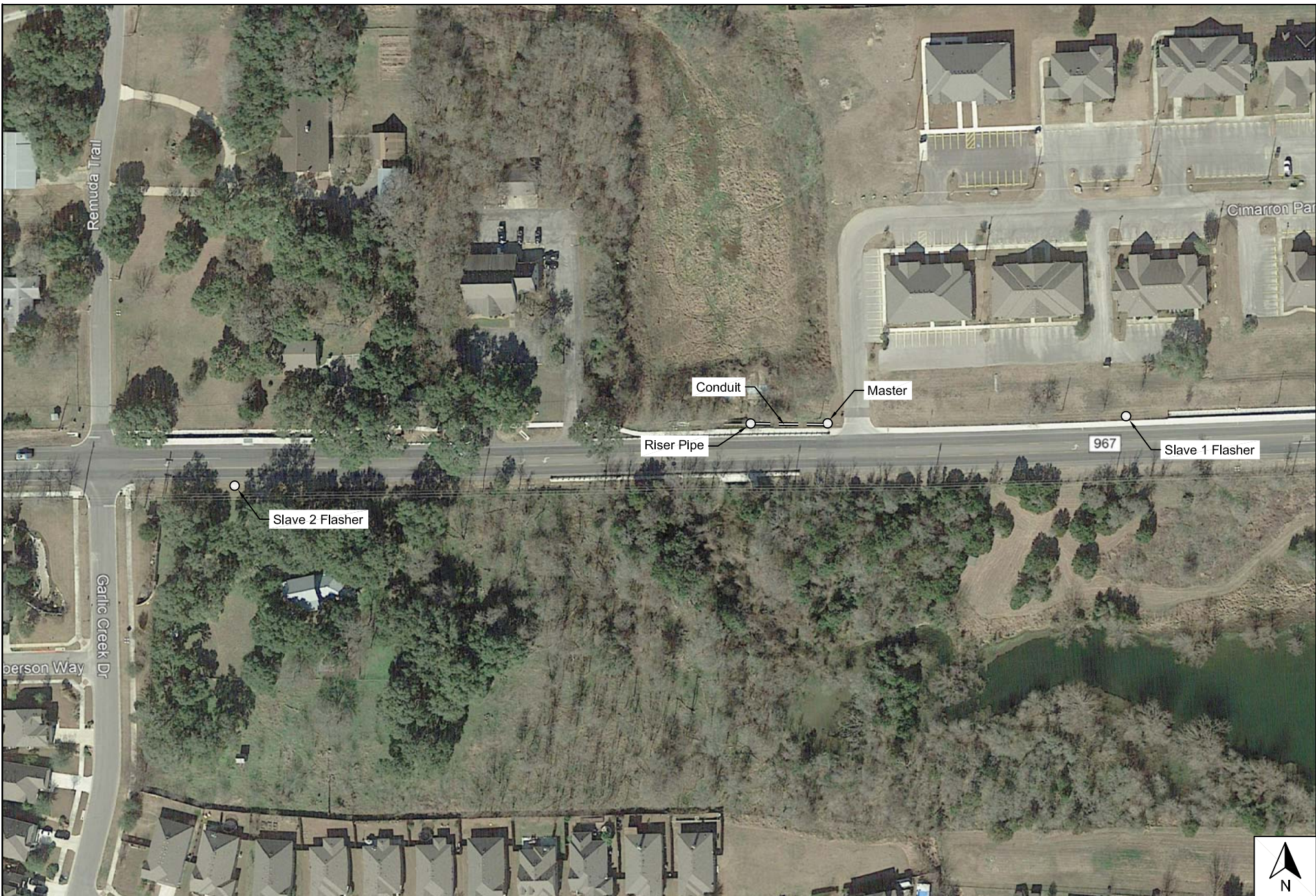

Designed: EEC
 Drawn: EEC
 Checked: MLR
 Edit: 2-7-2018

Title: 50044 - FM 967 AT GARLIC CREEK WEST
 SITE AERIAL VIEW
 Filepath: P:\A641-City of BUDA TEXAS Flashers\AutoCAD\Construction Drawings\50044 - FM 967 at Garlic Creek West\50044 - FM 967 AT GARLIC CREEK WEST.dwg

Scale: NOT TO SCALE
 Copy: CONSTRUCTION PLANS

Project No: A641
 Drawing: 1



Conduit

Note: All conduit straps will be secured with stainless steel expansion anchor bolts sealed with concrete epoxy

Riser Pipe

Conduit Strap



Designed:	EEC
Drawn:	EEC
Checked:	MLR
Edit:	2-7-2018

Title:	50044 - FM 967 AT GARLIC CREEK WEST RISER PIPE DETAIL
Filepath:	P:\A641-City of BUDA TEXAS Flashers\AutoCAD\Construction Drawings\50044 - FM 967 at Garlic Creek West\50044 - FM 967 AT GARLIC CREEK WEST.dwg

Scale:	NOT TO SCALE
Copy:	CONSTRUCTION PLANS

Project No:	A641
Drawing:	2



Designed:	EEC
Drawn:	EEC
Checked:	MLR
Edt:	2-7-2018

Title:	50044 - FM 967 AT GARLIC CREEK WEST MASTER DETAIL
Filepath:	P:\A641-City of BUDA TEXAS Flashers\AutoCAD\Construction Drawings\50044 - FM 967 at Garlic Creek West\50044 - FM 967 AT GARLIC CREEK WEST.dwg

Scale:	NOT TO SCALE
Copy:	CONSTRUCTION PLANS

Project No:	A641
Drawing:	3

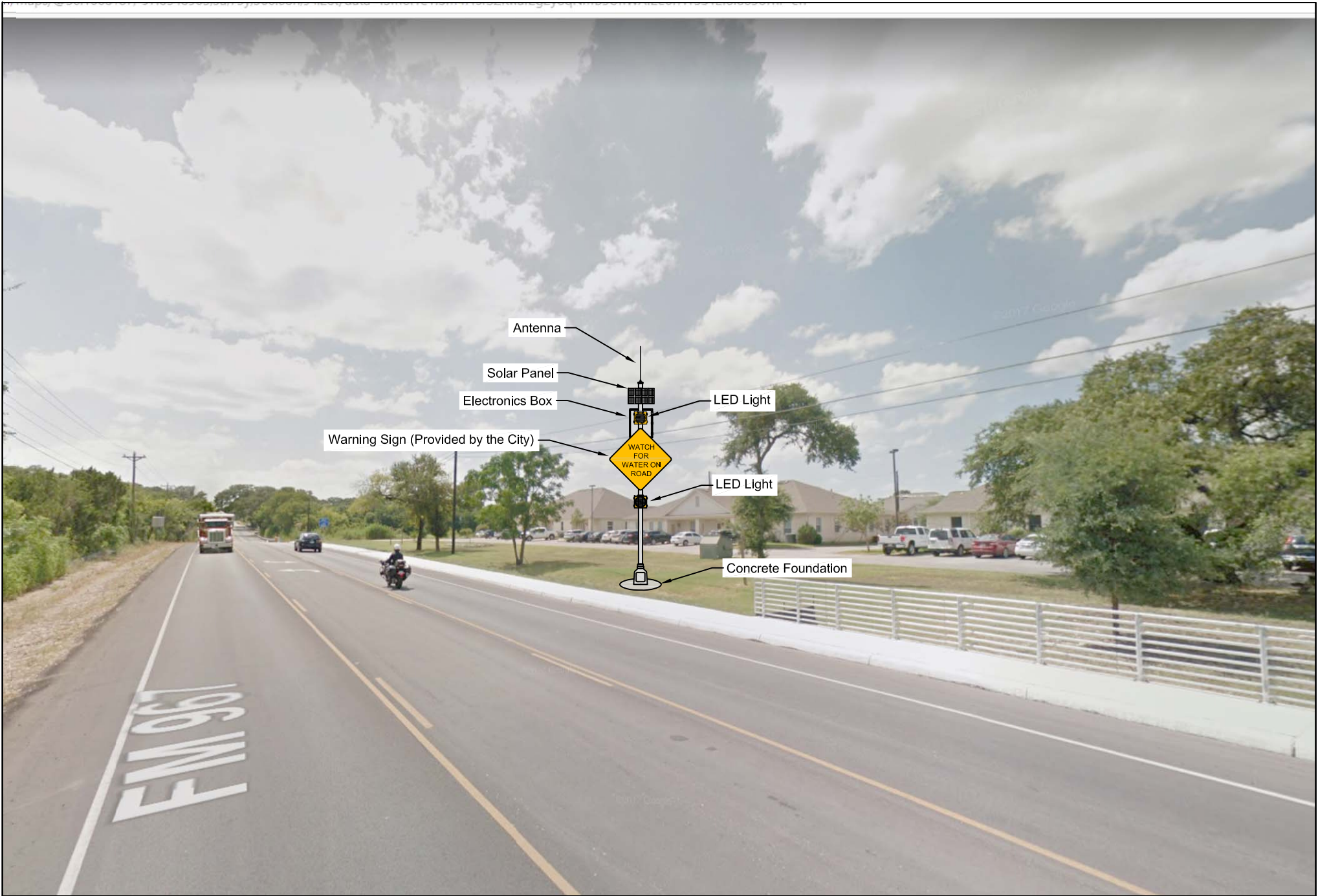

Designed:	EEC
Drawn:	EEC
Checked:	MLR
Edit:	2-7-2018

Title:	50044 - FM 967 AT GARLIC CREEK WEST SLAVE 1 FLASHER DETAIL
Filepath:	P:\A641-City of BUDA TEXAS Flashers\AutoCAD\Construction Drawings\50044 - FM 967 at Garlic Creek West\50044 - FM 967 AT GARLIC CREEK WEST.dwg

Scale:	NOT TO SCALE
Copy:	CONSTRUCTION PLANS

Project No:	A641
Drawing:	4

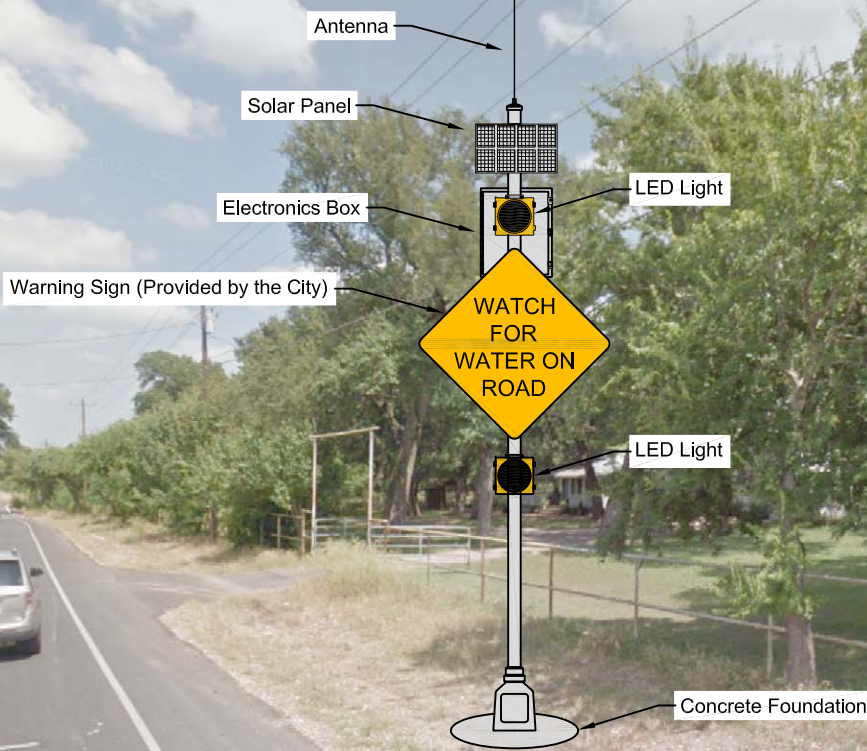

Google



Designed:	EEC
Drawn:	EEC
Checked:	MLR
Edit:	2-7-2018

Title:	50044 - FM 967 AT GARLIC CREEK WEST SLAVE 2 FLASHER DETAILS
Filepath:	P:\A641-City of BUDA TEXAS Flashers\AutoCAD\Construction Drawings\50044 - FM 967 at Garlic Creek West\50044 - FM 967 AT GARLIC CREEK WEST.dwg

Scale:	NOT TO SCALE
Copy:	CONSTRUCTION PLANS

Project No:	A641
Drawing:	5

APPENDIX B.2
RM 967 at Garlic Creek East FEWS Construction Plans



Designed:	EEC
Drawn:	EEC
Checked:	MLR
Edit:	2-7-2018

Title:	50045 - FM 967 AT GARLIC CREEK EAST SITE AERIAL VIEW
Filepath:	P:\A641-City of BUDA TEXAS Flashers\AutoCAD\Construction Drawings\50045 - FM 967 at Garlic Creek East\50045 - FM 967 AT GARLIC CREEK EAST.dwg

Scale:	NOT TO SCALE
Copy:	CONSTRUCTION PLANS

Project No:	A641
Drawing:	1



Note: All conduit straps will be secured with stainless steel expansion anchor bolts sealed with concrete epoxy



Designed:	EEC
Drawn:	EEC
Checked:	MLR
Edit:	2-7-2018

Title:	50045 - FM 967 AT GARLIC CREEK EAST RISER PIPE DETAIL
Filepath:	P:\A641-City of BUDA TEXAS Flashers\AutoCAD\Construction Drawings\50045 - FM 967 at Garlic Creek East\50045 - FM 967 AT GARLIC CREEK EAST.dwg

Scale:	NOT TO SCALE
Copy:	CONSTRUCTION PLANS

Project No:	A641
Drawing:	2



Master Flasher

Conduit



Designed:	EEC
Drawn:	EEC
Checked:	MLR
Edit:	2-7-2018

Title:	50045 - FM 967 AT GARLIC CREEK EAST CONDUIT DETAIL
Filepath:	

Scale:	NOT TO SCALE
Copy:	CONSTRUCTION PLANS

Project No:	A641
Drawing:	3

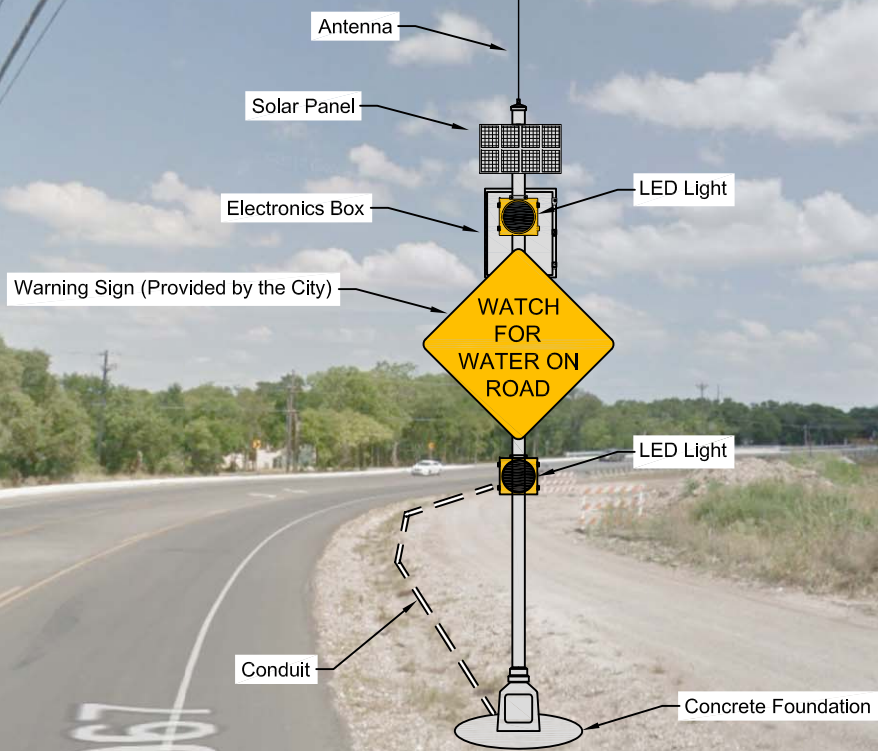



APPENDIX B.3
Bluff Street at Peach Street FEWS Construction Plans



Designed:	EEC
Drawn:	EEC
Checked:	MLR
Edit:	2-8-2018

Title:	50046 - BLUFF STREET AT PEACH STREET SITE AERIAL VIEW
Filepath:	P:\A641-City of BUDA TEXAS Flashers\AutoCAD\Construction Drawings\50046 - Bluff Creek at Peach Street\50046 - BLUFF STREET AT PEACH STREET.dwg

Scale:	NOT TO SCALE
Copy:	CONSTRUCTION PLANS

Project No:	A641
Drawing:	1

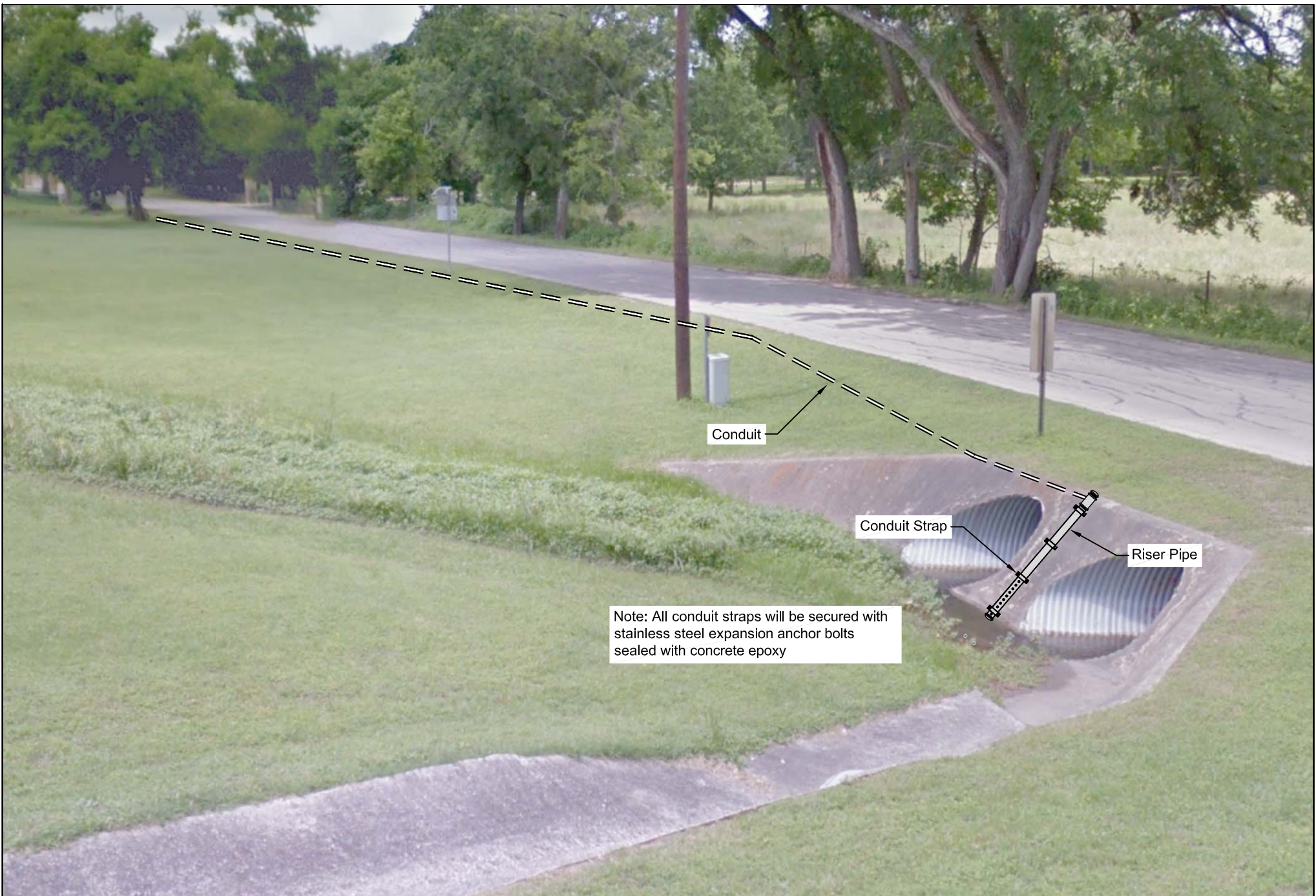

Designed: EEC	Title: 50046 - BLUFF STREET AT PEACH STREET RISER PIPE DETAIL	Scale: NOT TO SCALE	Project No: A641
Drawn: EEC		Copy: CONSTRUCTION PLANS	Drawing: 2
Checked: MLR			
Edit: 2-8-2018		Filepath: P:\A641-City of BUDA TEXAS Flashers\AutoCAD\Construction Drawings\50046 - Bluff Creek at Peach Street\50046 - BLUFF STREET AT PEACH STREET.dwg	



Conduit



Designed:	EEC
Drawn:	EEC
Checked:	MLR
Edit:	2-8-2018

Title:	50046 - BLUFF STREET AT PEACH STREET CONDUIT DETAIL
Filepath:	P:\A641-City of BUDA TEXAS Flashers\AutoCAD\Construction Drawings\50046 - Bluff Creek at Peach Street\50046 - BLUFF STREET AT PEACH STREET.dwg

Scale:	NOT TO SCALE
Copy:	CONSTRUCTION PLANS

Project No:	A641
Drawing:	3

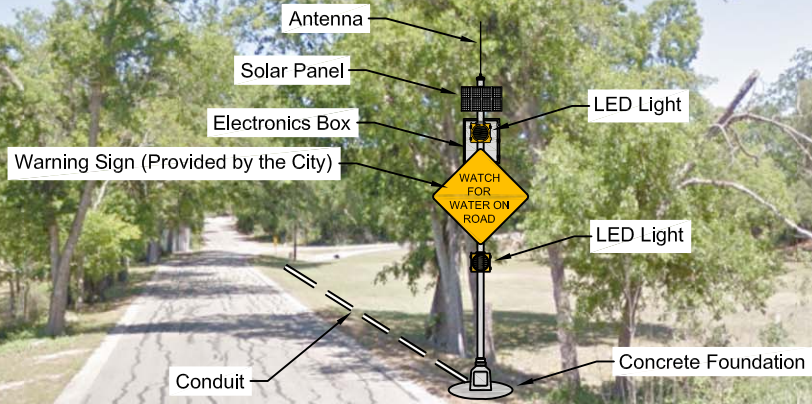





Google



Designed: EEC	Title: 50046 - BLUFF STREET AT PEACH STREET SLAVE 2 FLASHER DETAIL	Scale: NOT TO SCALE	Project No: A641
Drawn: EEC		Copy: CONSTRUCTION PLANS	Drawing: 6
Checked: MLR			
Edit: 2-8-2018		Filepath: P:\A641-City of BUDA TEXAS Flashers\AutoCAD\Construction Drawings\50046 - Bluff Creek at Peach Street\50046 - BLUFF STREET AT PEACH STREET.dwg	

Executive summary

The Texas Water Development Board (TWDB) offers grants to political subdivisions of the State of Texas for evaluation of structural and nonstructural solutions to flooding problems. Political subdivisions of the State of Texas with the legal authority to plan for and implement flood protection measures within their jurisdictional area and are members of the National Flood Insurance Program (NFIP) are eligible to apply. Grants for flood protection planning require a 50% local match of the total project cost.

Key performance provisions for a project performed under the TWDB Flood Protection Planning Program grant are as follows:

- Grant applicants must provide acceptable evidence of local matching funds on or before the date specified for negotiation and execution of a contract;
- Grant applicants must coordinate existing and planned flood protection activities in a watershed in a manner that avoids duplication of efforts;
- Any subcontracts for professional services for the grant applicant must be awarded in accordance with the Texas Government Code Chapter 2254, Professional and Consulting Services;
- All subcontracts must be approved in writing by the TWDB before being contracted or assigned; and
- Grant applicants must hold a minimum of three public meetings between the project participants, consultants, local entities, the TWDB, and the affected public to solicit comments on the content of the planning project, and to receive comments on the draft final project report.

In response to the TWDB Fiscal Year 2016 Request for Proposal for Flood Planning Projects, the City of Buda submitted a grant application for a proposed Flood Early Warning System (FEWS). On August 25, 2016, the TWDB authorized a Disaster Contingency Fund Flood Protection Grant for the City of Buda for this project.

The City of Buda Expansion of the Hays County, Texas, Flood Early Warning System Network within the Austin-Travis Lakes Planning Area project has increased community flood resilience through implementation of structural measures intended to reduce risks to persons and property. This project involved the construction of permanent FEWS installations at selected flood-prone locations on public roads within the City of Buda, Texas. The project has provided timely and effective information and enabled the community to more proactively respond to flood threats.

Acronyms

A	Amp
ALERT2	Automated Local Evaluation in Real Time; 2 nd generation
AGL	Above Ground Level
Ah	Amp-hour
AM	Amplitude Modulation
BNC	Bayonet Neill–Concelman
d/s	Downstream
ESC	Erosion and Sediment Control
FCC	Federal Communications Commission
FEMA	Federal Emergency Management Agency
FEWS	Flood Early Warning System
FM	Farm-to-Market
GPS	Global Positioning System
HMP	Hazard Mitigation Plan
LCRA	Lower Colorado River Authority
MHz	Megahertz
MUTCD	Manual of Uniform Traffic Control Devices
NFHL	National Flood Hazard Layer
NFIP	National Flood Insurance Program
NOAA	National Oceanic and Atmospheric Administration
PCB	Printed Circuit Board
PT	Pressure Transducer
RM	Ranch-to-Market
RX/TX	Receive and Transmit
SCADA	Supervisory Control and Data Acquisition
SFHA	Special Flood Hazard Area
SDI-12	Serial Digital Interface at 1200 baud
SMA	Sub-Miniature (version) A
TDMA	Time-Division Multiple Access
TWDB	Texas Water Development Board
u/s	Upstream
USGS	United States Geological Survey
VDC	Volts Direct Current
WSE	Water Surface Elevation

Table of contents

Executive summary.....	2
Acronyms.....	3
1 Background and introduction.....	5
2 Methodology.....	7
Project development.....	8
Project procurement.....	9
Project deployment.....	9
3 Results.....	16
4 Conclusions.....	17
5 Acknowledgements.....	18
6 References.....	19

APPENDIX A	City of Buda City Council Resolution No. 2016-R-11
APPENDIX B.1	RM 967 at Garlic Creek West FEWS Construction Plans
APPENDIX B.2	RM 967 at Garlic Creek East FEWS Construction Plans
APPENDIX B.3	Bluff Street at Peach Street FEWS Construction Plans
APPENDIX B.4	RM 967 at Bluff Street FEWS Construction Plans
APPENDIX B.5	Onion Creek Bridge FEWS Construction Plans
APPENDIX B.6	Cole Springs Road FEWS Construction Plans
APPENDIX C	FEWS Equipment Manuals
APPENDIX D	FCC Radio Station Authorization
APPENDIX E	TWDB Comments on Draft Report

1 Background and introduction

Riverine flooding is the result of persistent precipitation over a widespread area that results in a time-delayed water surface rise causing downstream (d/s) watercourses to overflow their banks. Flash flooding is typically the result of intense rainfall over a relatively small area in a short amount of time. Urban flooding is characterized by shallow concentrated and channelized surface water flow that rises and falls rapidly across properties with little or no advance warning.

The overall factors that affect flooding severity include the spatial distribution, intensity, and duration of a rainfall event over the receiving catchment; the carrying capacity of the receiving drainage course or stream network; the antecedent conditions to the rainfall event; and the ability of the ground surface and vegetation to hold precipitation. The extent of damage caused by urban flooding is related not just to the severity of the storm event, but also to the vulnerability of persons living and working in flood-prone areas. Flood resiliency efforts abate vulnerability and permit impacted individuals to prepare for and avoid flood threats.

The City of Buda experiences periodic riverine and frequent flash flooding. This flooding is a frequent hazard within the community that poses a threat to life and property, as was the case with the Halloween 2013, October 30, 2015, and May 27, 2016, flood events (all three declared Presidential Disasters) that severely affected Buda.

On October 31, 2013, record rainfall fell within the Onion Creek catchment, which then overtopped the Onion Creek Bridge on Ranch-to-Market (RM) 967. Barricades were in place at Old Black Colony Road and Cole Springs Road when it was obvious that roadway overtopping was inevitable. While multiple cars turned around, one driver chose to drive around the barricades and a swift water rescue was required to extract the driver. Old Black Colony Road and Cole Springs Road are closed on an average of three times a year due to rushing water. In 2016, Old Black Colony Road and Cole Springs Road were barricaded three times due to flash flooding. Other areas within the City of Buda that are prone to roadway overtopping and flash flooding are Bluff Street between Farm-to-Market (FM) 2770 and RM 967; the Garlic Creek culvert on RM 967; and the culvert upstream (u/s) of the Cullen Country Pond tributary on RM 967.

Even seasonal rain events of two inches per hour cause street flooding at Cole Springs Road and Old Black Colony Road. Depending on the amount of soil moisture present, three to four inches of rainfall over several hours will cause flooding at Bluff Street; four to five inches within a four-hour period will cause flooding at the Garlic Creek culvert on RM 967; and six to twelve inches of rain u/s of Onion Creek Bridge at RM 967 will cause flooding at the bridge.

Hazard mitigation is defined as "any action taken to reduce or eliminate the risk to human life and property from natural hazards", listed in 44 Code of Federal Regulations Subpart M, 206.401. The most recent Hays County Hazard Mitigation Plan Update includes flood warning systems as a hazard mitigation goal for the City of Buda. The FEWS project helps achieve that objective. The specific Hazard Mitigation Plan goal addressed is the "monitoring of precipitation, stream levels, and water rise at low water crossings at the designated project location 24 hours a day, 365 days a year." Further, the construction of FEWS at flood-prone locations in the City of Buda enhances the countywide FEWS. During a flood event, City and County staff and emergency management personnel are now able to work more closely for effective and timely community response during flood events.

A FEWS involves a combination of tools and processes embedded within the emergency management structures coordinated by local, county, state, and federal agencies. An effective FEWS requires four essential elements: a knowledge of the risk; an employment of applicable technical monitoring and warning infrastructure; a dissemination of appropriate warnings to at-risk individuals; and an aware public that is prepared to act. FEWS are increasingly considered to be an effective hazard mitigation tool and an integral component of disaster preparedness.

A properly designed and implemented FEWS can save lives and reduce property damage by increasing the time to prepare and respond to the threat of floods or flash floods. A reliable infrastructure for flood risk management allows authorities to respond effectively and therefore work to prevent loss of life.

2 Methodology

On June 7, 2016, the Buda City Council approved a resolution affirming the City of Buda's commitment to complete a grant project meeting the objectives of the TWDB Flood Protection Planning Program. Resolution No. 2016-R-11 is attached as Appendix A to this report. On August 25, 2016, the TWDB authorized a flood protection grant for a \$585,780 FEWS project for the City of Buda out of the Disaster Contingency Fund. The grant, which benefits the Onion Creek Watershed within the Austin-Travis Lakes Planning Area, supported the construction of permanent FEWS equipment along selected flood-prone public roads in the City of Buda. The TWDB share of total project costs is the lesser of \$292,890 or 50 percent of total project costs.

On January 27, 2017, the TWDB Executive Administrator executed a project contract with the City of Buda with a Project Completion Date of April 30, 2018. At the request of the City of Buda, the TWDB twice consented to extend the Project Completion Date. The Project Completion Date was ultimately extended to January 31, 2019.

The City of Buda was required to conduct public meetings in the interest of project participants, consultants, local entities, the TWDB, and other community stakeholders. The purpose of these meetings was to describe the project, and to solicit input and comments from the affected public. Public meetings were required to be conducted in accordance with the Texas Open Meetings Act and held upon agreement between the City of Buda and TWDB. The public meetings were required, at a minimum, at the commencement of the project, near the mid-point of the project, and upon completion of this report.

Ahead of each public meeting, a public meeting notice was issued through the City of Buda Public Information Office and published under official notices on the City of Buda's website by the City Clerk. Each official notice stated that "The project is being funded jointly by the City of Buda and the Texas Water Development Board, with project management services provided by the City of Buda."

The following public meetings were for the project:

- The first public meeting occurred during the Public Hearing portion of the Tuesday, March 7, 2017, Regular Buda City Council Meeting. Kara Denney of the TWDB attended and spoke at this public meeting.
- The second public meeting occurred during the Public Hearing portion of the Tuesday, May 1, 2018, Regular Buda City Council Meeting. Joshua Oyer of the TWDB attended and spoke at this public meeting.

- The third and final public meeting occurred during the Public Hearing portion of the Tuesday, January 19, 2019, Regular Buda City Council Meeting. Sara Husted of the TWDB attended and spoke at this public meeting.

After each narrative and visual presentation, an opportunity was provided to receive input from project stakeholders, regarding the City of Buda FEWS flood planning project. Public comments were solicited in both written and verbal form. Each of the public meeting presentations is archived at www.ci.buda.tx.us/390/Council-Board-Commission-Meetings---VIEW.

Project development

Fully automated signals were proposed for the following flood-prone locations:

Garlic Creek Culverts on RM 967

During a flood event, Garlic Creek overtops RM 967. Water rises over the top of the roadway due to undersized culverts and tailwater from the d/s channel. The average annual daily traffic for this crossing is 10,000 vehicles per day.

Bluff Street between RM 967 and FM 2770

During a flood event, a tributary to Onion Creek overtops Bluff Street. The average annual daily traffic for this roadway is 750 vehicles per day.

Onion Creek Bridge on RM 967

During a flood event, Onion Creek overtops RM 967. The average annual daily traffic for this bridge crossing is 11,400 vehicles per day.

Cole Springs Road at RM 967

During a flood event, Onion Creek overtops Cole Springs Roadway. The overtopped area is approximately one mile in length. The warning stations at the Cole Springs Road installation are controlled by the FEWS base station installed with the Onion Creek Bridge project. The average annual daily traffic for this roadway is 1,173 vehicles per day.

Main Street at Bradfield Park

During a flood event, a tributary to Onion Creek flowing through Bradfield Park overtops Main Street. The average annual daily traffic for this roadway is 10500 vehicles per day. (A warning system was not installed at this location. Under the 2014 Bond Proposition 3 – Streets, the City of Buda procured a professional service consultant to design an expansion of the Main Street culvert that will capture and convey the base flood event and eliminates overtopping of Main Street. Construction of the Main Street Improvements Project will begin in the Summer of 2019).

Each FEWS installation includes two automatic flashing warning signs, one located on either end of the roadway inundation area. The construction plans representing the as-built conditions for each of these installations are provided in Appendices B.1 through B.6 of this report.

Project procurement

Hays County has implemented several TWDB-funded projects involving FEWS installations. After both Hays County and the City of Buda were notified of TWDB Fiscal Year 2016 Disaster Contingency Fund Flood Protection Grant project award, Hays County invited City of Buda Public Works staff to participate in the evaluation of FEWS equipment vendor qualifications and selection. Because Hays County competitively bid the installation of the FEWS equipment in accordance with statutory provisions and included a cooperative purchasing clause, the City of Buda was able to use the same vendor selected by Hays County - Water & Earth Technologies (WET). The City of Buda benefitted from Hays County's Request for Proposal for the FEWS equipment and ensured that the City of Buda's equipment is fully compatible with the countywide FEWS.

The City of Buda executed a subcontract agreement with WET to procure and install the proposed low-water crossing warning system installations within the City of Buda. The form of contract with WET was approved by Hays County on December 20, 2016 and authorized by the Hays County Commissioners Court on January 23, 2017. A construction kick-off meeting was held with WET on February 8, 2018. The City of Buda issued a Notice-To-Proceed to WET on February 28, 2018.

Project deployment

The project involved the installation of new automated water surface elevation (WSE) sensors and traffic flashers at the selected public roadway low-water crossings identified in Figure 1.

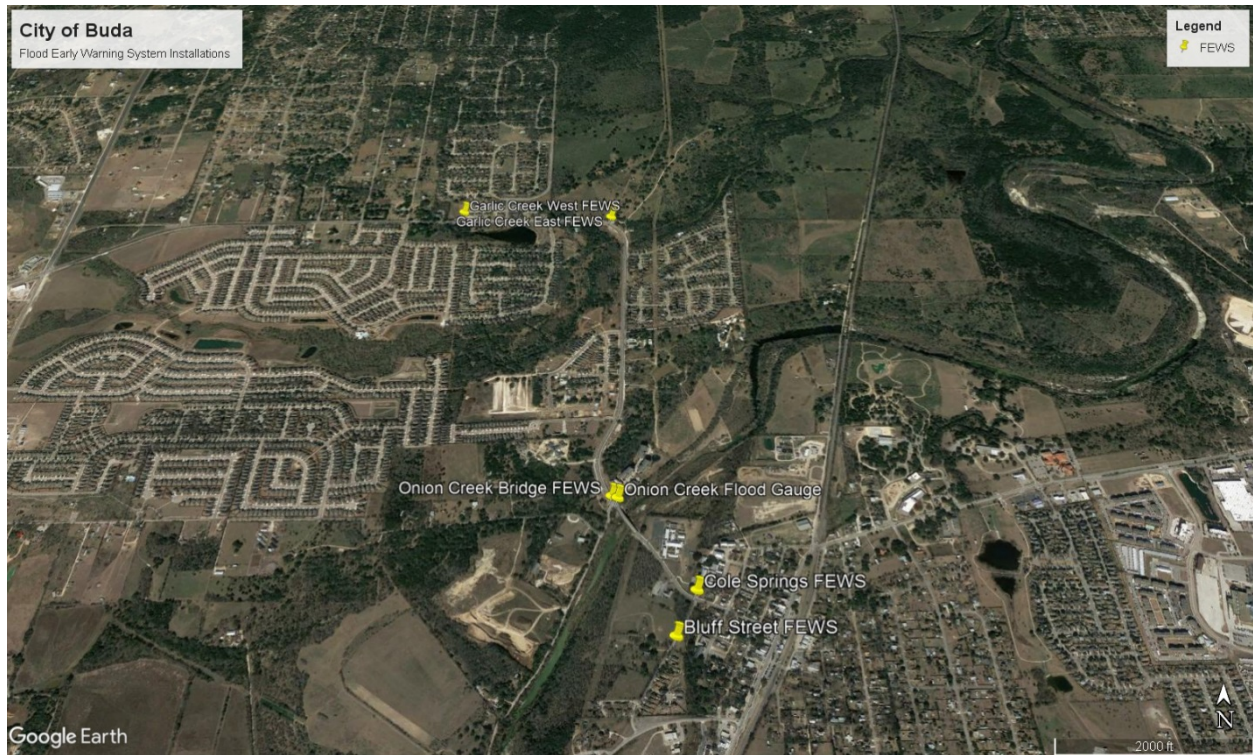

Figure 1. City of Buda FEWS Installations

The City of Buda FEWS installations transmit to the Hays County base station at the Hays County Government Center through a radio receiver/decoder through a relay station at the Buda Fire Station #3 located at Bluff Street and FM 2770/Jack C Hays Trail. The project FEWS were integrated into the existing Hays County time-division multiple access (TDMA) plan using the ALERT2 radio transmission protocol. The City of Buda has access to the station data in real time through a web application. The FEWS communicates via a Supervisory Control and Data Acquisition (SCADA) system and officials are automatically notified when the warning signs are activated. SCADA is a system for remote monitoring and control that operates with coded signals over communication channels.

WET was subcontracted on a turnkey basis to perform all necessary field tasks for the installation of the new flasher stations. Major subcontract project tasks included permitting, Federal Communications Commission (FCC) radio licensing, construction drawing preparation, database management, shop fabrication, system programming, field installation, testing, and field project management. WET also fabricated the flasher assemblies and foundations with the approval of the City of Buda.

Master gauging stations and remote warning stations

Each monitoring site includes a pressure transducer (PT) stream gauge that automatically activates flashing lights on two emergency roadway flashers. The flashing lights are mounted on traffic poles on each side of the low water crossing (two poles per low water crossing, visible to drivers approaching from both directions).

One pole holds the master controller; the other holds a slave controller. The master and slave controllers share data and controls through a 900 MHz radio link. The master controller receives water level data from the PT and automatically turns on flashing lights when the water level reaches a predefined limit. The lights turn off when the level drops to a preset limit or a time limit expires. A licensed 170 MHz ALERT2 radio telemetry system transmits the master and slave controller data to a Hays County FEWS network base station (either directly to the primary base station or via a distributed base station) and receives control commands from the base station.

WET procured network components and equipment for the project from HydroLynx Systems, Inc. Installation manuals for the listed equipment are included as Appendix C to this report. The installation and maintenance of network hardware, and training related to the station equipment was provided by WET.

The following master equipment has been installed at the RM 967 Onion Creek Bridge/Cole Springs Road, the RM 967 Garlic Greek culvert, and the Bluff Street flood gauging locations:

- Three (3) flashers in 10-foot standpipe with grounding tab
- Three (3) packaged repeaters (canister with 1 BNC, 1 SMA connectors, SDI-12 water level sensor and rain gauge inputs; Ritron ALERT2 radio RX/TX Frequency 171.100; ALERT2 decoder/ demodulator; ALERT2 encoder PCB for repeater; & ALERT2 transmit cables)
- Three (3) AM antenna mast assemblies and omnidirectional antenna with antenna cables and connectors
- Three (3) GPS antenna with lightning protection
- Three (3) gel cell batteries (22 Ah, 12 VDC)
- Three (3) rain gauges
- Three (3) pressure transducers with cabling
- Three (3) lifting ropes

The following equipment has been installed at the RM 967 Onion Creek Bridge flood gauging location:

- SDI-12 radar water level sensor

The following equipment has been installed to support the (1) RM 967 Onion Creek Bridge/Cole Springs Road, the (2) RM 967 Garlic Creek Culvert, and the (3) Bluff Street flood gauging locations:

- Eleven (11) pole-mounted slave flashers with 900 MHz spread spectrum radio with antenna, cabling, and lightening protection
- Three (3) relays (10 A)

Installation schedule

The detailed equipment installation schedule for the project was as follows (all dates are 2018):

Site 50042 - Onion Creek Bridge at RM 967

Installation of standpipe, conduit & riser: March 29th - 30th

Date of Completion: April 2nd

Site 50043 - Cole Springs Road at Old Black Colony Road

Installation of conduit: March 30th & 31st

Installation of riser pipe: March 31st

Installation of master pole foundation: April 16th

Installation of slave pole foundation: April 17th

Date of completion: June 21st

Site 50044 - RM 967 at Garlic Creek West

Installation of slave pole foundation: April 27th

Installation of master pole foundation: April 28th

Installation of conduit and riser pipe: April 29th

Date of completion: June 13th

Site 50045 - RM 967 at Garlic Creek East

Installation of slave pole foundation: April 18th

Installation of master pole foundation: April 25th

Installation of conduit: April 26th

Installation of riser pipe: April 29th

Date of completion: June 26th

Site 50046 - Bluff Street @ Peach Street

Installation of slave 1: May 23rd

Installation of slave 2: May 26th

Installation of riser: July 12th

Installation of master: July 12th

Date of completion: July 31st

Site 50047 - RM 967 at Bluff Street

Installation of master: May 23rd

Installation of slave 1: May 24th

Installation of slave 2: June 7th

Installation of riser: June 6th

Date of completion: July 31st

Basic warranty

The equipment furnished and installed for this project was field tested to perform according to the manufacturer's specifications. The equipment is state-of-the-art with readily available replacement parts. The HydroLynx Systems warrants that the installed products are free from defects in material and workmanship under normal use and service for a period of one year from the date of shipment from the factory.

Similarly, the installation workmanship at all sites is warranted by WET for a period of one year from the date of installation, except in the case of damage outside of WET's control, including vandalism or an automobile accident impacting a station. In such instances, the City of Buda is responsible for the replacement of damaged components and the installation and calibration of the replaced equipment.

Barricades, signs, and traffic control devices

Following completion of installing all the flashers, the City of Buda ordered and provided all required Manual of Uniform Traffic Control Devices (MUTCD) conformant traffic warning signage to the WET field crew. The sign text for the 36-inch by 36-inch dimension signs conforms to other FEWS installations completed by WET for Hays County. The station signage is as follows:

- Cole Springs Road at Old Black Colony Road – 2 signs
- RM 967 at Garlic Creek West – 2 signs
- RM 967 at Garlic Creek East – 2 signs
- Bluff Street at Peach Street – 3 signs
- RM 967 at Bluff Street – 2 signs

Final stabilization

There were no regulatory requirements for erosion and sediment control (ESC) measures for this project based upon the extremely limited extent of land disturbance associated with this construction activity. All work was completed in public right-of-way. WET exercised good

housekeeping and pollution prevention measures during performance of the work. All FEWS installation sites have been cleaned up and stabilized.

Data management

The City of Buda obtained an FCC radio license for all flasher sites. Evidence of licensure is attached as Appendix D to this report. The City of Buda FEWS installations interface with the communication system/software maintained and operated by the Hays County Office of Emergency Management. The City of Buda coordinated data standards and collection protocols to match existing efforts to ensure consistency and compatibility with existing countywide flood warning and forecasting efforts.

Data are reported to the Hays Informed website hosted by the Hays County Office of Emergency Management. The Hays County WETMap application is a publicly accessible website (<http://novastar-main.co.hays.tx.us/WETMapV3/HaysCounty/public/WETMap.html>) for use in providing information on flood conditions. A screen capture from this application is provided as Figure 2 to the report.

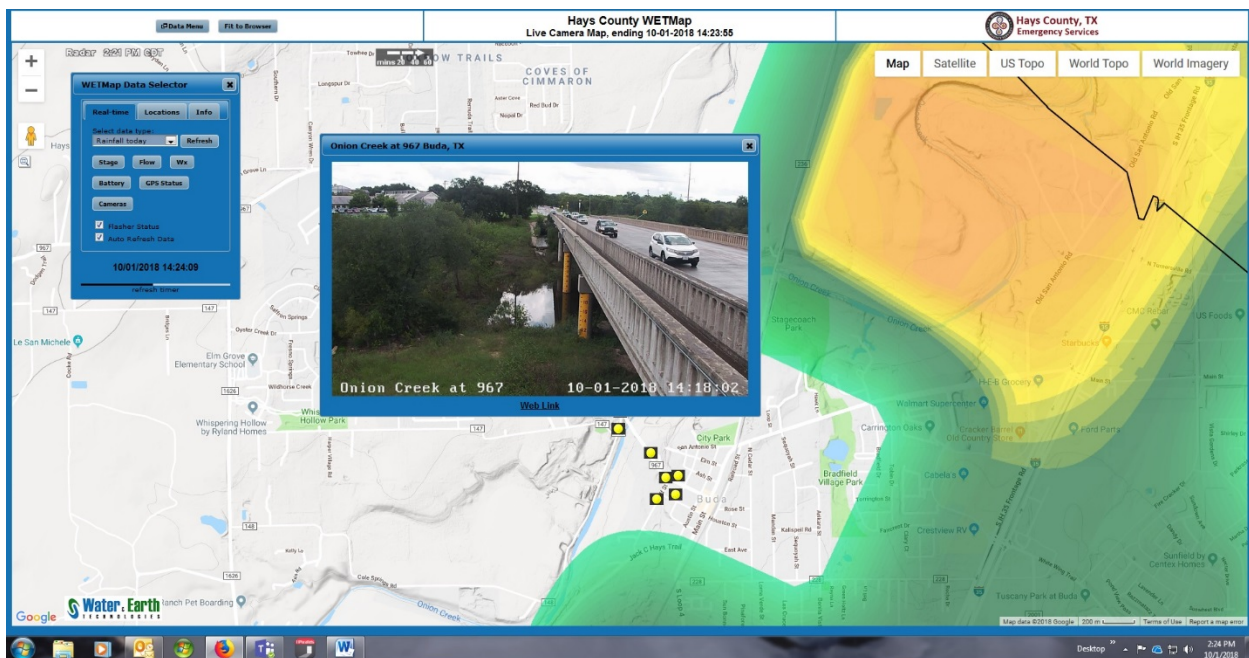

Figure 2. Hays County WETMap

Data collected as part of this project are made available so long as the equipment remains operational.

Future tasks

Following submittal of the final report for the project, the following tasks are planned:

- WET is continuing to evaluate improving signal redundancy of the Hays County FEWS network with the new Buda FEWS stations so that each station is better able to be received at multiple base stations. To accomplish this task, the receiver/decoder (base station) at the Buda Fire Station on FM 2770 may ultimately be relocated to the City of Buda's Beacon Hill potable water distribution system elevated storage tank on RM 967 1-½ miles west of FM 1626.
- The City of Buda has negotiated an annual maintenance agreement with WET to start after the basic warranty period expires in April 2019.

3 Results

The City of Buda's submitted a draft project report to the TWDB on January 31, 2019. The TWDB provided review comments on the draft report, which are attached as Appendix E to this report and have been incorporated into this final report.

The City of Buda followed industry standards and best practices to ensure that the Flood Early Warning System's installation was performed properly and in full working order well ahead of the project deadline. The City of Buda secured a proposal from WET for ongoing maintenance to be performed regularly so that the FEWS equipment is kept in good working order. The City of Buda has fully accepted the equipment for its intended use and is liable for any damage to and loss of such equipment if such damage or loss is due to negligence or deliberate misuse. The FEWS equipment is covered by the City of Buda's property liability insurance coverage provided through the Texas Municipal League. The City of Buda will keep and maintain records relating to the necessity for and the use of the FEWS equipment. The City of Buda values the public new assets and understands that the FEWS equipment must be maintained for a minimum of a five-year period.

Because the City of Buda has sought to avoid damage or destruction of the expensive FEWS components, either by the hand of man or natural events, WET made every effort to design and construct the monitoring installations so that they are robust. However, because the equipment is located within floodplains, WET cannot guarantee that there will be no damage in the aftermath of a large flood event; however, WET has a proven track record for stations surviving flood events (including in Hays County) as long as bridges and roads in the stream gauge vicinity do not wash out and the channel does not significantly re-align.

WET has assured the City of Buda that all equipment provided for this project has a history of successful operating experience in similar installations and was in a new and unused condition upon installation. The equipment is state-of-the-art and readily available replacement parts are available. All equipment used for this project was approved by the City of Buda prior to installation.

4 Conclusions

The project has yielded the following benefits:

- The early flood detection system has improved safety in flood prone areas of the City of Buda;
- The installed equipment is compatible with, and has enhanced, Hays County's FEWS network; and
- The project is providing flood monitoring data that support flood mitigation efforts.

5 Acknowledgements

The City of Buda wishes to acknowledge the following organizations and individuals who have assisted in the completion of the City of Buda FEWS project:

Texas Water Development Board staff, including State Flood Grants Coordinator Ivan Ortiz and his current and past National Flood Insurance Program and Flood Outreach associates Kara Denney, Joshua Oyer, and Sara Husted, provided valuable guidance throughout the project.

Justin McInnis, Assistant Director & Assistant Emergency Management Coordinator, with the Hays County Office of Emergency Services.

Mike Beggs and Brian Lillibridge with the City of Buda Public Works Department.

Markus Ritsch, Eric Carlson, and Rob Niedenzu with Water & Earth Technologies, Inc.

The Buda City Council, without whose support on behalf of the citizens of Buda this project would not have been possible.

6 References

Ward, Jeffrey S. & Associates, 2017, “Hays County Hazard Mitigation Plan”.

National Oceanic and Atmospheric Administration, et al., 2012 “National Weather Service Flood Warning Systems Manual”.