

**Eastern Parker County**

**Regional Wastewater Facilities Plan**

**Prepared for:**

**City of Aledo**

**Town of Annetta**

**Town of Annetta North**

**Town of Annetta South**

**City of Fort Worth**

**City of Hudson Oaks**

**City of Weatherford**

**City of Willow Park**

**Tarrant Regional Water District**

**Parker County Utility District Number One**

**July 31, 2007**

**Prepared by:**

**Alan Plummer Associates, Inc.**

**1320 South University Drive, Suite 300**

**Fort Worth, Texas 76107**

# Table of Contents

<b>CHAPTER 1 EXECUTIVE SUMMARY .....</b>	<b>1-1</b>
1.1 BACKGROUND .....	1-2
1.1.1 <i>Regional Wastewater Facilities Planning Area</i> .....	1-2
1.1.2 <i>Existing Wastewater Treatment</i> .....	1-2
1.1.3 <i>Previous Planning Efforts</i> .....	1-4
1.1.4 <i>Current Planning</i> .....	1-4
1.2 POPULATION AND WASTEWATER FLOW PROJECTIONS .....	1-4
1.3 POTENTIAL REGIONAL WASTEWATER TREATMENT PLANT SITES .....	1-4
1.4 CONCEPTUAL DESIGN FOR REGIONAL COLLECTION SYSTEM .....	1-7
1.5 RECOMMENDED EFFLUENT WATER QUALITY .....	1-7
1.6 CONCEPTUAL DESIGN FOR REGIONAL WASTEWATER TREATMENT FACILITIES .....	1-9
1.6.1 <i>Weatherford WWTP</i> .....	1-10
1.6.2 <i>Willow Park WWTP</i> .....	1-12
1.6.3 <i>Aledo WWTP</i> .....	1-12
1.6.4 <i>Deer Creek Waterworks WWTP</i> .....	1-12
1.6.5 <i>Summary</i> .....	1-13
1.7 POTENTIAL RECLAIMED WATER CUSTOMERS .....	1-14
1.8 OPINION OF PROBABLE CAPITAL COST .....	1-14
1.9 IMPLEMENTATION PLAN .....	1-14
1.9.1 <i>Actions by Phase</i> .....	1-14
1.9.2 <i>Actions During All Phases</i> .....	1-17
1.9.3 <i>Project Timing</i> .....	1-17
<b>CHAPTER 2 INTRODUCTION .....</b>	<b>2-1</b>
2.1 BACKGROUND .....	2-1
2.2 REGIONAL WASTEWATER FACILITIES PLANNING AREA .....	2-2
2.2.1 <i>Location</i> .....	2-2
2.2.2 <i>Political Subdivisions</i> .....	2-2
2.3 EXISTING WASTEWATER TREATMENT .....	2-7
2.3.1 <i>Wastewater Treatment Plants</i> .....	2-7
2.3.2 <i>Septic Systems</i> .....	2-11
2.4 PREVIOUS PLANNING EFFORTS .....	2-12
2.4.1 <i>1988 TCWCID #1 Regional Facility Planning Study</i> .....	2-12
2.4.2 <i>1988 TRA Facilities Plan</i> .....	2-14
2.4.3 <i>2003 Weatherford Planning</i> .....	2-16

2.4.4 2004 BRA and TRWD Regional Wastewater Service Study .....	2-16
2.4.5 Scenario PWW-2.....	2-18
2.4.6 2004 Fort Worth Planning .....	2-18
2.5 CURRENT PLANNING .....	2-18
<b>CHAPTER 3 POPULATION AND WASTEWATER FLOW PROJECTIONS .....</b>	<b>3-1</b>
3.1 PROJECTED POPULATION.....	3-1
3.1.1 By City/CCN .....	3-1
3.1.2 By Sewershed .....	3-2
3.2 PROJECTED ANNUAL AVERAGE PER CAPITA WASTEWATER FLOW .....	3-4
3.2.1 Historical Annual Average Per Capita Wastewater Flow .....	3-4
3.2.2 Projected Annual Average Per Capita Wastewater Flow .....	3-6
3.3 PROJECTED ANNUAL AVERAGE WASTEWATER FLOW .....	3-7
<b>CHAPTER 4 SITE SELECTION FOR ANALYSIS OF REGIONAL WASTEWATER TREATMENT FACILITIES.....</b>	<b>4-1</b>
4.1 CENTER POINT WWTP SITE .....	4-1
4.2 SOUTH WILLOW PARK WWTP SITE.....	4-1
4.3 CONFLUENCE WWTP SITE .....	4-1
4.4 CLEAR FORK WWTP SITE .....	4-3
<b>CHAPTER 5 CONCEPTUAL DESIGN FOR REGIONAL COLLECTION SYSTEM.....</b>	<b>5-1</b>
5.1 PRELIMINARY REGIONAL COLLECTION SYSTEMS.....	5-1
5.2 ANALYSIS OF PRELIMINARY REGIONAL COLLECTION SYSTEMS.....	5-5
5.2.1 Evaluation of a Single Configuration.....	5-5
5.2.2 Comparison of System Configurations .....	5-7
5.2.3 Identification of the Lowest-Cost 2030 Configuration .....	5-7
5.2.4 Alternative Configurations .....	5-8
5.2.5 Target 2030 Configuration .....	5-12
5.2.6 Sensitivity Analysis.....	5-13
5.3 IMPLEMENTATION OF A REGIONAL COLLECTION SYSTEM.....	5-13
5.3.1 Summary.....	5-13
5.3.2 Potential for Interaction with Proposed Mary's Creek WRC .....	5-14
<b>CHAPTER 6 PROJECTED EFFLUENT WATER QUALITY REQUIREMENTS .....</b>	<b>6-1</b>
6.1 WATER QUALITY ISSUES .....	6-1
6.1.1 303(d) List .....	6-1
6.1.2 Other Published Concerns.....	6-3
6.1.3 Reclaimed Water Quantity Issues.....	6-4

6.2 MODELING PROJECTIONS.....	6-5
6.2.1 Dissolved Oxygen .....	6-6
6.2.2 Nutrients.....	6-9
<b>CHAPTER 7 CONCEPTUAL DESIGN FOR REGIONAL WASTEWATER TREATMENT FACILITIES..</b>	<b>7-1</b>
7.1 REQUIRED TREATMENT CAPACITY .....	7-1
7.2 RAW WASTEWATER QUALITY .....	7-1
7.3 RECOMMENDED TREATMENT PROCESSES AND PHASING .....	7-2
7.3.1 Influent Lift Station .....	7-3
7.3.2 Fine Screens .....	7-3
7.3.3 Vortex Grit Concentrators .....	7-7
7.3.4 Aeration Basins .....	7-7
7.3.5 Final Clarifiers .....	7-7
7.3.6 Filters.....	7-8
7.3.7 Ultraviolet Disinfection and Discharge .....	7-8
7.3.8 Solids Handling .....	7-8
7.3.9 Odor Control.....	7-9
7.3.10 Other .....	7-9
7.4 OTHER WASTEWATER TREATMENT PLANTS IN THE PLANNING AREA.....	7-9
7.4.1 Weatherford WWTP .....	7-9
7.4.2 Willow Park WWTP.....	7-10
7.4.3 Aledo WWTP.....	7-11
7.4.4 Deer Creek Waterworks WWTP .....	7-12
7.4.5 Summary.....	7-13
<b>CHAPTER 8 POTENTIAL RECLAIMED WATER CUSTOMERS .....</b>	<b>8-1</b>
8.1 REQUIREMENTS FOR THE USE OF RECLAIMED WATER .....	8-1
8.1.1 Notification of the TCEQ and Authorization .....	8-1
8.1.2 General Requirements .....	8-1
8.1.3 Quality Standards.....	8-2
8.1.4 Specific Uses .....	8-3
8.1.5 Other Requirements.....	8-3
8.2 POTENTIAL RECLAIMED WATER CUSTOMERS .....	8-3
8.2.1 Potential Direct Reclaimed Water Customers.....	8-4
8.2.2 Potential Indirect Reclaimed Water Customers .....	8-5
<b>CHAPTER 9 OPINIONS OF PROBABLE COST .....</b>	<b>9-1</b>
9.1 OPINION OF PROBABLE CAPITAL COST .....	9-1
9.2 OPINION OF PROBABLE ANNUAL COST.....	9-3

9.3 OPINION OF PROBABLE UNIT COST.....	9-4
<b>CHAPTER 10 IMPLEMENTATION PLAN .....</b>	<b>10-1</b>
10.1 PHASE 1 .....	10-1
10.1.1 Participants' Committee .....	10-1
10.1.2 Identify Regional Wastewater Service Provider.....	10-1
10.1.3 Negotiate Service Agreements with Participants.....	10-1
10.1.4 Plan and Construct Local Collection Systems .....	10-4
10.1.5 Design Phase 1 Facilities.....	10-4
10.1.6 Obtain Financing.....	10-4
10.1.7 Acquire Property for Clear Fork WWTP.....	10-5
10.1.8 Permit Clear Fork WWTP.....	10-5
10.1.9 Permit Wastewater Conveyance Facilities.....	10-5
10.1.10 Construct Phase 1 Facilities .....	10-6
10.1.11 Retire Aledo WWTP.....	10-6
10.2 PHASE 2 .....	10-6
10.2.1 Reevaluate the Potential for a South Willow Park WWTP to Serve Phase 3 Customers ....	10-6
10.2.2 Plan and Construct Local Collection Systems for Phase 2.....	10-7
10.2.3 Design Phase 2 Facilities.....	10-7
10.2.4 Construct Phase 2 Facilities .....	10-7
10.2.5 Retire Deer Creek Waterworks WWTP.....	10-7
10.3 PHASE 3 .....	10-7
10.3.1 Plan and Construct Local Collection Systems .....	10-7
10.3.2 Design Phase 3 Facilities.....	10-8
10.3.3 Construct Phase 3 Facilities .....	10-8
10.3.4 Retire Willow Park WWTP .....	10-8
10.4 ALL PHASES .....	10-8
10.5 PROJECT TIMING .....	10-8
<b>CHAPTER 11 REFERENCES .....</b>	<b>11-1</b>

- List of Tables
- List of Figures
- List of Abbreviations
- List of Appendices

# List of Tables

Table 1-1 Projected Population by City/CCN.....	1-5
Table 1-2 Projected Annual Average Wastewater Flow by City/CCN (mgd) .....	1-5
Table 1-3 2030 Projected Treated Effluent Water Quality Requirements (mg/l).....	1-9
Table 1-4 Clear Fork WWTP Phases and Capacities .....	1-10
Table 1-5 Opinion of Probable Capital Cost for Eastern Parker County Regional Wastewater Facilities (2007 Dollars).....	1-15
Table 2-1 Existing Wastewater Treatment in the Planning Area .....	2-8
Table 2-2 Recent Wastewater Flow as a Percentage of Existing WWTP Treatment Capacity.....	2-10
Table 2-3 Average Monthly Wastewater Bills in the Planning Area .....	2-11
Table 3-1 Projected Population by City/CCN.....	3-2
Table 3-2 Projected Population by Sewershed.....	3-5
Table 3-3 Estimated Historical and Projected Annual Average Per Capita Wastewater Flows (gpcd) .....	3-6
Table 3-4 Projected Annual Average Wastewater Flow by City/CCN (mgd) .....	3-8
Table 3-5 Projected Annual Average Wastewater Flow by City and Sewershed (mgd) .....	3-9
Table 5-1 Potential Wastewater Treatment Locations by Sewershed.....	5-6
Table 5-2 Projected 2030 Cost Changes if Individual WWTPs Remain in Service .....	5-10
Table 6-1 2030 Annual Average Flowrates for QUAL-TX Analysis (mgd).....	6-7
Table 6-2 2030 Projected Treated Effluent Water Quality Requirements (mg/l).....	6-7
Table 7-1 Clear Fork WWTP Phases and Capacities .....	7-1
Table 7-2 Clear Fork WWTP Major Equipment by Phase.....	7-6
Table 8-1 Quality Standards for Using Reclaimed Water <sup>bb</sup> .....	8-2
Table 8-2 Projected Percentage of Parker County Groundwater Use for Barnett Shale Gas Wells <sup>dd</sup> .....	8-5
Table 9-1 Opinion of Probable Capital Cost for Eastern Parker County Regional Wastewater Facilities (2007 Dollars).....	9-2

# List of Figures

Figure 1-1 Regional Wastewater Facilities Planning Area .....	1-3
Figure 1-2 WWTP SITES Selected for Further Analysis .....	1-6
Figure 1-3 Recommended Phasing of the Regional Collection System .....	1-8
Figure 1-4 Clear Fork WWTP Treatment Process Schematic.....	1-11
Figure 1-5 Opinion of Probable Unit Cost for Eastern Parker County Regional Wastewater System (2007 Dollars).....	1-16
Figure 2-1 Regional Wastewater Facilities Planning Area Location Map .....	2-3
Figure 2-2 Regional Wastewater Facilities Planning Area .....	2-4
Figure 2-3 Sewer CCNs in the Planning Area .....	2-6
Figure 2-4 Recommendations of the 1988 TCWCID #1 Regional Facility Planning Study.....	2-13
Figure 2-5 Recommendations of the 1988 TRA Facilities Plan.....	2-15
Figure 2-6 Recommendations of the 2004 BRA and TRWD Regional Wastewater Service Study, Scenario PWW-1 .....	2-17
Figure 2-7 Recommendations of the 2004 BRA and TRWD Regional Wastewater Service Study, Scenario PWW-2 .....	2-19
Figure 2-8 Potential Mary’s Creek WRC Location Map .....	2-20
Figure 3-1 Planning Area Sewersheds.....	3-3
Figure 4-1 WWTP Sites Selected for Further Analysis .....	4-2
Figure 5-1 Primary Wastewater Collection Points .....	5-2
Figure 5-2 Potential Regional Interceptor Routes.....	5-3
Figure 5-3 Location of Existing Interceptors and Force Mains .....	5-4
Figure 5-4 Lowest-Cost 2030 Configuration .....	5-9
Figure 5-5 Alternative A 2030 Configuration.....	5-11
Figure 5-6 Recommended Phasing of the Regional Collection System.....	5-15
Figure 6-1 Clear Fork Trinity River 303(d) Listing.....	6-2

Figure 6-2 Potential 2020 Reclaimed Water Blend Frequency for Benbrook Lake ..... 6-5

Figure 6-3 Potential 2020 Reclaimed Water Residence Time Frequency for Benbrook Lake .. 6-6

Figure 6-4 Projected Dissolved Oxygen Concentrations, Summer Low-Flow Conditions ..... 6-8

Figure 6-5 Projected Lake Benbrook Response to Additional Nutrient Loading..... 6-10

Figure 7-1 Clear Fork WWTP Projected Annual Average Flow and Capacity ..... 7-2

Figure 7-2 Clear Fork WWTP Treatment Process Schematic..... 7-4

Figure 7-3 Example Site Plan Clear Fork WWTP ..... 7-5

Figure 7-4 Weatherford WWTP Projected Annual Average Flow and Capacity ..... 7-10

Figure 7-5 Willow Park WWTP Projected Annual Average Flow and Capacity ..... 7-11

Figure 7-6 Aledo WWTP Projected Annual Average Flow and Capacity ..... 7-12

Figure 7-7 Deer Creek Waterworks WWTP Projected Annual Average Flow and Capacity... 7-13

Figure 9-1 Opinion of Probable Annual Cost for Eastern Parker County Regional Wastewater Facilities (2007 Dollars)..... 9-4

Figure 9-2 Opinion of Probable Unit Cost for Eastern Parker County Regional Wastewater System (2007 Dollars)..... 9-5

Figure 10-1 Regional Wastewater Facilities Implementation Schedule ..... 10-2



## List of Abbreviations

APAI	Alan Plummer Associates, Inc.
BOD	Biochemical Oxygen Demand
BRA	Brazos River Authority
CBOD	Carbonaceous Biochemical Oxygen Demand
CCN	Certificate of Convenience and Necessity
CFU	Colony-Forming Units
EPA	U.S. Environmental Protection Agency
ETJ	Extraterritorial Jurisdiction
ft	Feet
ft <sup>2</sup>	Square Feet
gal	Gallons
gpcd	Gallons per Capita per Day
hp	Horsepower
in	Inches
kgal	Thousand Gallons
m	Meters
mg/l	Milligrams per Liter
µg/l	Micrograms per Liter
mgd	Million Gallons per Day
NCTCOG	North Central Texas Council of Governments
NTU	Nephelometric turbidity units
O&M	Operation and Maintenance
PCUD	Parker County Utility District No. 1
RAS	Return Activated Sludge
SWD	Side Water Depth
TCEQ	Texas Commission on Environmental Quality
TCWCID #1	Tarrant County Water Control and Improvement District No. 1
TMDL	Total Maximum Daily Load
TRA	Trinity River Authority
TRWD	Tarrant Regional Water District

TSS	Total Suspended Solids
TSWQS	Texas Surface Water Quality Standards
TWDB	Texas Water Development Board
UV	Ultraviolet
WAS	Waste Activated Sludge
WRC	Water Recycling Center
WTP	Water Treatment Plant
WWTP	Wastewater Treatment Plant

# List of Appendices

Appendix A Population Projections

Appendix B General Cost Guidelines

Appendix C Regional Collection System Details

Appendix D Detailed Opinions of Probable Annual Cost

Appendix E Summary of Public Meetings

Appendix F Texas Water Development Board Comments

## **CHAPTER 1**

### **EXECUTIVE SUMMARY**

Eastern Parker County is expected to experience rapid growth in the coming years. However, much of the area depends on individual septic systems for wastewater treatment. The cities in eastern Parker County have expressed interest in the feasibility of regional wastewater treatment facilities. Regionalization of wastewater treatment in eastern Parker County could:

- Provide additional treatment capacity to meet projected growth,
- Reduce reliance on septic systems,
- Protect the quality of groundwater and surface water (both of which are drinking water sources) in the Clear Fork Trinity River watershed,
- Reduce wastewater treatment costs through economies of scale,
- Provide updated wastewater treatment technology,
- Provide greater access to capital funding, and
- Prevent proliferation of numerous, small utilities.

The following political subdivisions (the Participants) participated in development of the Eastern Parker County Regional Wastewater Facilities Plan:

- City of Aledo
- Town of Annetta
- Town of Annetta North
- Town of Annetta South
- City of Fort Worth
- City of Hudson Oaks
- Parker County Utility District No. 1 (PCUD)
- Tarrant Regional Water District (TRWD)
- City of Weatherford
- City of Willow Park

The following sections summarize background information about wastewater planning in the region (Section 1.1), population and wastewater flow projections (Section 1.2), potential regional wastewater treatment plant sites (Section 1.3), a conceptual design for a regional wastewater collection system (Section 1.4), recommended effluent water quality (Section 1.5), a conceptual design for regional wastewater treatment facilities (Section 1.6), potential reclaimed water customers (Section 1.7), an opinion of probable capital cost (Section 1.8), and an

implementation plan for regional wastewater treatment (Section 1.9).

## **1.1 BACKGROUND**

This report details an implementation plan for developing regional wastewater facilities in eastern Parker County. The following sections describe the regional wastewater facilities planning area, review existing wastewater treatment facilities in the regional planning area, summarize previous regional wastewater treatment plans, and discuss the current planning effort.

### **1.1.1 Regional Wastewater Facilities Planning Area**

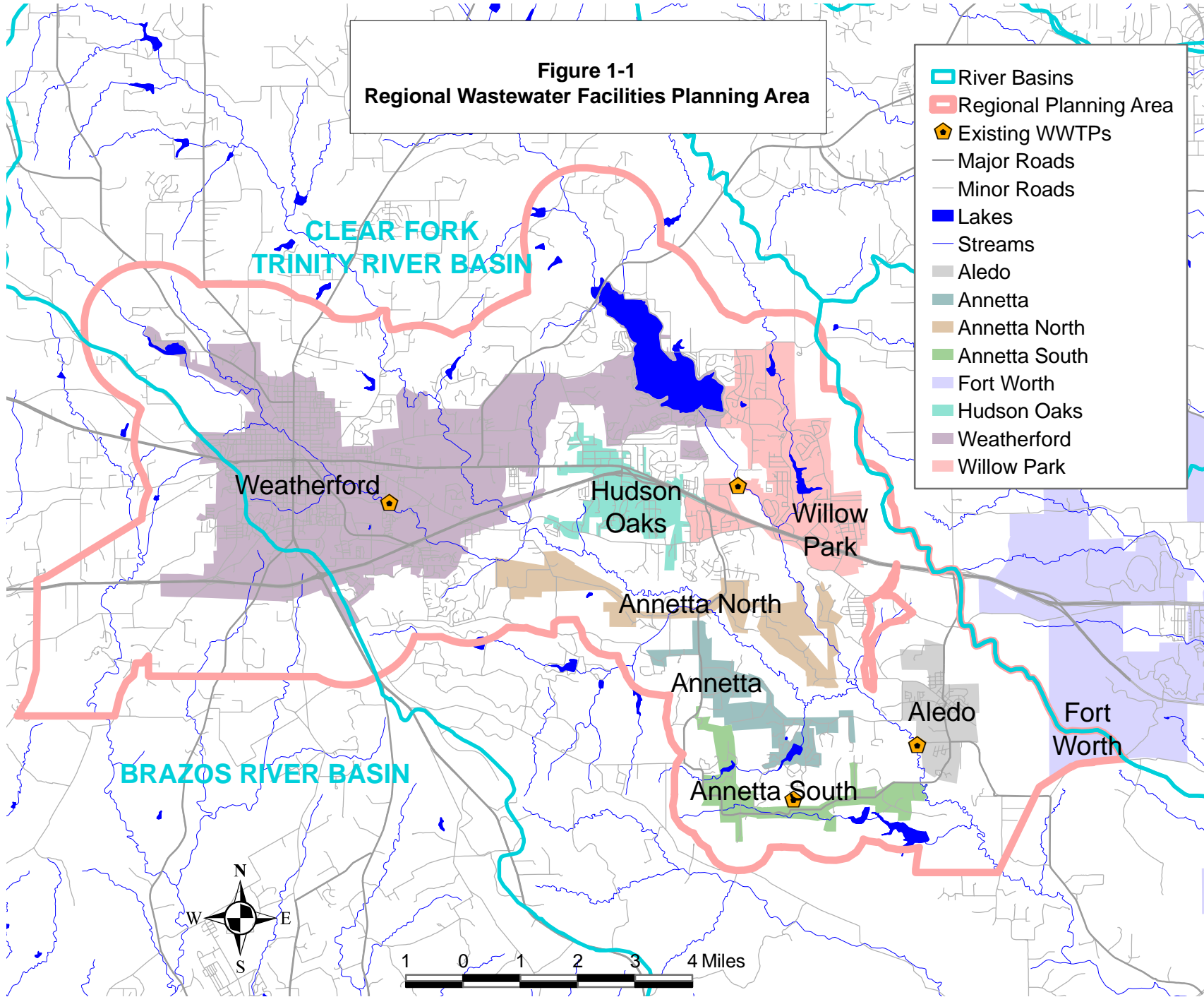
The regional wastewater facilities planning area (the Planning Area) comprises a large portion of eastern Parker County, including numerous political subdivisions (Figure 1-1). The Planning Area includes approximately 74,500 acres in eastern Parker County, located almost entirely within the Clear Fork Trinity River basin. A small portion of Weatherford's city limits, Certificate of Convenience and Necessity (CCN) service area, and extraterritorial jurisdiction (ETJ) is located in the Brazos River Basin, and a small portion of Willow Park's ETJ is located within the Trinity River Basin.

### **1.1.2 Existing Wastewater Treatment**

Wastewater generated in Aledo and Weatherford and in a limited portion of Willow Park is collected and transported to city-owned wastewater treatment plants (WWTPs). Wastewater generated in the commercial area of Hudson Oaks is pumped to the Weatherford WWTP for treatment. In addition, wastewater generated within the Deer Creek Waterworks WWTP service area (which includes a portion of Annetta and part of the area between Annetta and Annetta South) is collected and transported to the Deer Creek Waterworks WWTP for treatment.

Wastewater generated in residential areas of Hudson Oaks and most residential areas of Willow Park is treated by septic systems. With the exception of wastewater customers of the Deer Creek Waterworks, wastewater generated in Annetta, Annetta North, Annetta South, and the portion of Fort Worth's ETJ located in the Planning Area is also treated by septic systems. Based on Census population and housing unit data, it is estimated that there are approximately 5,400 septic systems in the Planning Area.

**Figure 1-1**  
**Regional Wastewater Facilities Planning Area**



### **1.1.3 Previous Planning Efforts**

Several plans for regional wastewater treatment in the Planning Area have been published in the last 20 years. These include a 1988 study conducted for the Tarrant County Water Control and Improvement District Number One (TCWCID #1, now Tarrant Regional Water District), a 1988 plan developed for the Trinity River Authority (TRA), a 2004 plan developed for the Brazos River Authority (BRA) and the Tarrant Regional Water District (TRWD), and 2004 planning by Fort Worth. WWTP locations from these studies were considered in the current planning project.

### **1.1.4 Current Planning**

The current planning project considers regional wastewater treatment facilities to provide wastewater service to Aledo, Annetta, Annetta North, Annetta South, part of Fort Worth, Hudson Oaks, Willow Park, and Weatherford. The project will identify infrastructure improvements through 2030 that are necessary to implement a regional wastewater treatment system. 2030 was chosen as the end of the planning period because it is the last year for which certain population projections are available. Key decisions on how to configure and implement a regional wastewater system must be made prior to 2030, so the choice of 2030 as the end of the planning period will not impact these decisions. Additional infrastructure improvements will be necessary beyond 2030, but these improvements will not be included in this report.

## **1.2 POPULATION AND WASTEWATER FLOW PROJECTIONS**

Table 1-1 and Table 1-2 show the projected populations and wastewater flows for each city/CCN in the Planning Area. Sources of population and flow projections are discussed in Chapter 3.

## **1.3 POTENTIAL REGIONAL WASTEWATER TREATMENT PLANT SITES**

Four potential regional WWTP sites were selected for analysis: a Center Point site, a South Willow Park site, a Confluence site, and a Clear Fork site (Figure 1-2). These sites represent general areas and do not represent any particular individual properties. Potential regional WWTP sites were selected after consideration of potential WWTP sites that were recommended in previous studies (Section 1.1.3) and through recommendations from the Participants. The potential for beneficial interaction between the Clear Fork site and the proposed Fort Worth Mary's Creek Water Recycling Center was also considered.

**Table 1-1  
Projected Population by City/CCN**

<b>City/CCN</b>	<b>2000</b>	<b>2010</b>	<b>2020</b>	<b>2030</b>
Aledo	1,726	4,110	7,940	11,769
Annetta	1,108	1,579	1,972	2,289
Annetta North	467	666	832	966
Annetta South	555	708	836	939
Fort Worth (Planning Area)	0	1,331	5,766	8,870
Hudson Oaks	1,637	2,960	4,262	5,673
Weatherford	19,000	25,412	32,161	38,365
Willow Park	2,849	3,211	6,187	13,631
Deer Creek Waterworks <sup>1</sup>	200	275	338	388
<b>Total</b>	<b>27,542</b>	<b>40,252</b>	<b>60,294</b>	<b>82,890</b>

**Table 1-2  
Projected Annual Average Wastewater Flow by City/CCN (mgd<sup>2</sup>)**

<b>City/CCN</b>	<b>2010</b>	<b>2020</b>	<b>2030</b>
Aledo	0.29	0.75	1.26
Annetta	0.16	0.20	0.23
Annetta North	0.07	0.08	0.10
Annetta South	0.07	0.08	0.09
Fort Worth (Planning Area)	0.16	0.69	1.06
Hudson Oaks	0.36	0.51	0.68
Weatherford	3.05	3.86	4.60
Willow Park	0.32	0.62	1.36
Deer Creek Waterworks <sup>1</sup>	0.03	0.03	0.04
<b>Total</b>	<b>4.50</b>	<b>6.83</b>	<b>9.43</b>




















---

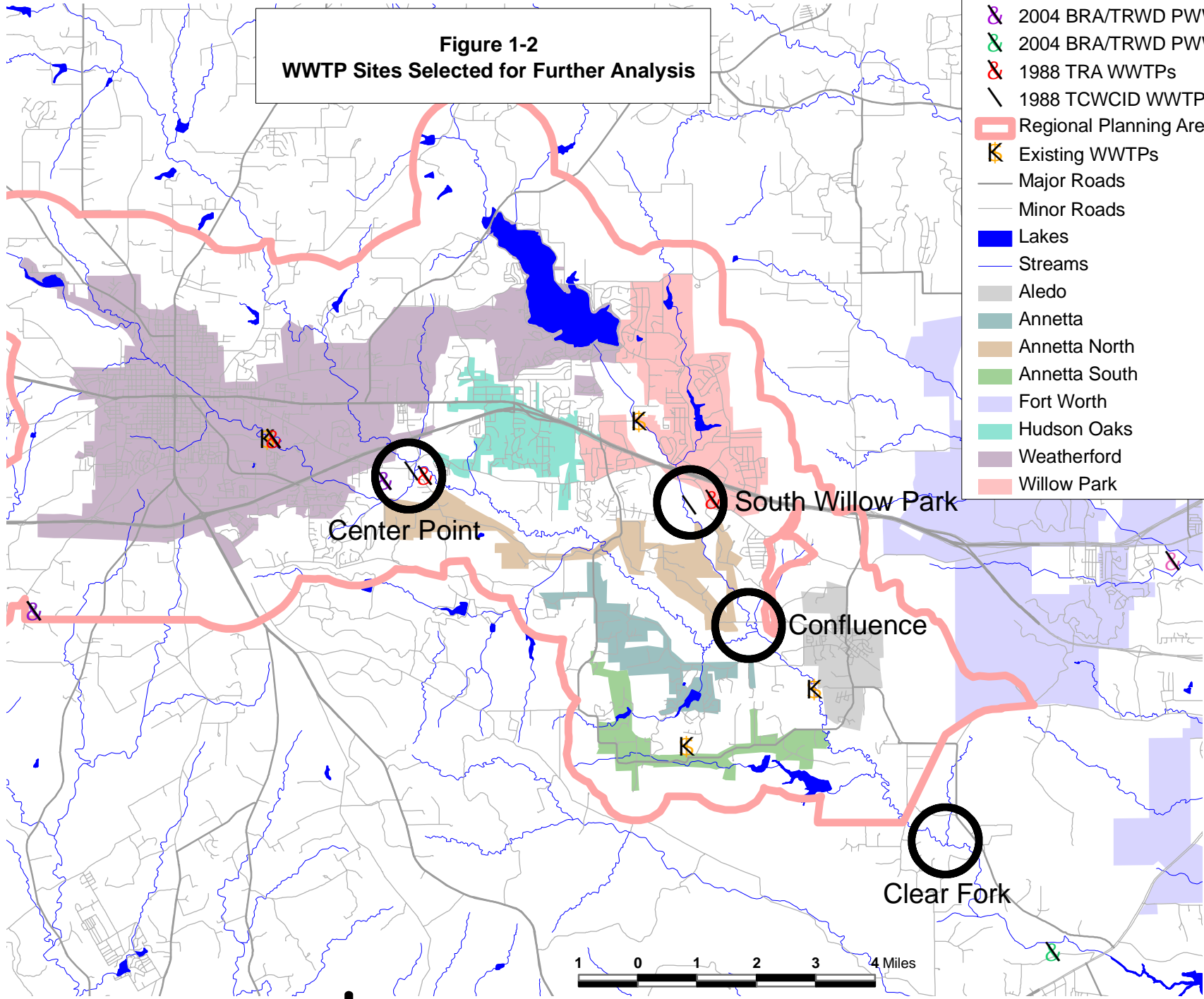
<sup>1</sup> The projected population and wastewater flow for the Deer Creek Waterworks CCN represents the portion that is not included in the projections for Annetta.

<sup>2</sup> Million gallons per day.



**Figure 1-2  
WWTP Sites Selected for Further Analysis**

-  2004 Mary's Creek WRC
-  2004 BRA/TRWD PWW-1
-  2004 BRA/TRWD PWW-2
-  1988 TRA WWTPs
-  1988 TCWCID WWTPs
-  Regional Planning Area
-  Existing WWTPs
-  Major Roads
-  Minor Roads
-  Lakes
-  Streams
-  Aledo
-  Annetta
-  Annetta North
-  Annetta South
-  Fort Worth
-  Hudson Oaks
-  Weatherford
-  Willow Park



## **1.4 CONCEPTUAL DESIGN FOR REGIONAL COLLECTION SYSTEM**

An optimization method was used to identify the target low-cost regional collection system configuration based on 2030 conditions, then steps were identified to transition from existing wastewater treatment in the Planning Area toward the target configuration, resulting in an implementation plan for the regional collection system.

It is not feasible to construct the entire regional collection system immediately. Annetta, Annetta North, Annetta South, and the portion of Fort Worth in the Planning Area do not have local wastewater collection systems. In addition, Hudson Oaks and Willow Park have collection systems that serve only a small part of each city. Time is needed to develop these local collection systems. Therefore, the regional collection system should be implemented in phases (Figure 1-3) according to projected needs. It is anticipated that Phase 1 would be implemented by 2012, Phase 2 by 2016, and Phase 3 by 2021.

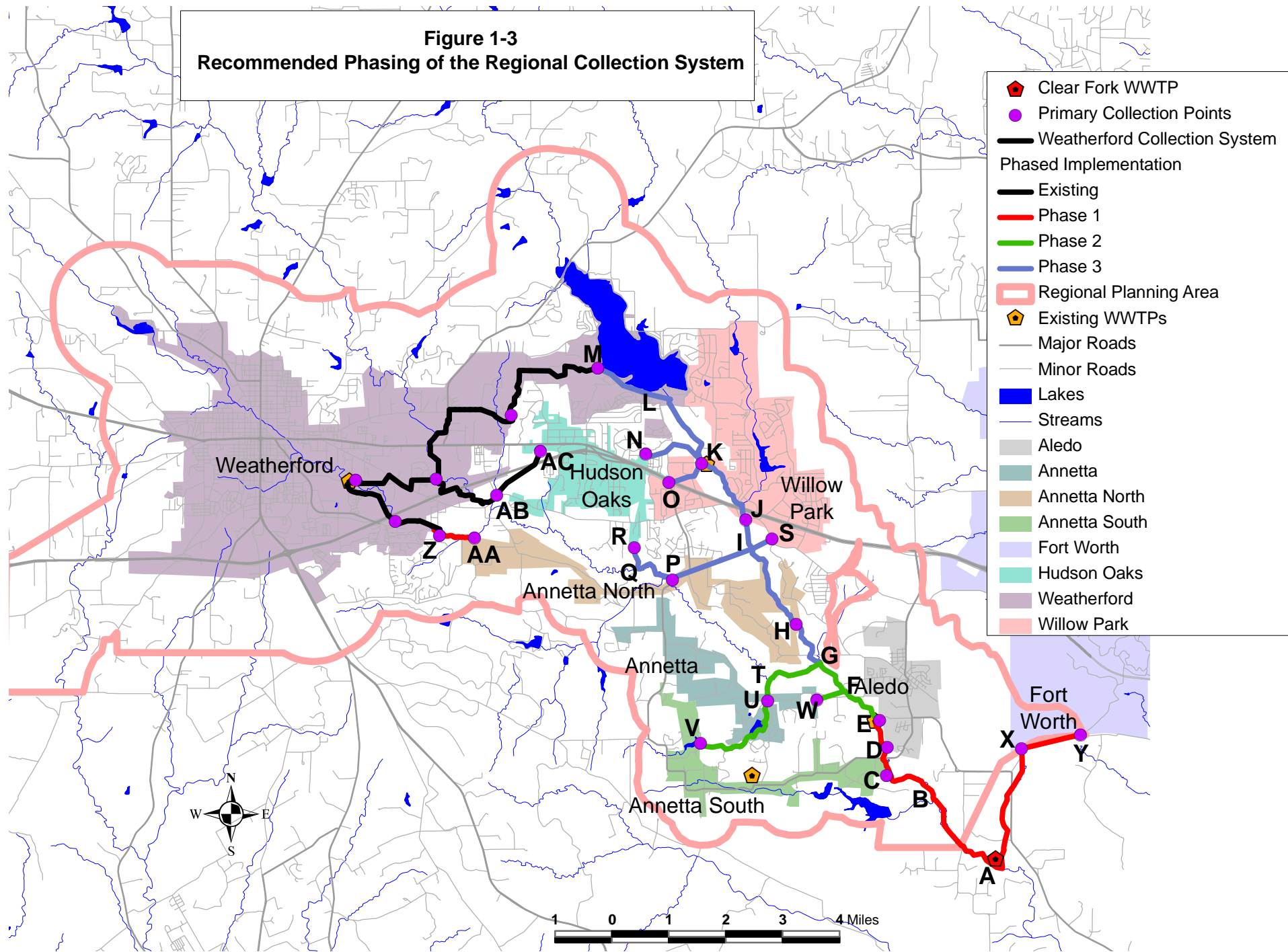
Weatherford would begin to contribute flow from the Lake Weatherford area (Lift Station 14) to the regional system in Phase 3. Until Phase 3 is implemented, Weatherford should make any improvements necessary to continue to convey flow from Lift Station 14 to the Weatherford WWTP. Upon completion of Phase 3, it has been assumed that Weatherford will continue to convey part of its flow to the Weatherford WWTP and that excess flow will go to the Clear Fork WWTP.

Implementation details (facilities, sizes, phases, opinions of cost, etc.) for the regional collection system are presented in Appendix C.

## **1.5 RECOMMENDED EFFLUENT WATER QUALITY**

The potential impact of effluent water quality on dissolved oxygen in the Clear Fork Trinity River and on algal growth in Benbrook Lake was analyzed with a stream water quality model (QUAL-TX) and a reservoir water quality model (WASP). These analyses are described in Chapter 6, and the results are presented in Table 1-3.

**Figure 1-3**  
**Recommended Phasing of the Regional Collection System**



**Table 1-3  
2030 Projected Treated Effluent Water Quality Requirements (mg/l)**

<b>Item</b>	<b>Weatherford WWTP</b>	<b>Aledo WWTP</b>	<b>Clear Fork WWTP</b>	<b>Concern</b>
Maximum CBOD	10	10	10	Dissolved Oxygen
Maximum Ammonia	2	2	2	Dissolved Oxygen
Minimum Dissolved Oxygen	5	5	5	Dissolved Oxygen
Maximum Total Phosphorus	1	1	1	Algal Growth

Treated effluent contains oxygen-demanding substances, such as carbonaceous biochemical oxygen demand (CBOD) and ammonia, that cause a decrease in dissolved oxygen in the receiving stream until such substances are oxidized. The decrease in dissolved oxygen caused by treated effluent discharged from the Weatherford WWTP completely disappears before reaching the Aledo WWTP. Therefore, the effluent water quality requirements for the Weatherford WWTP are independent of the requirements at the downstream WWTPs. However, effluent water quality requirements at the Aledo WWTP and the Clear Fork WWTP are interdependent.

It is important to note that the water discharged from the Weatherford WWTP provides dilution water for the downstream plants. Weatherford is currently developing a reclaimed water plan. If Weatherford reuses all of its reclaimed water and does not discharge any water from the WWTP, it is projected that the effluent water quality requirements at the Clear Fork WWTP would be 5 milligrams per liter (mg/l) maximum CBOD, 1.8 mg/l maximum ammonia, 5 mg/l minimum dissolved oxygen, and 1 mg/l maximum total phosphorus.

## **1.6 CONCEPTUAL DESIGN FOR REGIONAL WASTEWATER TREATMENT FACILITIES**

To provide treatment for the projected wastewater flow, the Clear Fork WWTP will be constructed in three phases, as shown in Table 1-4. In accordance with Texas Commission on Environmental Quality (TCEQ) design criteria, the Clear Fork WWTP will accommodate a two-hour peak flow of four times the annual average flow.<sup>3,a</sup>

---

<sup>3</sup> In this report, numbered footnotes are used to indicate relevant information at the bottom of the same page, and lettered footnotes represent source references presented at the end of the report.

**Table 1-4  
Clear Fork WWTP Phases and Capacities**

<b>Phase</b>	<b>Additional Annual Average Capacity (mgd)</b>	<b>Total Annual Average Capacity (mgd)</b>	<b>Total Peak Flow Capacity (mgd)</b>
1	1.25	1.25	5.00
2	1.25	2.50	10.00
3	2.50	5.00	20.00

The influent untreated wastewater is estimated to have the following concentrations:

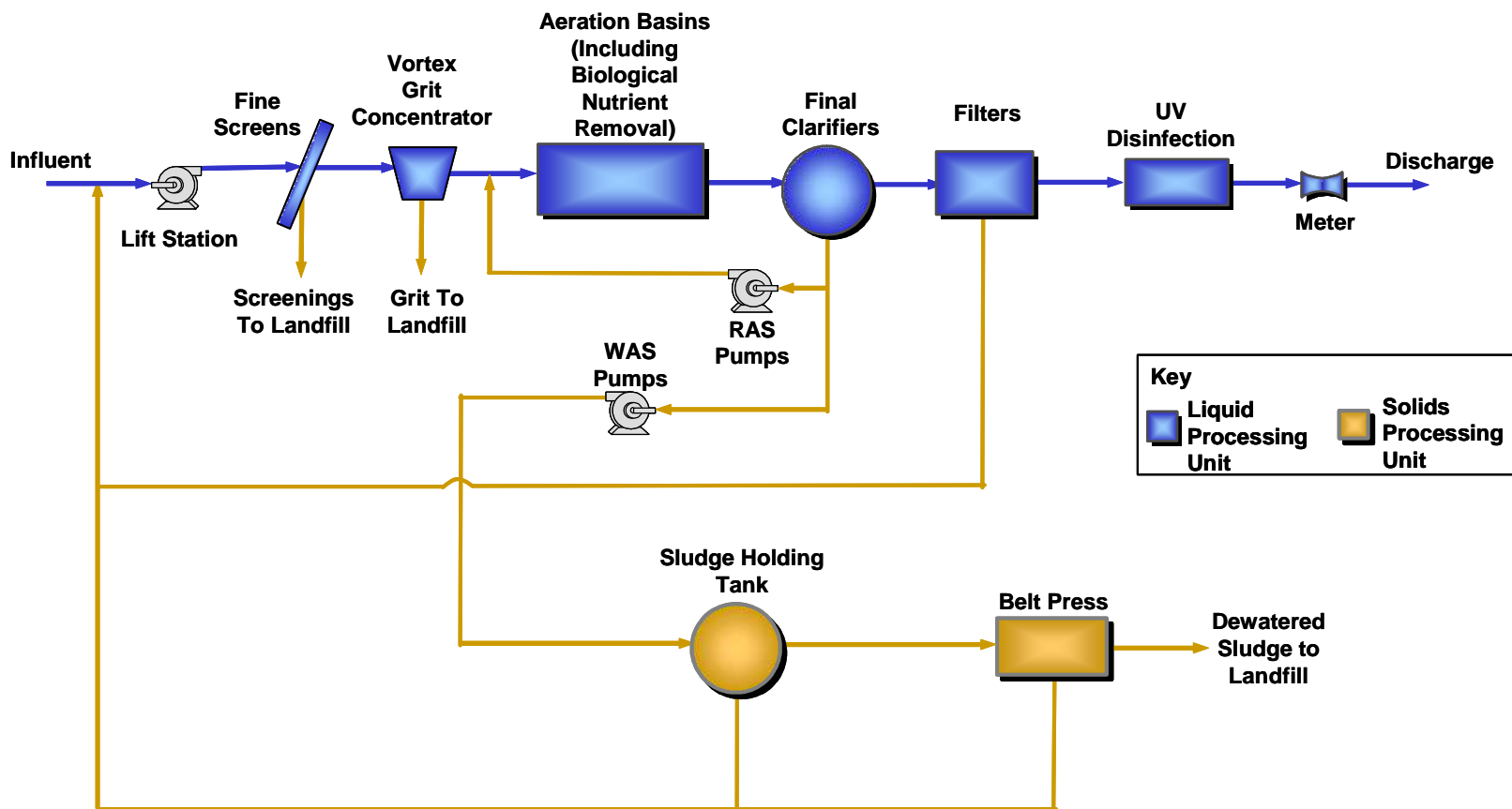
- CBOD of 200 mg/l,
- Total suspended solids (TSS) of 200 mg/l,
- Ammonia of 25 mg/l, and
- Total phosphorus of 6 mg/l.

A treatment process schematic is shown in Figure 1-4. Complete details about the conceptual design of the regional WWTP are presented in Chapter 7.

#### 1.6.1 **Weatherford WWTP**

Most flows generated within the city limits of Weatherford and flows generated in portions of Annetta North and Hudson Oaks would be treated at the Weatherford WWTP. Upon completion of Phase 3 of the regional system, it has been assumed that Weatherford will convey part of the flow generated in the Lake Weatherford area to the Weatherford WWTP and that flow in excess of Weatherford's conveyance capacity will be directed to the Clear Fork WWTP (through Segment M-L in).

**Figure 1-4  
Clear Fork WWTP Treatment Process Schematic**



### 1.6.2 **Willow Park WWTP**

The Willow Park WWTP is projected to continue to treat flow generated from approximately 34 percent of the City's population, primarily in the northwest part of Willow Park until completion of Phase 3 of the regional system in about 2021. The percentage of population served was estimated using current flows to the Willow Park WWTP and the projected per capita flow contribution. When regional wastewater treatment is available, it is anticipated that the Willow Park WWTP will be taken out of service and that all flows generated in Willow Park will be conveyed to the Clear Fork WWTP for treatment.<sup>4</sup>

Based on projected population growth, it is projected that wastewater flow to the Willow Park WWTP will be just less than the treatment capacity of 0.24 million gallons per day (mgd) when the regional system becomes available in approximately 2021. If Willow Park extends service to a greater portion of the city or if population growth is faster than projected, then wastewater flow to the plant could exceed the treatment capacity, requiring expansion of the Willow Park WWTP.

### 1.6.3 **Aledo WWTP**

Although design of improvements to the Aledo WWTP is in progress, it has been assumed that Aledo will manage future wastewater flows and operate its WWTP without expansion until it can connect to Phase 1 of the regional wastewater system. Management of future flows, through control of infiltration and inflow and by limiting new wastewater service, would delay some of the projected growth in wastewater flows until after Aledo has connected to a regional wastewater system. When regional wastewater treatment is available, it is anticipated that the Aledo WWTP will be taken out of service and that all flows generated in Aledo will be conveyed to the Clear Fork WWTP for treatment.

### 1.6.4 **Deer Creek Waterworks WWTP**

The Deer Creek Waterworks WWTP is projected to treat flow generated in its current service area until completion of Phase 2 of the regional system in about 2016. When regional

---

<sup>4</sup> Although a South Willow Park WWTP did not appear feasible during the current planning project due to the potential for permitting difficulties and public opposition, the feasibility of serving Willow Park and portions of Hudson Oaks and Annetta North with a South Willow Park WWTP should be reevaluated during planning for Phase 2. Should this plant become feasible, the regional wastewater service provider could accelerate implementation of Phase 3 by providing wastewater treatment at a South Willow Park WWTP.

wastewater treatment is available, it is anticipated that the Deer Creek Waterworks WWTP will be taken out of service and that all flows generated in the Deer Creek Waterworks service area will be conveyed to the Clear Fork WWTP for treatment. It has been assumed that the existing facilities can be adapted to transport raw wastewater to the regional collection system.

Based on projected population growth, it is projected that wastewater flow to the Deer Creek Waterworks WWTP will exceed the existing annual average treatment capacity of 0.1056 mgd a few months before the regional system becomes available. This could be addressed by expanding the treatment capacity, but expansion is unlikely to be economical. Therefore, it has been assumed that Willow Park, which owns the Deer Creek Waterworks system, will manage future flows by one or more of the following methods: reducing infiltration and inflow to the collection system, limiting new wastewater service, uprating the treatment capacity, and/or accelerating Phase 2 of the regional system.

#### 1.6.5 **Summary**

The concepts expressed above are meant to provide guidance on how to achieve a cost-effective regional wastewater system through 2030. However, it is not possible to predict everything that will occur during the planning period. Valid reasons may arise to justify deviation from these concepts. Valid reasons may include:

- Changes in the economics of regional wastewater treatment. Significant changes in cost from those presented in Appendix B may justify changes to this facilities plan. For example, changing conditions could make it feasible for the regional wastewater service provider to acquire an existing WWTP and to operate it as part of the regional system. The regional wastewater service provider and the WWTP owners should reevaluate the feasibility of continuing to operate an existing WWTP as an element of the regional system prior to taking existing WWTPs out of service.
- Changes in the feasibility of implementing a South Willow Park WWTP to serve Phase 3 of the regional system.
- The desire of a city to provide wastewater service to its citizens over a larger area than assumed above before regional service is available.
- Reclaimed water supply opportunities. If a large reclaimed water customer is identified, it may be beneficial to continue to operate an existing WWTP to provide a nearby source of reclaimed water.

However, deviation from the concepts in this plan should not be pursued if it will adversely affect implementation of a regional wastewater system.



## **1.7 POTENTIAL RECLAIMED WATER CUSTOMERS**

State regulations on reclaimed water use and potential reclaimed water customers are discussed and identified in Chapter 8.

## **1.8 OPINION OF PROBABLE CAPITAL COST**

An opinion of probable capital cost was developed for the regional wastewater conveyance system and the Clear Fork WWTP (Table 1-5). Construction costs include contractors' mobilization, overhead, and profit. Opinions of probable construction cost for regional interceptors and force mains, lift stations, and wastewater treatment facilities have been listed separately. Costs for engineering, legal services, construction management, contingencies, land and rights-of-way, permitting, and mitigation are also listed separately. All costs are shown in 2007 dollars. The total opinion of probable capital cost for regional wastewater facilities through 2030 is approximately \$84.2 million.

An opinion of annual cost has also been developed for a regional wastewater conveyance system and the Clear Fork WWTP. Annual cost items include debt service on the capital expenditures and operation and maintenance (O&M) costs. Although the opinion of probable annual cost is useful in showing the projected financial obligations of a regional wastewater system, it does not fully convey whether the system is affordable. Therefore, an opinion of probable unit cost was also developed. The opinion of probable unit cost is the probable annual cost normalized by the projected wastewater flowrate. Figure 1-5 demonstrates that 50 percent State Participation financing (discussed in Chapter 9) makes the project more affordable. The opinion of probable unit cost is less than \$5 per thousand gallons by about 2014.

## **1.9 IMPLEMENTATION PLAN**

A general description of actions by phase, actions during all phases, and project timing is presented below. The details are presented in Chapter 10.

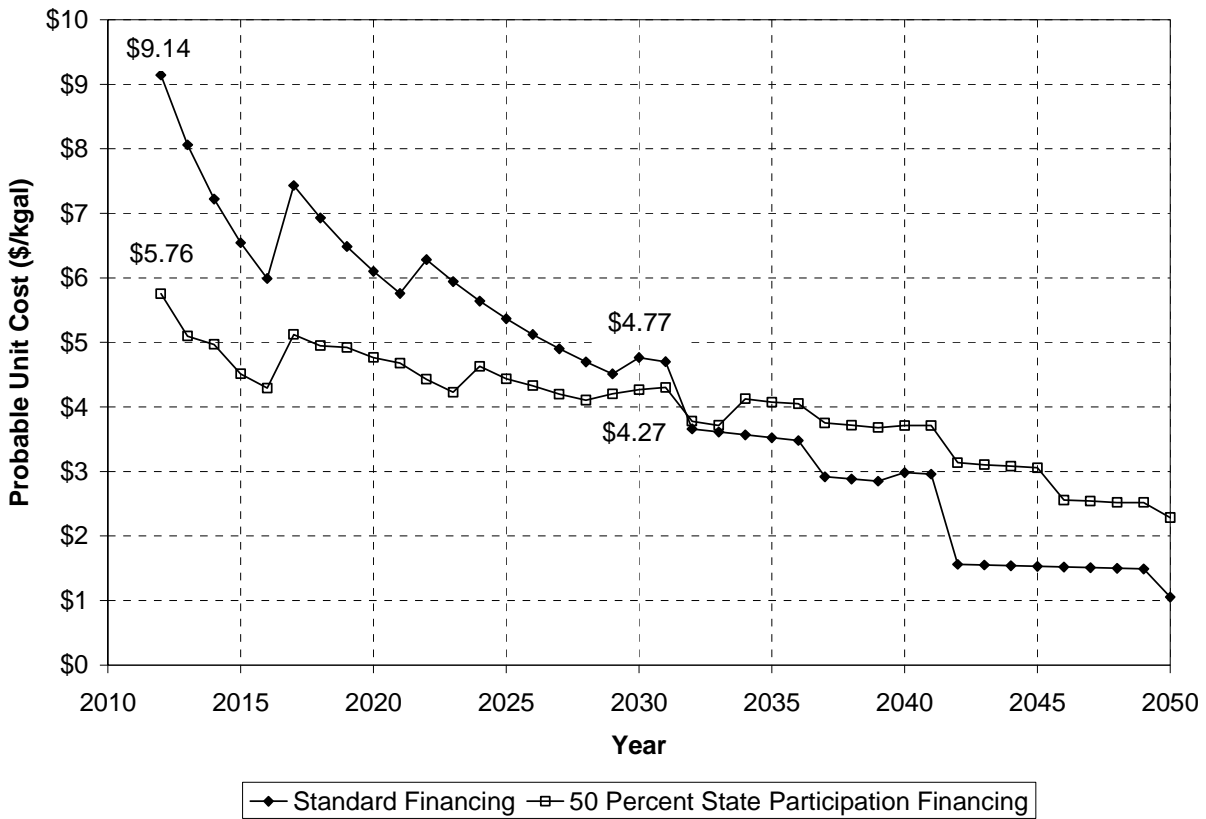
### **1.9.1 Actions by Phase**

Phase 1 actions include continuing Participant meetings, identifying a regional wastewater service provider, negotiating service agreements with the Participants, planning and

**Table 1-5  
Opinion of Probable Capital Cost for Eastern Parker County Regional Wastewater Facilities (2007 Dollars)**

<b>Category</b>	<b>Item</b>	<b>Phase 1 (2012)</b>	<b>Phase 2 (2016)</b>	<b>Phase 3 (2021)</b>	<b>Phase 4 (2030)</b>	<b>Total</b>
Interceptors and Force Mains	Construction Cost	\$6,182,376	\$3,796,375	\$15,710,135	\$0	\$25,688,885
	Right of Way	\$777,081	\$241,767	\$594,061	\$0	\$1,612,909
Lift Stations	Construction Cost	\$324,834	\$177,173	\$696,320	\$290,773	\$1,489,100
	Land	\$40,000	\$0	\$20,000	\$0	\$60,000
Wastewater Treatment	New WWTP	\$8,295,000	\$0	\$0	\$0	\$8,295,000
	WWTP Expansion	\$0	\$4,400,000	\$8,930,000	\$8,295,000	\$21,625,000
	Land	\$400,000	\$0	\$0	\$0	\$400,000
<b>Construction Cost Subtotal</b>		<b>\$16,019,290</b>	<b>\$8,615,315</b>	<b>\$25,950,517</b>	<b>\$8,585,773</b>	<b>\$59,170,895</b>
Engineering, Legal, Construction Management, and Contingencies	Interceptors and Force Mains (30%)	\$1,854,713	\$1,138,912	\$4,713,041	\$0	\$7,706,666
	Lift Stations (35%)	\$113,692	\$62,011	\$243,712	\$101,770	\$521,185
	Wastewater Treatment (35%)	\$2,903,250	\$1,540,000	\$3,125,500	\$2,903,250	\$10,472,000
Permitting and Mitigation	Interceptors, Lift Stations, WWTP Site	\$177,627	\$47,683	\$196,877	\$3,489	\$425,676
	WWTP Discharge Permit	NA*	NA	NA	NA	NA
<b>Capital Cost Subtotal</b>		<b>\$21,068,571</b>	<b>\$11,403,921</b>	<b>\$34,229,647</b>	<b>\$11,594,283</b>	<b>\$78,296,422</b>
Interest During Construction		\$1,647,436	\$891,718	\$2,676,553	\$667,750	\$5,883,457
<b>Capital Cost Total</b>		<b>\$22,716,007</b>	<b>\$12,295,639</b>	<b>\$36,906,200</b>	<b>\$12,262,032</b>	<b>\$84,179,878</b>
*Costs for WWTP discharge permits are highly variable and have not been included in the opinion of capital cost.						

**Figure 1-5  
Opinion of Probable Unit Cost for Eastern Parker County Regional Wastewater System  
(2007 Dollars)**



constructing local collection systems,<sup>5</sup> designing regional wastewater facilities, obtaining financing, acquiring a WWTP site, permitting a WWTP and conveyance facilities, constructing regional facilities, and retiring the Aledo WWTP. Phase 1 is expected to be complete by 2012.

Phase 2 actions include reevaluating the feasibility of a South Willow Park WWTP to serve Phase 3, planning and constructing local collection systems,<sup>6</sup> constructing regional wastewater facilities, and retiring the Deer Creek Waterworks WWTP. Phase 2 is expected to be complete by 2016.

<sup>5</sup> For Aledo, Annetta North, Annetta South, and Fort Worth. The cost for local collection system improvements will be the responsibility of the local entity.

<sup>6</sup> Annetta and Annetta South.

Phase 3 actions include planning and constructing local collection systems,<sup>7</sup> constructing regional wastewater facilities, and retiring the Willow Park WWTP. Phase 3 is expected to be complete by 2021.

### 1.9.2 **Actions During All Phases**

During all phases, the Service Provider should continue to identify potential reclaimed water customers and develop plans to provide service to these customers. Revenue from reclaimed water sales could significantly reduce the costs borne by the Participants. This potential revenue was not included in the opinions of cost in Figure 1-5.

### 1.9.3 **Project Timing**

The timing of Phase 1 is critical to Aledo. Although design of improvements to the Aledo WWTP is in progress, it has been assumed that Aledo will manage future wastewater flows and operate its WWTP without expansion until it can connect to Phase 1 of the regional wastewater system. Management of future flows, through control of infiltration and inflow and by limiting new wastewater service, would delay some of the projected growth in wastewater flows until after Aledo has connected to the regional wastewater system. Therefore, it is important to Aledo that Phase 1 be completed as soon as possible.

The timing of Phase 2 is critical to the Deer Creek Waterworks WWTP. It is projected that wastewater flow to the Deer Creek Waterworks WWTP will exceed the existing annual average treatment capacity of 0.1056 mgd a few months before the regional system becomes available. This could be addressed by expanding the treatment capacity, but expansion is unlikely to be economical. Therefore, it has been assumed that Willow Park, which owns the Deer Creek Waterworks system, will manage future flows by one or more of the following methods: reducing infiltration and inflow to the collection system, limiting new wastewater service, uprating the treatment capacity, and/or accelerating Phase 2 of the regional system.

The timing of Phase 3 is critical to Willow Park. It is projected that wastewater flow to the Willow Park WWTP will be just less than the treatment capacity of 0.24 mgd when the regional system becomes available in approximately 2021. If Willow Park extends service to a greater portion of

---

<sup>7</sup> Annetta North, Hudson Oaks, and Willow Park.

the city or if population growth is faster than projected, then wastewater flow to the plant could exceed the treatment capacity, requiring expansion of the Willow Park WWTP, flow management, or acceleration of Phase 3 of the regional wastewater system.

The timing of the Phase 3 is also important to Hudson Oaks and Annetta North, which cannot connect to the regional wastewater system until Phase 3 is completed. Should wastewater service become necessary before Phase 3 is completed, these cities will have to identify and implement interim measures.

## **CHAPTER 2**

### **INTRODUCTION**

Eastern Parker County is expected to experience rapid growth in the coming years. However, much of the area depends on individual septic systems for wastewater treatment. The cities in eastern Parker County have expressed interest in the feasibility of regional wastewater treatment facilities. Regionalization of wastewater treatment in eastern Parker County could:

- Provide additional treatment capacity to meet projected growth,
- Reduce reliance on septic systems,
- Protect the quality of groundwater and surface water (both of which are drinking water sources) in the Clear Fork Trinity River watershed,
- Reduce wastewater treatment costs through economies of scale,
- Provide updated wastewater treatment technology,
- Provide greater access to capital funding, and
- Prevent proliferation of numerous, small utilities.

This report details an implementation plan for developing regional wastewater facilities in eastern Parker County. The following sections present background information, describe the regional wastewater facilities planning area, review existing wastewater treatment facilities in the regional planning area, summarize previous regional wastewater treatment plans, and discuss the current planning effort.

### **2.1 BACKGROUND**

Representatives from Aledo, Annetta, Annetta North, Annetta South, Fort Worth, Hudson Oaks, Parker County Utility District No. 1 (PCUD), the Tarrant Regional Water District (TRWD), and Weatherford began meeting in 2005 to assess the feasibility of regional wastewater treatment facilities. All agreed that there was sufficient interest in regional wastewater treatment to warrant development of a regional wastewater treatment facilities plan.

With assistance from Alan Plummer Associates, Inc. (APAI), these entities applied for a Research and Planning Fund Grant from the Texas Water Development Board (TWDB). After the grant application was submitted, Willow Park joined the regional wastewater planning process. In June 2006, the TWDB awarded a grant of \$67,375 to fund 50 percent of the development of the Eastern Parker County Regional Wastewater Facilities Plan (the Plan). The

remaining 50 percent was funded by the participating entities through contributions of cash and in-kind services.

## **2.2 REGIONAL WASTEWATER FACILITIES PLANNING AREA**

The regional wastewater facilities planning area (the Planning Area) comprises a large portion of eastern Parker County (Figure 2-1), including numerous political subdivisions. The location, political subdivisions, and demographics of the Planning Area are described in the following sections.

### **2.2.1 Location**

Figure 2-2 shows the regional wastewater facilities planning area, which consists of the Participants' city limits, Certificate of Convenience and Necessity (CCN) service areas, and extraterritorial jurisdictions (ETJs). The Planning Area includes approximately 74,500 acres in eastern Parker County, located almost entirely within the Clear Fork Trinity River basin. A small portion of Weatherford's city limits, CCN, and ETJ is located in the Brazos River Basin, and a small portion of Willow Park's ETJ is located within the West Fork Trinity River Basin.

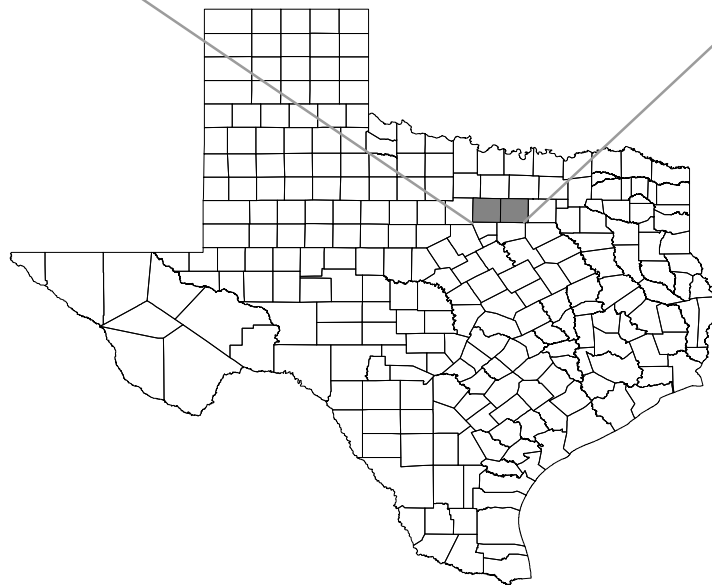
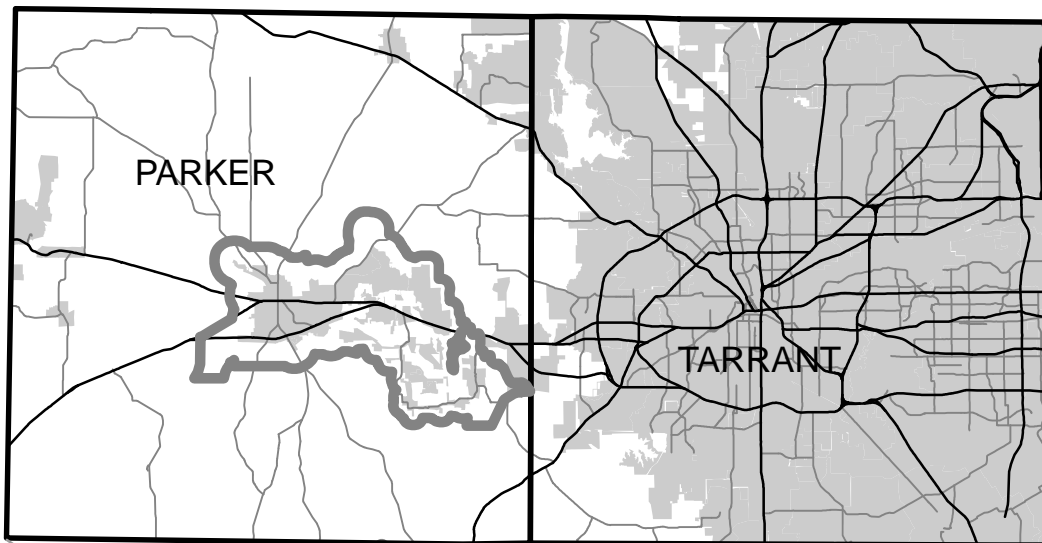
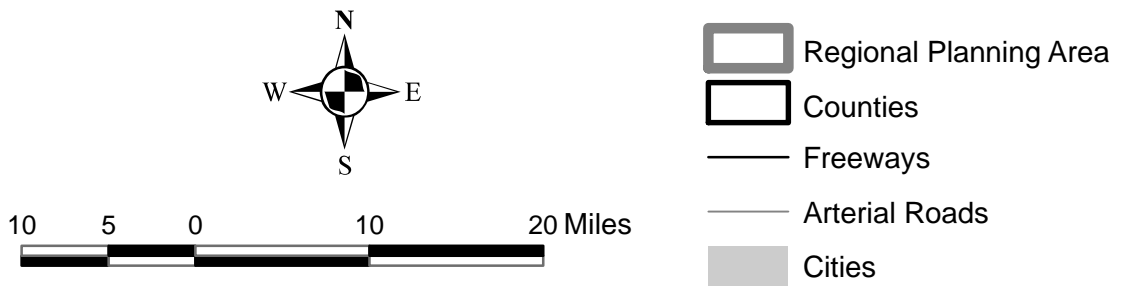
### **2.2.2 Political Subdivisions**

The following political subdivisions (the Participants) participated in development of the Plan:

- City of Aledo
- Town of Annetta
- Town of Annetta North
- Town of Annetta South
- City of Fort Worth
- City of Hudson Oaks
- Parker County Utility District No. 1 (PCUD)
- Tarrant Regional Water District (TRWD)
- City of Weatherford
- City of Willow Park

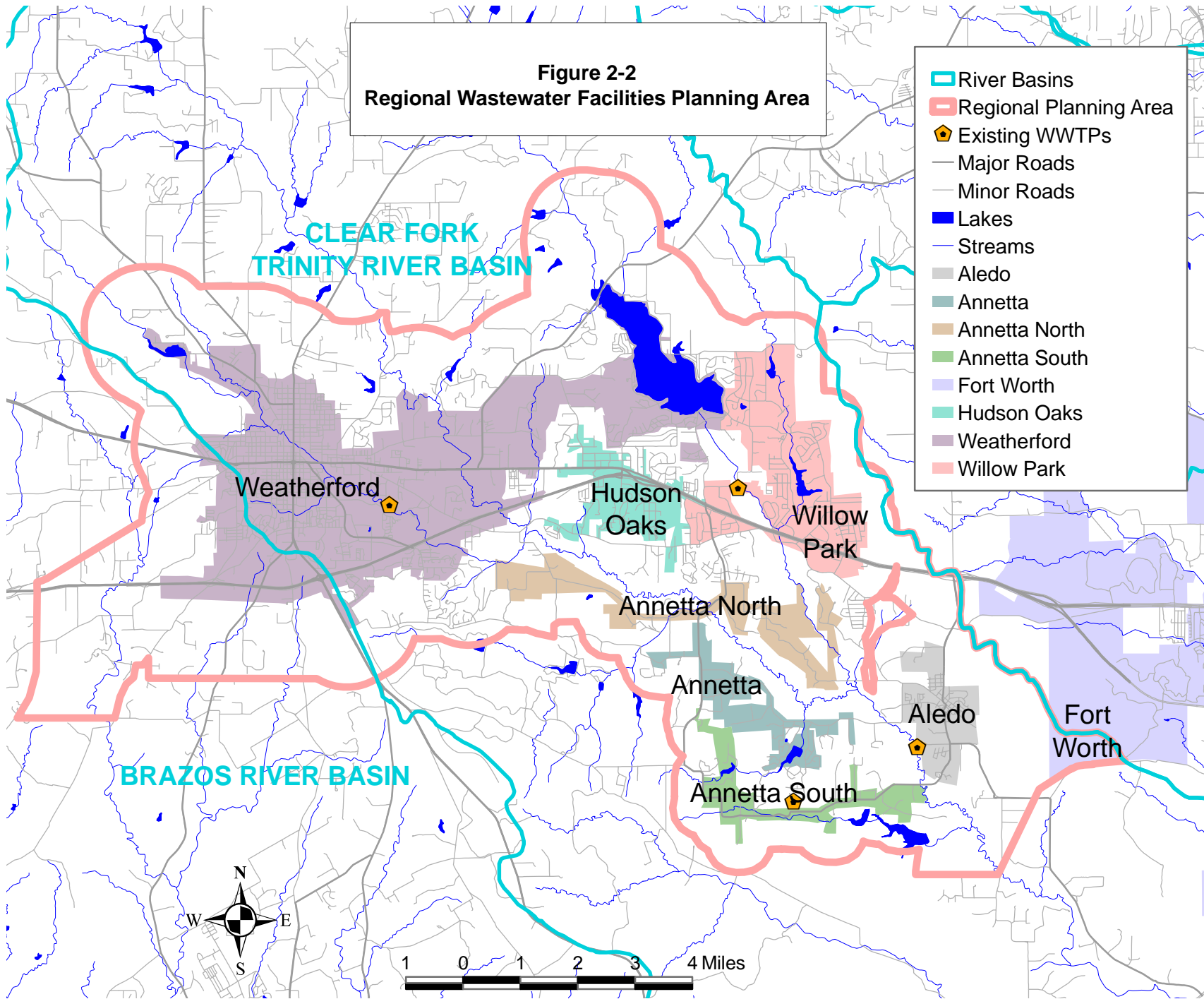
Other political subdivisions located in the Planning Area include Parker County, Deer Creek Waterworks, and Trinity River Authority. These entities did not participate in development of the Plan. Willow Park purchased the Deer Creek Waterworks utility in 2005 and has been operating

**Figure 2-1**  
**Regional Wastewater Facilities Planning Area Location Map**





**Figure 2-2**  
**Regional Wastewater Facilities Planning Area**



its water and wastewater systems since that time. Willow Park has applied to transfer the CCN from the Deer Creek Waterworks to Willow Park.

Most of the Participants are cities having all or part of their city limits and ETJ located in the Planning Area, and regional wastewater planning directly affects their residents. PCUD and TRWD are the only non-city Participants. PCUD is a potential regional wastewater service provider. The Texas Legislature created PCUD in 1997 as a regional wastewater district. Although PCUD's statutory service area is located in northeastern Parker County and southern Wise County, it has the authority<sup>8</sup> to plan, develop, and operate a regional wastewater facility for the Planning Area.

TRWD does not provide wastewater service, but it manages the water supply operations of Lake Benbrook just downstream of the Planning Area and provides raw water from Lake Benbrook to Weatherford and Fort Worth. Therefore, the TRWD has a vested interest in the water quality in the Clear Fork Trinity River, which drains the Planning Area.

The Planning Area includes the service areas of the following sewer CCNs (with CCN numbers in parentheses):

- Aledo (20102)
- Deer Creek Waterworks (20849)
- Hudson Oaks (20838)
- Weatherford (20109)
- Willow Park (20773)

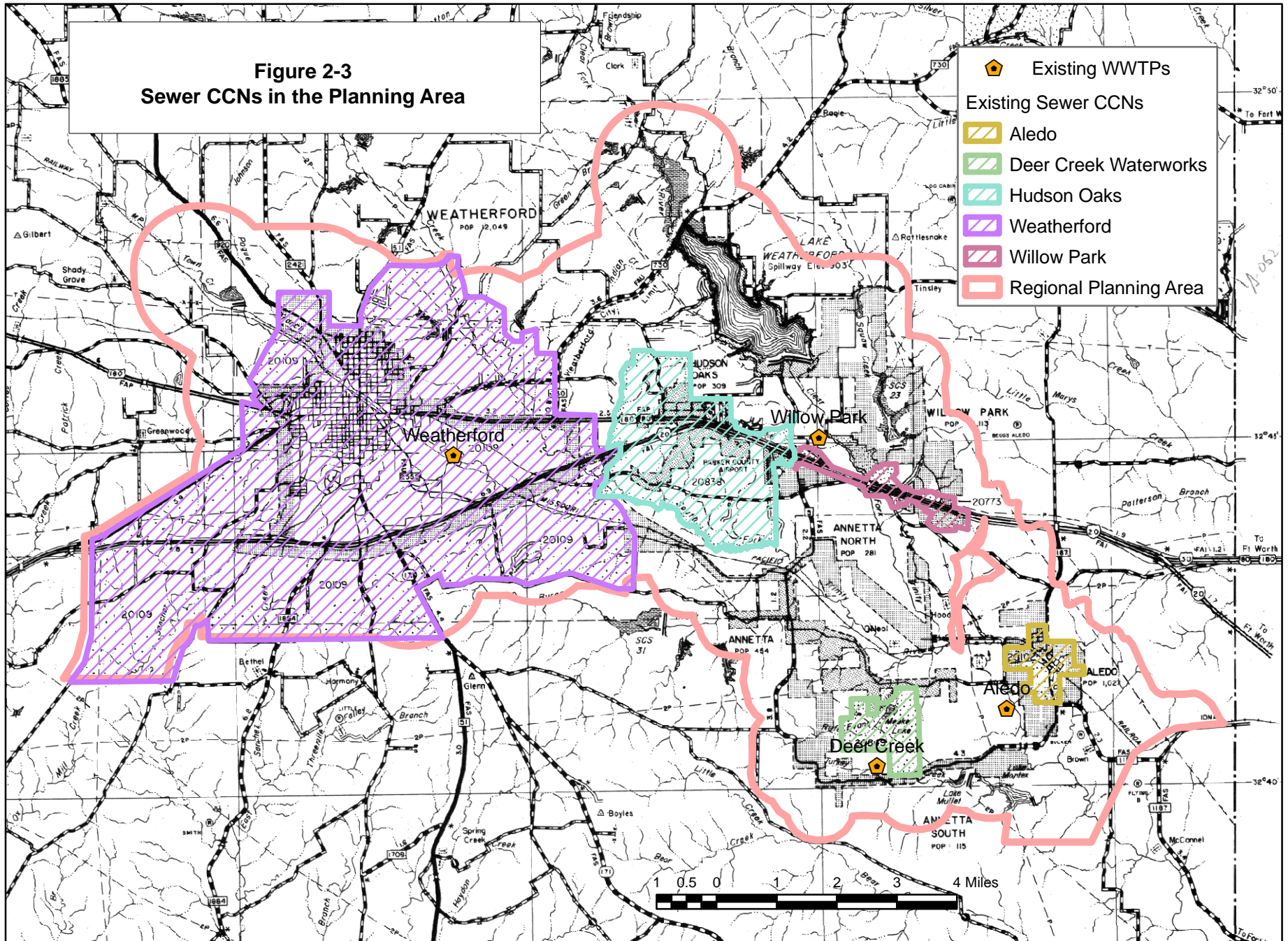
The location of each sewer CCN is shown in Figure 2-3. A sewer CCN defines the geographic area in which a utility is legally entitled to provide retail sewer service and grants an exclusive right to provide this service.<sup>9,b</sup> Investor-owned utilities and non-profit water supply or sewer service corporations are required to obtain CCNs. A municipality is not required to obtain a CCN to provide retail sewer service to an area or customers not currently being served.<sup>b</sup>

---

<sup>8</sup> As does each Participant.

<sup>9</sup> In this report, numbered footnotes are used to indicate relevant information at the bottom of the same page, and lettered footnotes represent source references presented at the end of the report.

**Figure 2-3  
Sewer CCNs in the Planning Area**



\*The base map is a Parker County Sewer CCN map obtained from the Texas Commission on Environmental Quality

Retail sewer service providers can contract for wholesale wastewater treatment from a regional wastewater system. A regional wastewater system that provides wholesale (and not retail) services does not need to obtain a CCN.

Willow Park has applied to amend its CCN to include 825 acres to the east of Willow Park. This application is currently on hold until details can be resolved with Fort Worth and prospective developers.

## **2.3 EXISTING WASTEWATER TREATMENT**

Wastewater treatment in the Planning Area consists of wastewater treatment plants and septic systems, as summarized in Table 2-1. Each is discussed below.

### **2.3.1 Wastewater Treatment Plants**

Wastewater generated in Aledo and Weatherford and in a limited portion of Willow Park is collected and transported to city-owned wastewater treatment plants (WWTPs). Wastewater generated in the commercial area of Hudson Oaks is pumped to the Weatherford WWTP for treatment. In addition, wastewater generated within the Deer Creek Waterworks WWTP service area (which includes a portion of Annetta and part of the area between Annetta and Annetta South) is collected and transported to the Deer Creek Waterworks WWTP for treatment.

Figure 2-2 shows the location of the four existing WWTPs in the Planning Area. With the exception of the Deer Creek Waterworks WWTP, each of the existing WWTP discharge to the nearest stream shown in Figure 2-2. Currently, the Deer Creek Waterworks WWTP pumps all of its treated effluent to the Split Rail Links and Golf Club for reuse.

Table 2-1 shows detailed information about existing wastewater treatment in the regional planning area, and Table 2-2 shows recent wastewater flowrates as a percentage of existing WWTP treatment capacity. The permit status for each of the Participants with an existing WWTP is described below:

- In 2005, the average flowrate at the Aledo WWTP exceeded 75 percent of the existing treatment capacity for three consecutive months, requiring Aledo to begin engineering and financial planning for expansion and/or upgrade of the wastewater treatment

**Table 2-1  
Existing Wastewater Treatment in the Planning Area**

<b>Political Subdivision</b>	<b>Existing Wastewater Treatment</b>	<b>TPDES Permit Number</b>	<b>Expiration Date</b>	<b>Permitted Flowrate (mgd)</b>	<b>Treatment Capacity (mgd)</b>	<b>Annual Average Flowrate (mgd)</b>	<b>Receiving Water</b>
Aledo	City-owned WWTP	WQ0010847-001	5/1/2006 <sup>10</sup>	0.35	0.35	0.258 <sup>11</sup>	Clear Fork Trinity River
Annetta	Septic systems	N/A	N/A	N/A	N/A	Unknown	Individual leaching fields
Annetta North	Septic systems	N/A	N/A	N/A	N/A	Unknown	Individual leaching fields
Annetta South	Septic systems	N/A	N/A	N/A	N/A	Unknown	Individual leaching fields
Deer Creek Waterworks	WWTP owned by Willow Park	WQ0013759-001	9/1/2006 <sup>12</sup>	0.132	0.106	0.056 <sup>13</sup>	No discharge, effluent reused

---

<sup>10</sup> Aledo has applied to renew the permit and to expand its permitted flowrate to 0.60 mgd. The renewal application is being processed by the Texas Commission on Environmental Quality (TCEQ).

<sup>11</sup> As of January 2007.

<sup>12</sup> Willow Park, which owns the Deer Creek Waterworks system, has applied to renew the permit. The original permit has an interim permitted flowrate of 0.132 mgd and a final permitted flowrate of 0.264 mgd that is contingent on construction of additional treatment facilities. The TCEQ has issued a draft permit based on the renewal application.

<sup>13</sup> Based on reported flows from May 2006 through April 2007. In October 2006, it was discovered that the master meter was out of calibration, and a new master meter was installed. Since that time, reported flows have been a factor of about 5.6 times greater than those previously reported. The average flowrate since the new master meter was installed (October 2006 through April 2007) is 0.084 mgd.

**Table 2-1 Continued  
Existing Wastewater Treatment in the Planning Area**

<b>Political Subdivision</b>	<b>Existing Wastewater Treatment</b>	<b>TPDES Permit Number</b>	<b>Expiration Date</b>	<b>Permitted Flowrate (mgd)</b>	<b>Treatment Capacity (mgd)</b>	<b>Annual Average Flowrate (mgd)</b>	<b>Receiving Water</b>
Fort Worth	Septic systems	N/A	N/A	N/A	N/A	Unknown	Individual leaching fields
Hudson Oaks	Residential septic systems; commercial wastewater pumped to Weatherford	N/A	N/A	N/A	N/A	0.024 <sup>14</sup>	N/A
Weatherford	City-owned WWTP	WQ0010380-001	9/1/2006 <sup>15</sup>	4.5	4.5	2.060 <sup>16</sup>	Town Creek/South Fork Trinity River
Willow Park	City-owned WWTP	WQ0013834-001	9/1/2006 <sup>17</sup>	0.3	0.24	0.096 <sup>18</sup>	Clear Fork Trinity River

---

<sup>14</sup> Annual average flowrate of commercial wastewater pumped to the City of Weatherford WWTP.

<sup>15</sup> Weatherford has applied to renew its permit. The renewal application is being processed by the TCEQ.

<sup>16</sup> As of January 2007.

<sup>17</sup> Willow Park has applied to amend its permit and to expand its permitted flowrate to 1.2 mgd. Willow Park anticipates that the TCEQ will permit a lesser flowrate of 0.6 mgd to 0.9 mgd, contingent upon construction of additional treatment facilities. The application is administratively complete, and the TCEQ is conducting a technical review.

<sup>18</sup> As of April 2007.

**Table 2-2  
Recent Wastewater Flow as a Percentage of Existing WWTP Treatment Capacity**

<b>WWTP</b>	<b>Annual Average</b>	<b>January 2007 Monthly Average</b>
Aledo	74	99
Deer Creek Waterworks	53	106
Weatherford	46	47
Willow Park	40	65

system.<sup>c</sup> Aledo has applied to renew its permit and to expand its permitted flowrate to 0.60 million gallons per day (mgd) and is designing the necessary improvements. The renewal application is being processed by the Texas Commission on Environmental Quality (TCEQ).

- Willow Park, which owns the Deer Creek Waterworks system, has applied to renew the permit for the Deer Creek Waterworks WWTP. The original permit contains an interim permitted flowrate of 0.132 mgd and a final permitted flowrate of 0.264 mgd that is contingent upon construction of additional treatment facilities. The TCEQ has issued a draft permit based on the renewal application. Based on recent high flow rates to the plant, Willow Park has initiated design of additional treatment facilities at the Deer Creek Waterworks WWTP.
  
- Weatherford has applied to renew its permit. The renewal application is being processed by the TCEQ.
  
- To provide capacity to serve a greater portion of its city and to serve potential new development, Willow Park has applied to amend the permit for the Willow Park WWTP and to expand the permitted flowrate to 1.2 mgd. Willow Park anticipates that the TCEQ will permit a flowrate of 0.6 mgd to 0.9 mgd, contingent upon construction of additional treatment facilities. The application is administratively complete, and the TCEQ is conducting a technical review. Willow Park has not initiated design of additional treatment facilities at the Willow Park WWTP.

Average monthly wastewater bills for service of 10,000 gallons in the Planning Area are shown in Table 2-3.

**Table 2-3  
Average Monthly Wastewater Bills in the Planning Area**

City	Average Monthly Wastewater Bill (10,000 gallons Service)	Comment
Aledo	\$33.94	
Hudson Oaks	\$132.00	
Willow Park	\$47.63	Residential
	\$74.50	Commercial
	\$50.00	Deer Creek Waterworks service area
Weatherford	\$49.77	

### 2.3.2 Septic Systems

Wastewater generated in residential areas of Hudson Oaks and most residential areas of Willow Park is treated by septic systems. With the exception of wastewater customers of the Deer Creek Waterworks, wastewater generated in Annetta, Annetta North, Annetta South, and the portion of Fort Worth's ETJ located in the Planning Area is also treated by septic systems. Based on Census population and housing unit data, it is estimated that there are approximately 5,400 septic systems in the Planning Area.

Of the approximately 74,500 acres in the Planning Area, approximately 44,700 acres are located outside the CCN of any existing wastewater treatment provider or are located in unsewered areas. Therefore, it is estimated that at least 60 percent of the acreage in the Planning Area depends on individual septic systems for wastewater treatment.

Septic system design, age, location, operation, and maintenance; soil type; depth to groundwater; and proximity to surface water all influence the pollution potential from septic systems. Poorly designed or malfunctioning septic systems can contribute to the degradation of water quality by discharging excessive nutrients and bacteria that can migrate to groundwater and surface water. Nutrients such as nitrogen and phosphorus can cause excessive algae and plant growth in surface water. Nitrates in groundwater can pose health risks to infants and some adults if consumed. Bacteria, viruses, and protozoans can also pose health risks if human



contact occurs.

## **2.4 PREVIOUS PLANNING EFFORTS**

Several plans for regional wastewater treatment in the Planning Area have been published in the last 20 years. These include a 1988 study conducted for the Tarrant County Water Control and Improvement District Number One (TCWCID #1, now Tarrant Regional Water District), a 1988 plan developed for the Trinity River Authority (TRA), a 2004 plan developed for the Brazos River Authority (BRA) and the Tarrant Regional Water District (TRWD), and 2004 planning by Fort Worth. WWTP locations from these studies were considered in the current planning project.

### **2.4.1 1988 TCWCID #1 Regional Facility Planning Study**

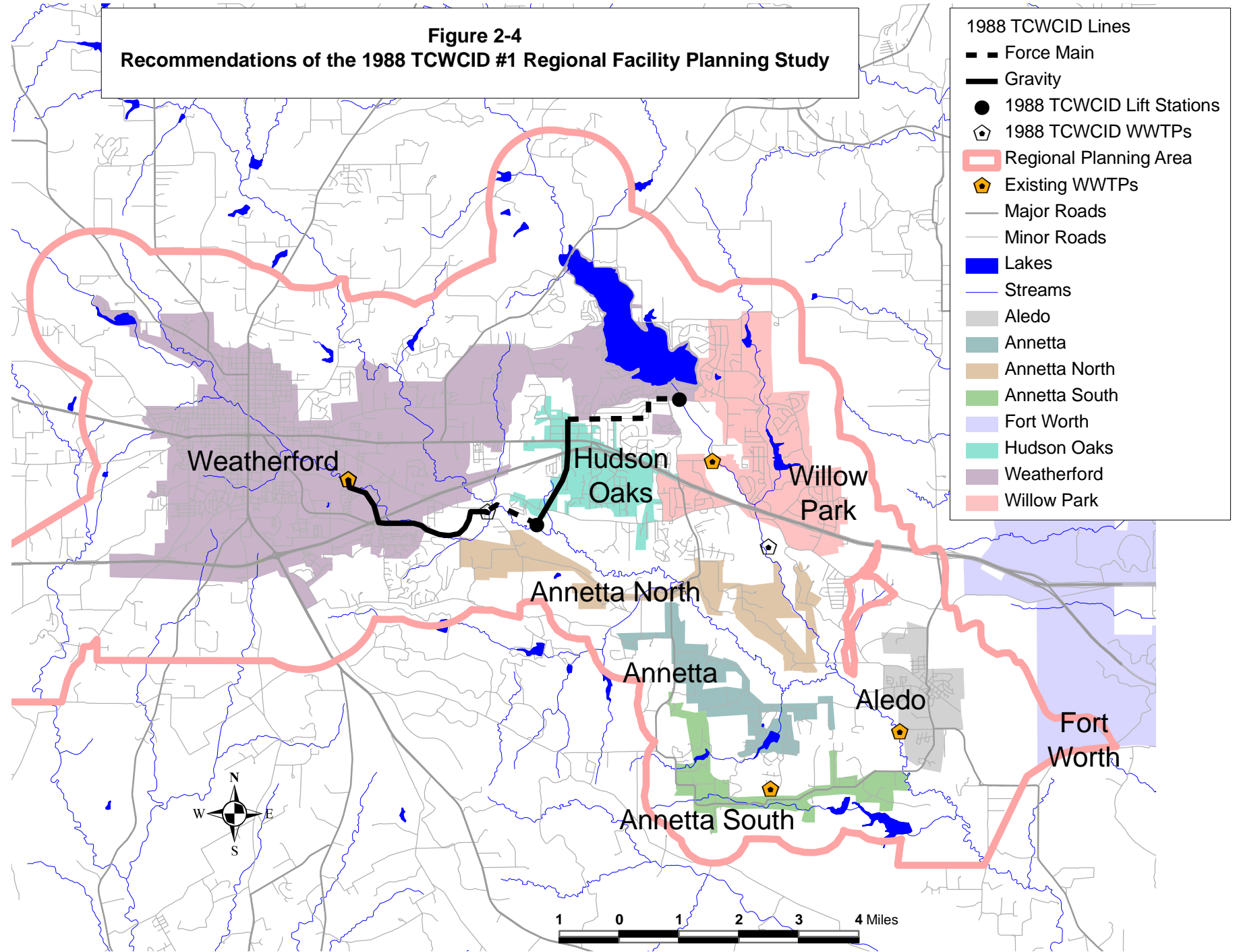
In 1988, TCWCID #1 (now TRWD) conducted a study<sup>d</sup> to identify the wastewater facilities needed to accommodate future population growth and to protect water quality in a 2,725 square mile planning area that includes all of the Upper West Fork Trinity River and Clear Fork Trinity River basins. One subarea, the Clear Fork-Weatherford Facility Planning Region, included Weatherford, Willow Park, Hudson Oaks, Aledo, the Lake Weatherford area, Annetta North, Annetta, and Annetta South.

For each city, the study considered the following wastewater alternatives:

- On-site wastewater disposal systems (septic systems),
- Local organized sewerage systems,
- Subregional sewerage systems, and
- Regional sewerage systems.

The study recommended a regional wastewater system to serve Weatherford, the Lake Weatherford area, and Hudson Oaks. The regional wastewater system (Figure 2-4) would include the existing Weatherford WWTP, a new Center Point WWTP, two lift stations and associated force mains, and a gravity line between the WWTPs. The study reported layouts, treatment units, preliminary sizing, and cost estimates for the recommended facilities.

**Figure 2-4**  
**Recommendations of the 1988 TCWCID #1 Regional Facility Planning Study**



For Willow Park, the study recommended that:

- Construction of organized wastewater collection and treatment systems to serve existing households is not feasible without grant assistance.
- Developers should be required to construct such systems to serve new development.
- The southern portion of the city should be served by a WWTP planned for the Clear Fork Canyon Estates subdivision.

For Annetta, Annetta North, and Annetta South, the study recommended that:

- Construction of organized wastewater collection and treatment systems to serve existing households is not feasible due to high costs.
- The cities should consider requiring developers to construct wastewater collection and treatment systems to serve new development.

Finally, the study recommended that Aledo continue to operate its WWTP and require newly platted subdivisions to connect to the city's wastewater collection system.

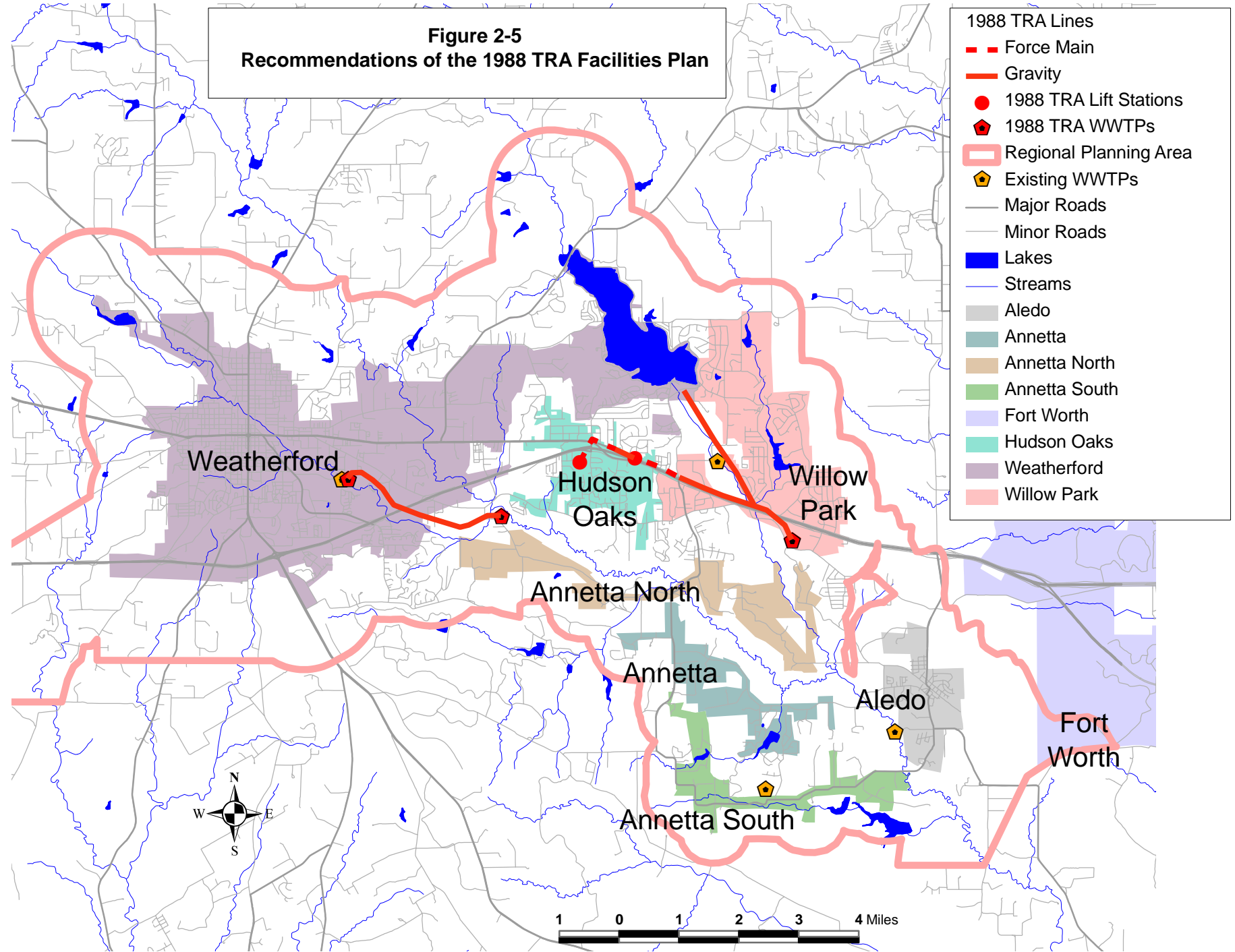
#### **2.4.2 1988 TRA Facilities Plan**

In response to the need for regional wastewater facilities in the area and to the TCWCID #1 study discussed above, TRA developed a regional wastewater facilities plan<sup>e</sup> to serve Weatherford, Hudson Oaks, and Willow Park. During development of the plan, three new WWTP sites were considered in addition to the existing Weatherford WWTP: a Center Point WWTP, a Lake Weatherford WWTP, and a South Willow Park WWTP. After evaluation of a number of potential configurations, the facilities plan recommended a regional system comprised of the following facilities (Figure 2-5):

- The existing Weatherford WWTP to serve the western portion of Weatherford.
- A Center Point WWTP to serve eastern Weatherford and southern Hudson Oaks and to treat excess wastewater flow received at the Weatherford WWTP.
- A South Willow Park WWTP to serve Willow Park, the Lake Weatherford area, and northern Hudson Oaks.
- Two lift stations and three interceptors.

The plan reported layouts, treatment units, preliminary sizing, and cost estimates for the recommended facilities.

**Figure 2-5**  
**Recommendations of the 1988 TRA Facilities Plan**



### **2.4.3 2003 Weatherford Planning**

In 2003, Weatherford conducted a feasibility study for a potential Sanchez Creek WWTP that would be located in far southwest Weatherford (Figure 2-6).<sup>f</sup> The study compared the relative costs of providing wastewater treatment with a new WWTP and providing wastewater treatment by pumping wastewater from the Sanchez Creek Basin to the existing WWTP. The study recommended that:

- Although a Sanchez Creek WWTP would not be feasible for at least 10 years, given projected population growth and density, Weatherford should consider acquiring a site for the plant.
- Weatherford should continue to pump wastewater from the Sanchez Creek Basin to the existing WWTP.
- Weatherford should upgrade its existing WWTP to meet capacity needs.

Since completion of this study, Weatherford has made improvements to its Sanchez Creek Basin lift stations and upgraded its existing WWTP. Weatherford has not acquired a site for the Sanchez Creek WWTP.

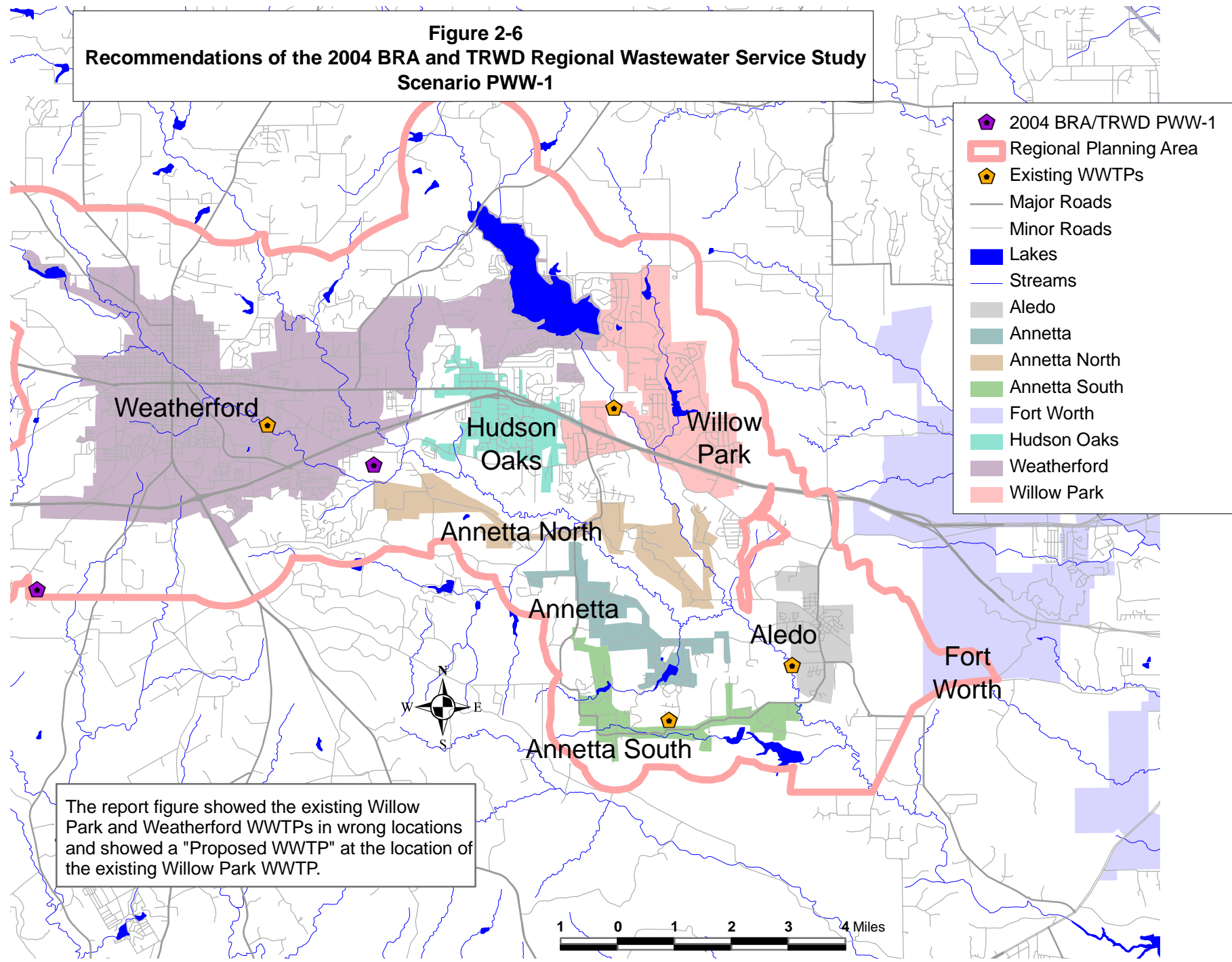
### **2.4.4 2004 BRA and TRWD Regional Wastewater Service Study**

In 2004, BRA and TRWD conducted a regional water and wastewater service study for Johnson and Parker Counties.<sup>9</sup> The study suggested two potentially feasible regional wastewater systems in Parker County but did not perform a detailed evaluation or report layouts, treatment units, preliminary sizing, or cost estimates. Each of the potentially feasible systems is described below.

#### **2.4.4.1 Scenario PWW-1**

Scenario PWW-1 involves construction of three new plants to supplement Weatherford's existing WWTP: a Sanchez Creek WWTP in far southwest Weatherford, a Willow Creek WWTP just east of the main part of Weatherford, and a Lake Weatherford WWTP (Figure 2-6). These new WWTPs would reduce the amount of wastewater that would have to be pumped to the existing WWTP. This scenario assumes that other entities in the east central part of Parker County would eventually be served by the Fort Worth.

**Figure 2-6**  
**Recommendations of the 2004 BRA and TRWD Regional Wastewater Service Study**  
**Scenario PWW-1**



The report figure showed the existing Willow Park and Weatherford WWTPs in wrong locations and showed a "Proposed WWTP" at the location of the existing Willow Park WWTP.

#### **2.4.5 Scenario PWW-2**

This scenario is the same as Scenario PWW-1, except that a Bear Creek WWTP is proposed to serve Aledo, Annetta, Annetta North, Annetta South, Willow Park and the Lake Weatherford area (Figure 2-7).

#### **2.4.6 2004 Fort Worth Planning**

In 2004, Fort Worth conducted preliminary planning for a potential water recycling center (WRC) in the Mary's Creek watershed, which is adjacent to the Clear Fork Trinity River watershed (Figure 2-8). The WRC project would involve diverting wastewater from nearby interceptors, treating the wastewater, and providing reclaimed water for non-potable use. At the time, Fort Worth and Aledo discussed the possibility of treating all or part of Aledo's wastewater at a Mary's Creek WRC. The flow projections for the Mary's Creek WRC included all of Aledo's wastewater and all flow from the Walsh Ranch area of Fort Worth.

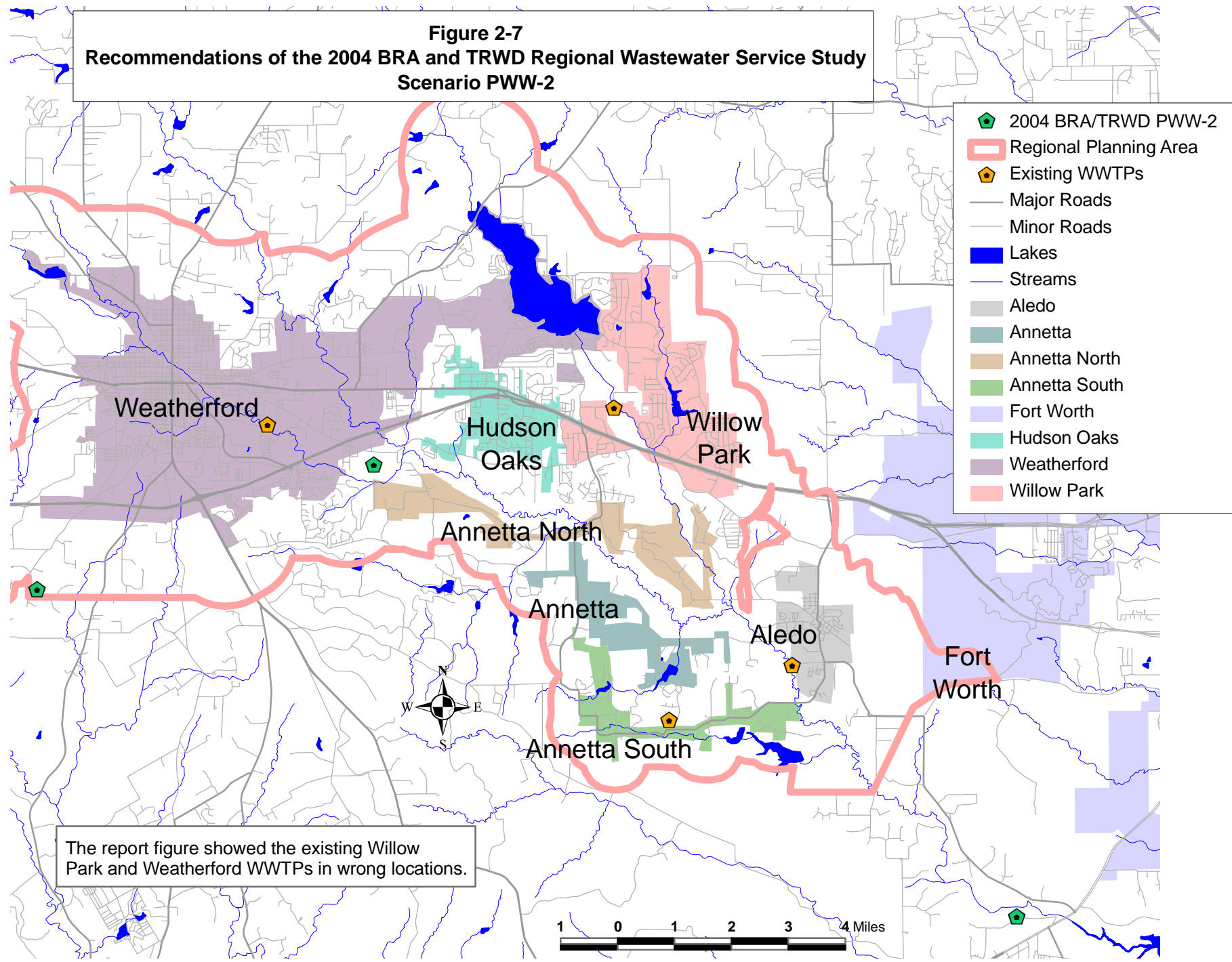
### **2.5 CURRENT PLANNING**

The current planning project considered regional wastewater treatment facilities to provide wastewater service to Aledo, Annetta, Annetta North, Annetta South, part of Fort Worth, Hudson Oaks, Willow Park, and Weatherford. The project identified infrastructure improvements through 2030 that are necessary to implement a regional wastewater treatment system. 2030 was chosen as the end of the planning period because it is the last year for which certain population projections are available. Key decisions on how to configure and implement a regional wastewater system must be made prior to 2030, so the choice of 2030 as the end of the planning period will not impact these decisions. Additional infrastructure improvements will be necessary beyond 2030, but these improvements were not included in this report.

The scope of work included the following tasks:

- Define population and wastewater flow projections for the potential customers.
- Develop probable influent wastewater quality characteristics.
- Develop a water conservation plan for those entities that do not already have a TWDB-approved water conservation plan.
- Develop a conceptual design for a regional collection system.
- Define probable effluent water quality criteria.

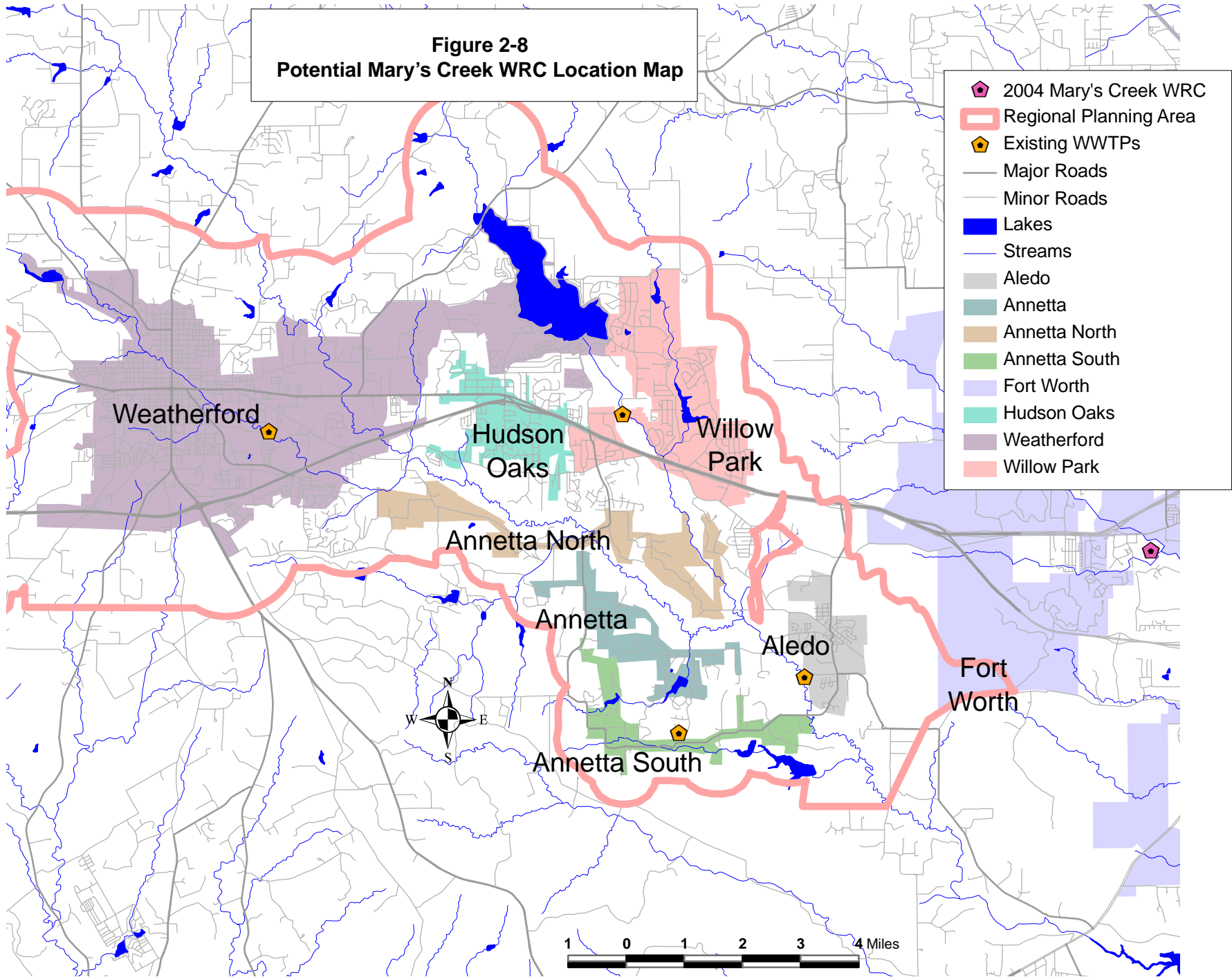
**Figure 2-7**  
**Recommendations of the 2004 BRA and TRWD Regional Wastewater Service Study**  
**Scenario PWW-2**



The report figure showed the existing Willow Park and Weatherford WWTPs in wrong locations.



**Figure 2-8**  
**Potential Mary's Creek WRC Location Map**



- Develop conceptual designs for one or more regional WWTPs.
- Develop opinions of probable cost for operation and maintenance and capital expenditures.
- Identify potential reclaimed water users.
- Conduct three public meetings to seek public input (see meeting summaries in Appendix E).

Population projections, wastewater flow projections, site selection for analysis of regional wastewater facilities, conceptual design of a regional collection system, probable effluent water quality criteria, recommended wastewater treatment processes, conceptual design of regional wastewater treatment facilities, and an implementation plan are discussed in later chapters.

## CHAPTER 3

### POPULATION AND WASTEWATER FLOW PROJECTIONS

To plan for regional wastewater treatment facilities, it is necessary to project the amount of wastewater flow contributed by each Participant. For a given Participant, the projected wastewater flow is the product of the projected population and the projected per capita wastewater flow. The projected wastewater flow for each Participant is presented in this chapter.

#### 3.1 PROJECTED POPULATION

Population projections were developed by city/CCN and by sewershed. Each set of projections is discussed below.

##### 3.1.1 By City/CCN

Historical and projected populations were obtained (where available) from the Participants, the Texas Water Development Board<sup>h</sup> (TWDB), the North Central Texas Council of Governments<sup>i,j,k,l,m,n</sup> (NCTCOG), and the U.S. Census Bureau.<sup>o</sup> In consultation with the Participants, a single population projection was selected for use in developing the regional wastewater facilities plan. The sum of the selected population projections is shown in Table 3-1. All available population projections for each Participant are presented in Appendix A.

For most cities, the selected population projection is the TWDB population projection or is derived from the TWDB population projection. There are three exceptions: Aledo, Willow Park, and Deer Creek Waterworks. The TWDB projections for Aledo and Willow Park show smaller growth rates than for cities to their east (Fort Worth in Parker County) and to their west (Hudson Oaks). Since Fort Worth is a primary economic driver for population growth in the Planning Region, it makes sense that population growth will move westward from Fort Worth and that Aledo and Willow Park will grow as rapidly as their neighbors. The selected population projection for Aledo was developed by Belcheff Associates, Inc. This projection better corresponds to the 2005 U.S. Census Bureau population estimate than the other projections and is the projection that Aledo is using in its own planning work. For Willow Park, the selected population projection is the NCTCOG projection.

**Table 3-1  
Projected Population by City/CCN**

<b>City/CCN</b>	<b>2000</b>	<b>2010</b>	<b>2020</b>	<b>2030</b>
Aledo <sup>p</sup>	1,726	4,110	7,940	11,769
Annetta <sup>h</sup>	1,108	1,579	1,972	2,289
Annetta North <sup>19</sup>	467	666	832	966
Annetta South <sup>h</sup>	555	708	836	939
Fort Worth (Planning Area) <sup>20</sup>	0	1,331	5,766	8,870
Hudson Oaks <sup>h</sup>	1,637	2,960	4,262	5,673
Weatherford <sup>h</sup>	19,000	25,412	32,161	38,365
Willow Park <sup>i</sup>	2,849	3,211	6,187	13,631
Deer Creek Waterworks <sup>21</sup>	200	275	338	388
<b>Total</b>	<b>27,542</b>	<b>40,252</b>	<b>60,294</b>	<b>82,890</b>

Population projections for the Deer Creek Waterworks CCN were not available. Part of this population is included in the projections for Annetta. The remainder of the population for the Deer Creek Waterworks CCN was estimated based on existing flows to the Deer Creek Waterworks WWTP and was assumed to grow at the average growth rate for Annetta and Annetta South during the planning period (Table 3-1).

### 3.1.2 **By Sewershed**

The selected population projections for each city were further subdivided into sewersheds<sup>22</sup> to allow projection of the wastewater flow from each sewershed. This information will be important in the selection of recommended regional wastewater treatment plant sites and in the conceptual design of a regional collection system discussed later in this report. Figure 3-1 shows the division of each city into sewersheds. The sewersheds were named after an existing

---

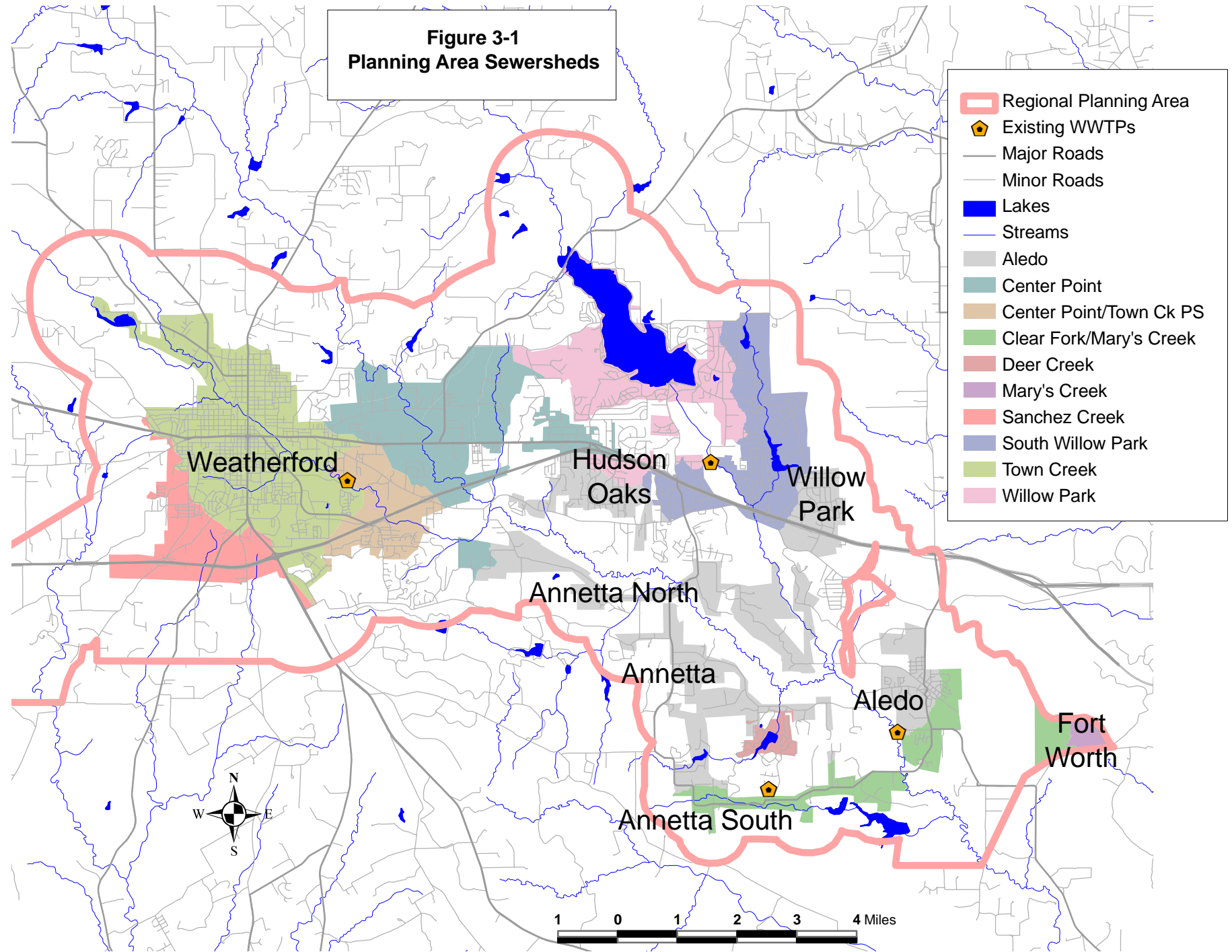
<sup>19</sup> No population projections were available. Therefore, the population was projected forward from the 2000 Census population using the same population growth rate as Annetta.

<sup>20</sup> TWDB projections were available for the portion of Fort Worth that is located in Parker County. The population projection for the portion of Fort Worth that is located in the Planning Area was pro-rated from these projections by the respective land areas.

<sup>21</sup> The projected population for the Deer Creek Waterworks CCN represents the portion that is not included in the projections for Annetta.

<sup>22</sup> Areas from which wastewater drains by gravity flow.

**Figure 3-1  
Planning Area Sewersheds**



or proposed WWTP or a lift station site to which wastewater can flow by gravity.<sup>23</sup>

Each city's population was distributed to sewersheds using relative population densities, starting with population densities from the 2000 Census. It was assumed that the sewersheds with the highest population densities would continue to grow in the future but that sewersheds with the lowest population densities would grow more rapidly. Table 3-2 shows the projected population for each sewershed.

### **3.2 PROJECTED ANNUAL AVERAGE PER CAPITA WASTEWATER FLOW**

Per capita wastewater flow was projected using the historical per capita wastewater flow as described below.

#### **3.2.1 Historical Annual Average Per Capita Wastewater Flow**

For each Participant, the historical annual average per capita wastewater flow was estimated from historical wastewater flow data and/or from historical water use data.

##### **3.2.1.1 Estimated from Wastewater Data**

For Participants with WWTPs, historical wastewater discharges were obtained from the Participants and the U.S. Environmental Protection Agency<sup>d</sup> (EPA). Where data were available, the historical discharge was divided by the historical population to obtain the estimated historical annual average per capita wastewater flow (Table 3-3).

The estimated historical annual average per capita wastewater flow for Fort Worth has not been reported because the data represent flow from more than just Fort Worth (it includes flow from several wholesale customer cities) and because this flow was not generated in the Planning Area. Population data were not available for the portion of Willow Park served by the Willow Park WWTP nor for the Deer Creek Waterworks WWTP service area, so historical annual average per capita wastewater flow could not be estimated for these areas.

---

<sup>23</sup> Wastewater will not necessarily be treated at these locations. Wastewater treatment locations are discussed in later chapters.

**Table 3-2  
Projected Population by Sewershed**

<b>City/CCN</b>	<b>Sewershed Name</b>	<b>2000</b>	<b>2010</b>	<b>2020</b>	<b>2030</b>
Aledo	Aledo	1,123	2,250	4,061	5,871
	Clear Fork	603	1,860	3,879	5,898
Annetta	Aledo	644	918	1,146	1,330
	Deer Creek	464	661	826	959
Annetta North	Aledo	445	635	793	921
	Center Point	22	31	39	45
Annetta South	Aledo	130	166	196	220
	Clear Fork	425	542	640	719
Fort Worth (Planning Area)	Clear Fork	0	799	3,463	5,328
	Mary's Creek	0	532	2,303	3,542
Hudson Oaks	Aledo	1,015	1,835	2,642	3,517
	Center Point	341	616	888	1,182
	South Willow Park	40	73	105	140
	Willow Park	241	435	627	834
Weatherford	Weatherford	15,291	19,084	23,077	26,748
	Lift Station 14	931	1,642	2,389	3,077
	Lift Station 9	1,069	1,492	1,937	2,346
	Lift Station 16	210	257	305	350
	Lift Station 15	93	263	441	605
	Lift Station 17	1,258	2,292	3,380	4,379
	Lift Station 20	147	383	631	859
Willow Park	Aledo	462	520	1,001	2,205
	South Willow Park	1,758	1,979	3,812	8,399
	Willow Park	633	713	1,374	3,026
Deer Creek Waterworks <sup>24</sup>	Deer Creek	200	275	338	388
<b>Total</b>		<b>27,542</b>	<b>40,252</b>	<b>60,294</b>	<b>82,890</b>

<sup>24</sup> The projected population for the Deer Creek Waterworks CCN represents the portion that is not included in the projections for Annetta.

**Table 3-3  
Estimated Historical and Projected Annual Average Per Capita Wastewater Flows (gpcd)**

City	From Wastewater Data <sup>25</sup>					From Water Use Data <sup>25</sup>			Projected
	2002	2003	2004	2005	2006	2002	2003	2004	
Aledo	120	102	118	102	99	98	99	94	120 <sup>26</sup>
Annetta						72	71	71	100
Annetta North									100
Annetta South						75	75	75	100
Fort Worth						133	115	115	120
Hudson Oaks						71	114	114	120
Weatherford	105	109	106	91	83	118	118	108	120
Willow Park						81	81	82	100

**3.2.1.2 Estimated from Water Use Data**

For Participants without WWTPs, annual average per capita wastewater flow was estimated from TWDB historical water use data.<sup>†</sup> It was assumed that 65 percent of the historical water use represents wastewater that would be returned to a treatment system. The estimated return flow was divided by the historical population to obtain an estimated historical annual average per capita wastewater flow for each Participant (Table 3-3).

**3.2.2 Projected Annual Average Per Capita Wastewater Flow**

For Fort Worth, Hudson Oaks, and Weatherford, the projected annual average per capita wastewater flows (Table 3-3) are 120 gallons per capita per day (gpcd). These projections are generally based on the maximum of the per capita wastewater flows estimated from wastewater and water use data. Although the estimate from 2002 Fort Worth water use indicates that annual average wastewater flow could be as high as 133 gpcd, the water use data do not necessarily represent water use in the Planning Area, because the Fort Worth portion of the Planning Area is undeveloped. Therefore, it was assumed that the portion of Fort Worth in the Planning Area would have similar per capita wastewater flows to other developed cities in the Planning Area.

---

<sup>25</sup> Representative data not available for all cities.

<sup>26</sup> See discussion in Section 3.2.2.



As discussed in Chapter 2, the annual average flow to the Aledo WWTP as of January 2007 is 74 percent of the permitted treatment capacity. Although design of improvements to the Aledo WWTP is in progress, it has been assumed that Aledo will manage future wastewater flows and operate its WWTP without expansion until it can connect to the first phase of a regional wastewater system. Management of future flows, through control of infiltration and inflow and by limiting new wastewater service, would delay some of the projected growth in wastewater flows until after Aledo has connected to a regional wastewater system. Therefore, although previous wastewater data justify an annual average per capita wastewater flow of 120 gpcd, it has been assumed that this will not occur until after Aledo connects to a regional wastewater system.

For Annetta, Annetta South, and Willow Park, annual average per capita wastewater flows estimated from water use data were well below 100 gpcd. It is anticipated that a regional wastewater system would support denser development, which may be accompanied by increasing water use and wastewater flows. Therefore, for planning purposes, the projected annual average per capita wastewater flow for these cities is 100 gpcd. Although no data were available for Annetta North or the Deer Creek Waterworks CCN, it was assumed that annual average per capita wastewater flow from Annetta North and the Deer Creek Waterworks CCN will also be 100 gpcd.

### **3.3 PROJECTED ANNUAL AVERAGE WASTEWATER FLOW**

For each Participant, the projected annual average wastewater flow was obtained by multiplying the projected population and the projected annual average per capita wastewater flow. Annual average wastewater flows were projected by city/CCN (Table 3-4) and by city/CCN and sewershed (Table 3-5).

As discussed in Section 3.2.2, it has been assumed that some of the projected growth in Aledo's wastewater flow will be delayed until Aledo connects to a regional wastewater system. After Aledo connects to a regional wastewater system, it has been assumed that the projected wastewater flow will gradually increase through 2060 to equal 120 gpcd times the projected population.

**Table 3-4  
Projected Annual Average Wastewater Flow by City/CCN (mgd)**

<b>City/CCN</b>	<b>2010</b>	<b>2020</b>	<b>2030</b>
Aledo	0.29	0.75	1.26
Annetta	0.16	0.20	0.23
Annetta North	0.07	0.08	0.10
Annetta South	0.07	0.08	0.09
Fort Worth (Planning Area)	0.16	0.69	1.06
Hudson Oaks	0.36	0.51	0.68
Weatherford	3.05	3.86	4.60
Willow Park	0.32	0.62	1.36
Deer Creek Waterworks <sup>27</sup>	0.03	0.03	0.04
<b>Total</b>	<b>4.50</b>	<b>6.83</b>	<b>9.43</b>

---

<sup>27</sup> The projected flow for the Deer Creek Waterworks CCN represents the portion that is not included in the projection for Annetta.

**Table 3-5  
Projected Annual Average Wastewater Flow by City and Sewershed (mgd)**

<b>City</b>	<b>Sewershed Name</b>	<b>2010</b>	<b>2020</b>	<b>2030</b>
Aledo	Aledo	0.160	0.385	0.630
	Clear Fork	0.132	0.368	0.633
Annetta	Aledo	0.092	0.115	0.133
	Deer Creek	0.066	0.083	0.096
Annetta North	Aledo	0.063	0.079	0.092
	Center Point	0.003	0.004	0.004
Annetta South	Aledo	0.017	0.020	0.022
	Clear Fork	0.054	0.064	0.072
Fort Worth (Planning Area)	Clear Fork	0.096	0.416	0.639
	Mary's Creek	0.064	0.276	0.425
Hudson Oaks	Aledo	0.220	0.317	0.422
	Center Point	0.074	0.107	0.142
	South Willow Park	0.009	0.013	0.017
	Willow Park	0.052	0.075	0.100
Weatherford	Weatherford	2.290	2.769	3.210
	Lift Station 14	0.197	0.287	0.369
	Lift Station 9	0.179	0.232	0.282
	Lift Station 16	0.031	0.037	0.042
	Lift Station 15	0.032	0.053	0.073
	Lift Station 17	0.275	0.406	0.526
	Lift Station 20	0.046	0.076	0.103
Willow Park	Aledo	0.052	0.100	0.221
	South Willow Park	0.198	0.381	0.840
	Willow Park	0.071	0.137	0.303
Deer Creek Waterworks <sup>28</sup>	Deer Creek	0.028	0.034	0.039
<b>Total</b>		<b>4.50</b>	<b>6.83</b>	<b>9.43</b>

<sup>28</sup> The projected flow for the Deer Creek Waterworks CCN represents the portion that is not included in the projection for Annetta.

## **CHAPTER 4**

### **SITE SELECTION FOR ANALYSIS OF REGIONAL WASTEWATER TREATMENT FACILITIES**

Four potential regional WWTP sites were selected for analysis after consideration of WWTP sites that were recommended in previous studies and through recommendations from the Participants. These sites represent general areas and do not represent any particular individual properties. The location of each site selected for further analysis is described below and shown in Figure 4-1. The arrow in Figure 4-1 between the Clear Fork WWTP site and the proposed Fort Worth Mary's Creek Water Recycling Center site indicates the potential for beneficial interaction between these sites.

The potential sites are distributed along major streams throughout the regional planning area and allow consideration of regional wastewater system configurations ranging from a single regional system to as many as four separate regional systems.

#### **4.1 CENTER POINT WWTP SITE**

The Center Point WWTP site is located east of Weatherford near the intersection of Annetta-Center Point Road and East Bankhead Highway, near the confluence of Town Creek, Willow Creek, and the South Fork Trinity River. A Center Point WWTP would discharge treated effluent to the South Fork Trinity River.




















#### **4.2 SOUTH WILLOW PARK WWTP SITE**

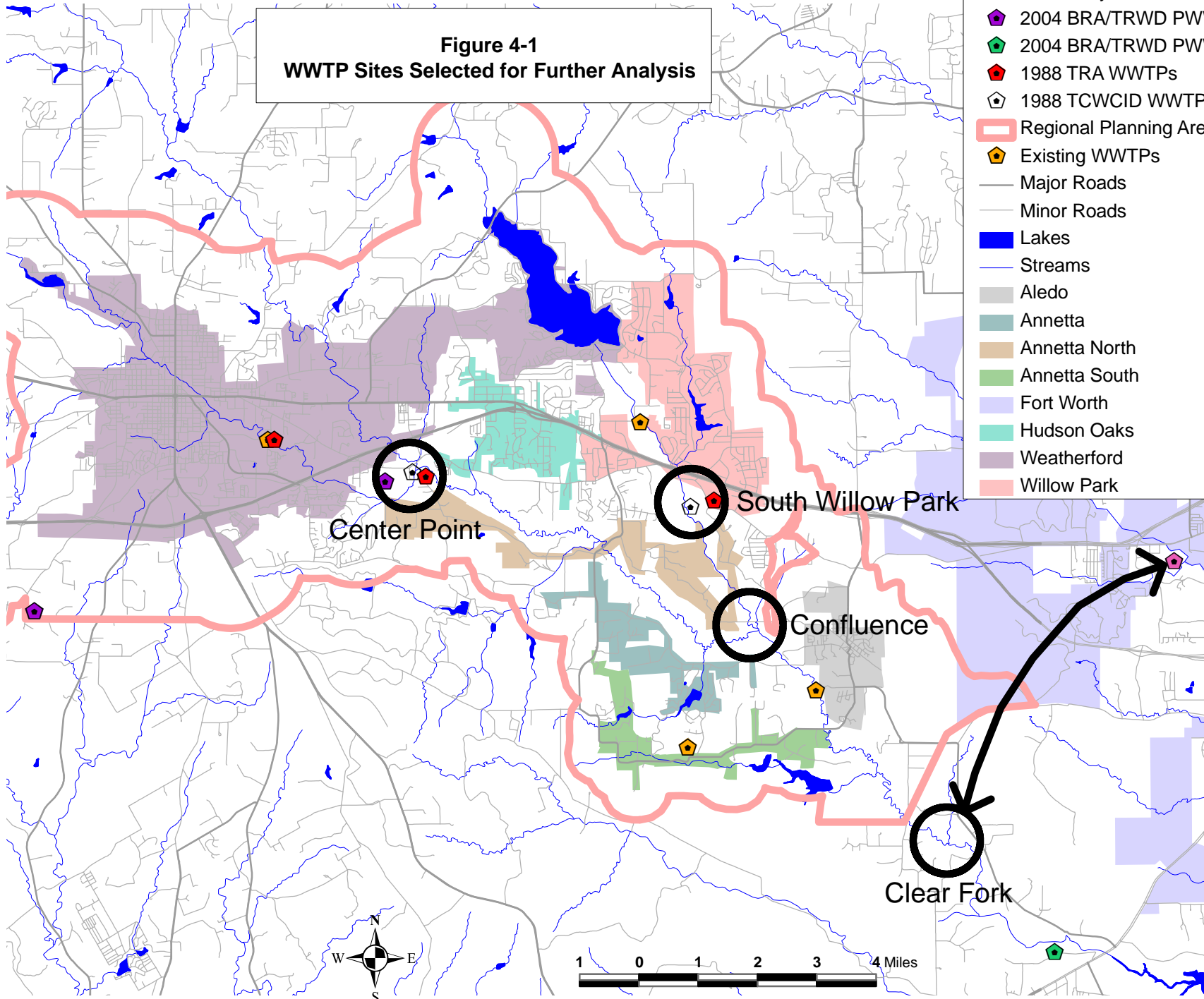
The South Willow Park WWTP site is located south of Willow Park and south of the intersection of Bankhead Highway and the Clear Fork Trinity River. A South Willow Park WWTP would discharge treated effluent to the Clear Fork Trinity River.

#### **4.3 CONFLUENCE WWTP SITE**

The Confluence WWTP site is located west of Aledo near the confluence of the South Fork Trinity River and the Clear Fork Trinity River. A Confluence WWTP would discharge treated effluent to the Clear Fork Trinity River.

**Figure 4-1  
WWTP Sites Selected for Further Analysis**

-  2004 Mary's Creek WRC
-  2004 BRA/TRWD PWW-1
-  2004 BRA/TRWD PWW-2
-  1988 TRA WWTPs
-  1988 TCWCID WWTPs
-  Regional Planning Area
-  Existing WWTPs
-  Major Roads
-  Minor Roads
-  Lakes
-  Streams
-  Aledo
-  Annetta
-  Annetta North
-  Annetta South
-  Fort Worth
-  Hudson Oaks
-  Weatherford
-  Willow Park



#### **4.4 CLEAR FORK WWTP SITE**

The Clear Fork WWTP site is located along the Clear Fork Trinity River just downstream of the Planning Area. A Clear Fork WWTP would discharge treated effluent to the Clear Fork Trinity River. The potential for beneficial interaction with the proposed Fort Worth Mary's Creek WRC site will be considered in the analysis.

## **CHAPTER 5**

### **CONCEPTUAL DESIGN FOR REGIONAL COLLECTION SYSTEM**

After selection of potential regional WWTP sites, a preliminary conceptual design was developed for a regional collection system to transport wastewater from each sewershed to each potential regional WWTP site. To locate and quantify the wastewater flow entering the regional collection system, primary wastewater collection points were identified for each sewershed. An optimization method was used to identify a 2030 system configuration<sup>29</sup> that will minimize capital and operating costs. After consideration of alternative configurations, the lowest-cost 2030 configuration was used as a 2030 target for a regional wastewater system, and an implementation plan was developed to transition wastewater treatment in the Planning Area from current conditions toward this target.

#### **5.1 PRELIMINARY REGIONAL COLLECTION SYSTEMS**

A primary wastewater collection point was identified at the outlet to each Planning Area sewershed. These are the locations where wastewater will enter the regional collection system. The 25 primary wastewater collection points are shown in Figure 5-1.

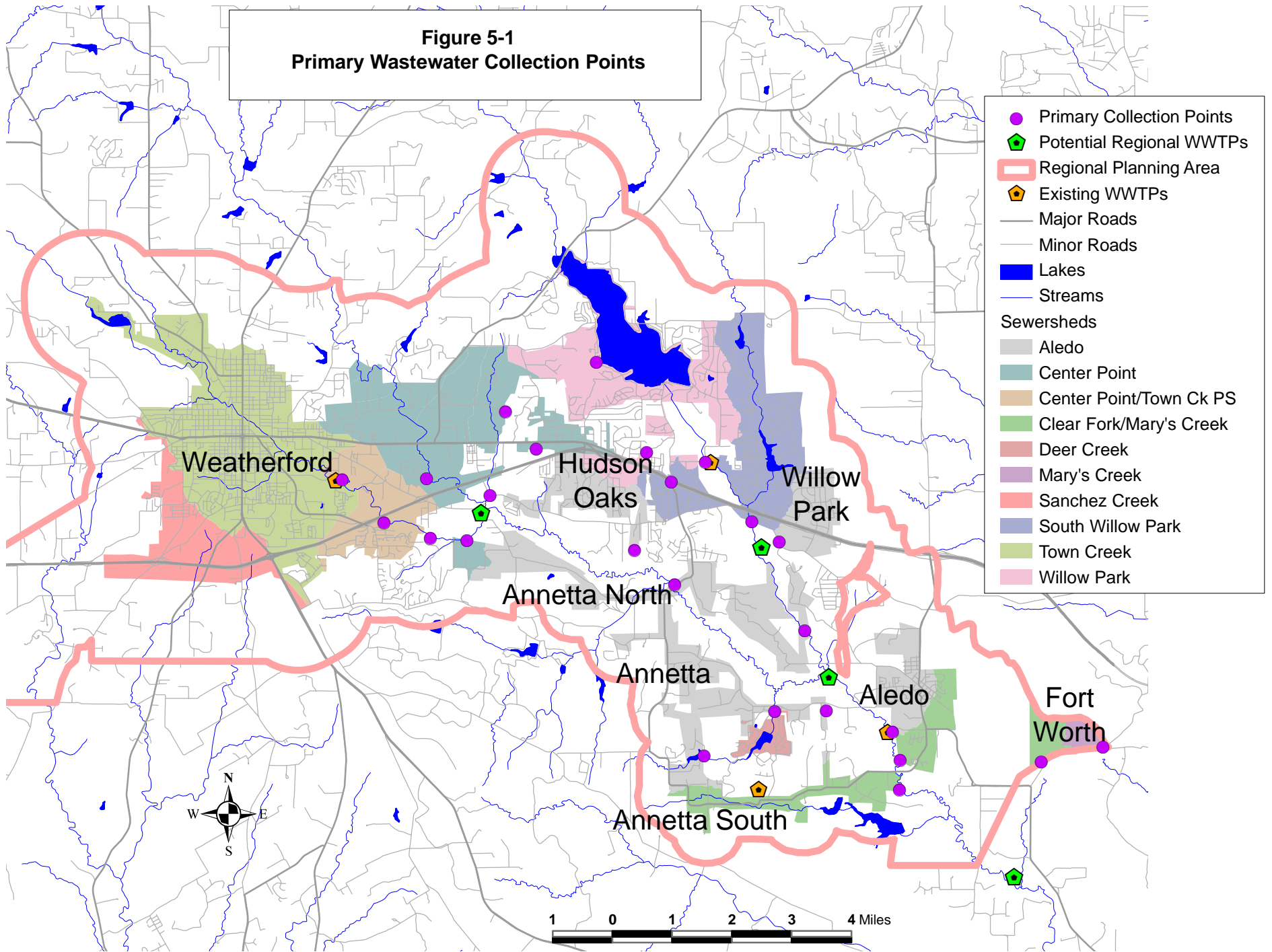
A system of potential regional interceptors was developed to transport flow from each primary wastewater collection point to each potential regional WWTP site (Figure 5-2). In some cases, there are multiple potential routes. The potential regional interceptors generally follow streams so flow can be conveyed by gravity wherever possible.

Several of the primary wastewater collection points in Weatherford are already connected to the Weatherford WWTP through existing interceptors and force mains. Weatherford provided the locations and sizes of these lines (Figure 5-3). Hudson Oaks provided the location of the existing interceptor that connects the Center Point sewershed in Hudson Oaks to the Weatherford collection system.

---

<sup>29</sup> Based only on 2030 conditions without considering implementation issues.

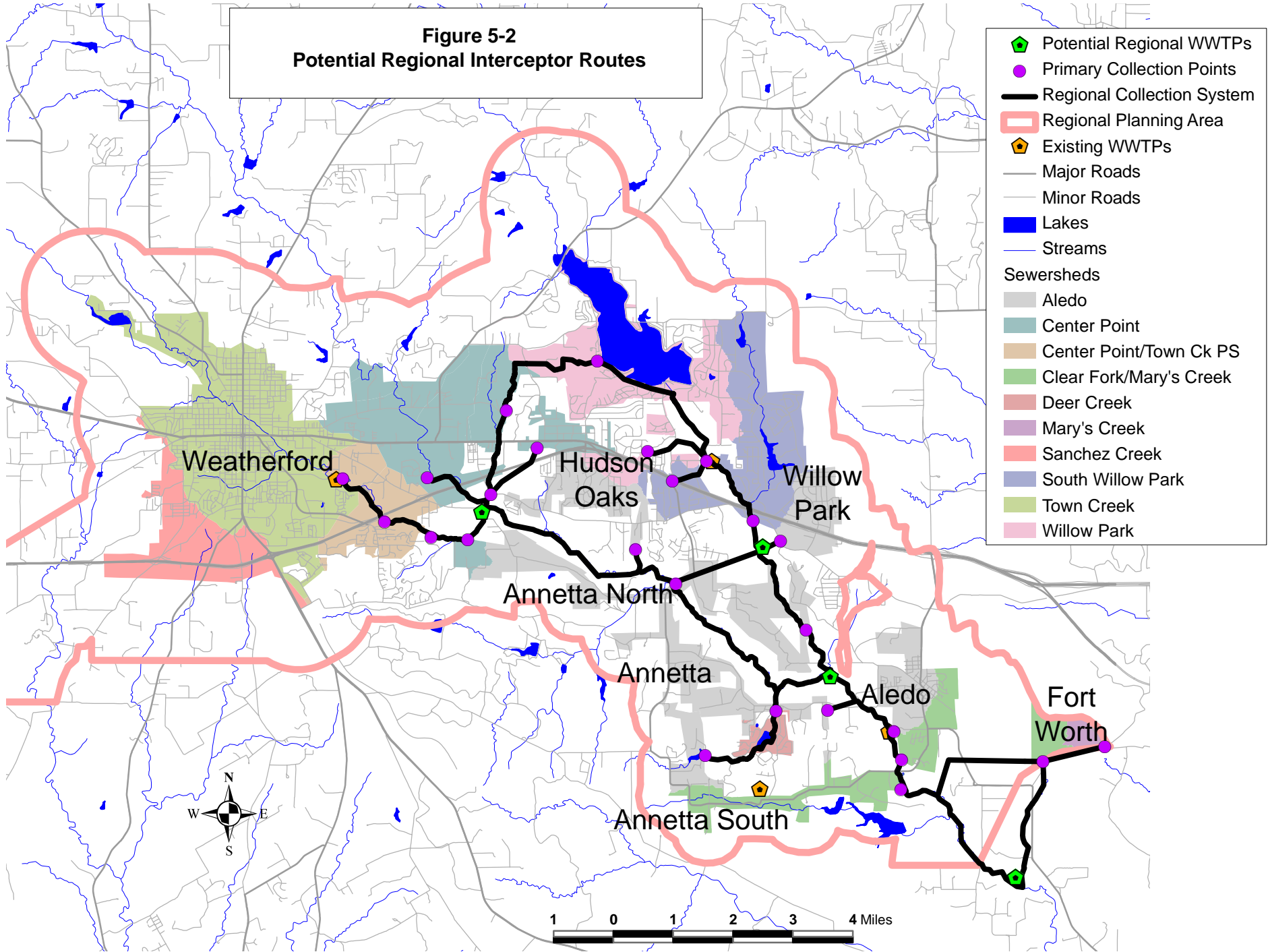
**Figure 5-1  
Primary Wastewater Collection Points**



- Primary Collection Points
- ⬠ Potential Regional WWTPs
- Regional Planning Area
- ⬠ Existing WWTPs
- Major Roads
- Minor Roads
- Lakes
- Streams
- Sewersheds**
- Aledo
- Center Point
- Center Point/Town Ck PS
- Clear Fork/Mary's Creek
- Deer Creek
- Mary's Creek
- Sanchez Creek
- South Willow Park
- Town Creek
- Willow Park

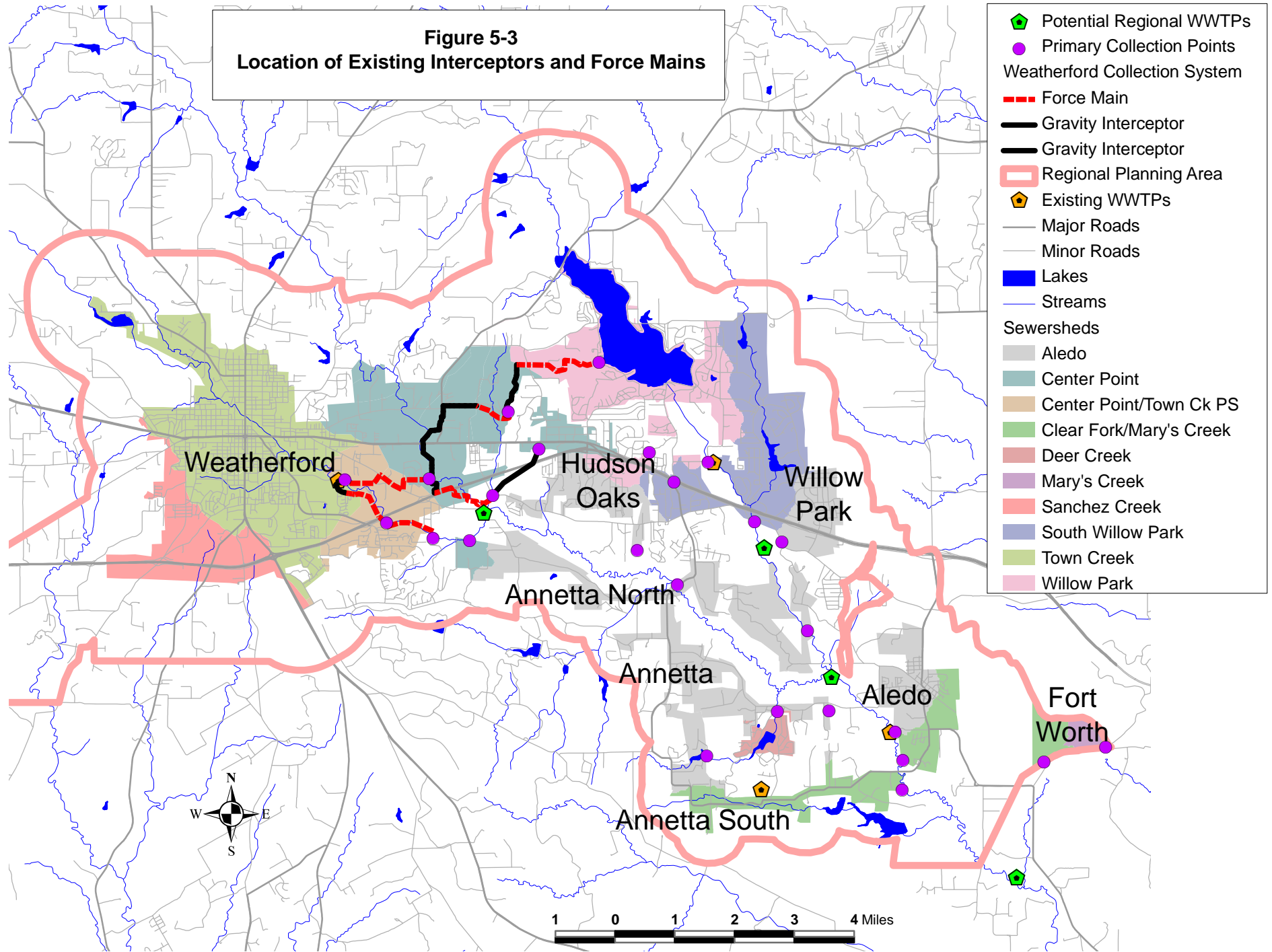


**Figure 5-2**  
**Potential Regional Interceptor Routes**



- Potential Regional WWTPs
- Primary Collection Points
- Regional Collection System
- Regional Planning Area
- Existing WWTPs
- Major Roads
- Minor Roads
- Lakes
- Streams
- Sewersheds**
- Aledo
- Center Point
- Center Point/Town Ck PS
- Clear Fork/Mary's Creek
- Deer Creek
- Mary's Creek
- Sanchez Creek
- South Willow Park
- Town Creek
- Willow Park

**Figure 5-3**  
**Location of Existing Interceptors and Force Mains**



Design spreadsheets were developed to assist in assigning flows from primary wastewater collection points to treatment locations and to assist in sizing of interceptors, force mains, pump stations, and WWTPs for each preliminary regional collection system.<sup>30</sup> Interceptors, force mains, and pump stations were sized to meet projected 2030 peak flows. Few data were available regarding actual current peak flows,<sup>31</sup> so it was assumed that the peak flow would be four times the annual average projected flow.<sup>a</sup> In addition, regional WWTPs and existing WWTPs were sized to serve projected 2030 annual average wastewater flows according to the configuration of the regional collection system. Maximum use was made of existing interceptors and force mains. Key assumptions in the design spreadsheets are discussed in Appendix B.

## **5.2 ANALYSIS OF PRELIMINARY REGIONAL COLLECTION SYSTEMS**

The regional collection system can be configured in a vast number of ways, depending on where the wastewater is treated. Each of the 25 primary collection points could contribute flow to one of four potential regional WWTPs, 15 of the primary collection points could contribute flow to an existing WWTP, and each of the existing WWTPs could be expanded. The matrix of potential wastewater treatment locations by sewershed is shown in Table 5-1.

Preliminary opinions of probable cost were compared for different configurations to identify the lowest-cost configuration that is sized to treat projected 2030 wastewater flows. The procedures for evaluating a single configuration and for comparing different configurations are discussed in the following sections.

### **5.2.1 Evaluation of a Single Configuration**

To evaluate a single configuration of the regional collection system, wastewater flow from each primary wastewater collection point was assigned to an existing WWTP or a regional WWTP. This assignment determines what interceptors, force mains, and pump stations are needed to convey the wastewater to the assigned WWTPs.

---

<sup>30</sup> The slopes of interceptors and force mains were assumed from available topographic data. In addition, it was assumed that peak flows at the regional collection points occur simultaneously and that the peak flow at a downstream location equals the sum of the peak flows introduced at the upstream regional collection points.

<sup>31</sup> Most of the Participants do not have a collection system in the Planning Area.

**Table 5-1  
Potential Wastewater Treatment Locations by Sewershed**

City	Sewershed Name	Existing WWTPs				Proposed Regional WWTP Sites			
		Weatherford	Willow Park	Deer Creek Waterworks	Aledo	Center Point	South Willow Park	Confluence	Clear Fork
Aledo	Aledo				x	x	x	x	x
	Clear Fork				x	x	x	x	x
Annetta	Aledo					x	x	x	x
	Deer Creek			x		x	x	x	x
Annetta North	Aledo					x	x	x	x
	Center Point	x				x	x	x	x
Annetta South	Aledo					x	x	x	x
	Clear Fork					x	x	x	x
Fort Worth (Planning Area)	Clear Fork					x	x	x	x
	Mary's Creek					x	x	x	x
Hudson Oaks	Aledo					x	x	x	x
	Center Point	x				x	x	x	x
	South Willow Park					x	x	x	x
	Willow Park					x	x	x	x
Weatherford	Weatherford	x				x	x	x	x
	Lift Station 14	x				x	x	x	x
	Lift Station 9	x				x	x	x	x
	Lift Station 16	x				x	x	x	x
	Lift Station 15	x				x	x	x	x
	Lift Station 17	x				x	x	x	x
	Lift Station 20	x				x	x	x	x
Willow Park	Aledo		x			x	x	x	x
	South Willow Park		x			x	x	x	x
	Willow Park		x			x	x	x	x

Using the cost information in Appendix B, preliminary opinions of probable cost were generated for capital expenditures and annual expenditures. These costs represent the entire cost of treating all wastewater in the Planning Area. Two preliminary opinions of annual cost were generated:

- $AC_1$ , which includes payment of debt service on the necessary improvements. It was assumed that the capital costs were financed for a term of 20 years, so this annual cost would be effective for the first 20 years of the life of the facilities.
- $AC_2$ , which assumes the debt has been paid. This annual cost would be effective after the first 20 years of facility life.

### **5.2.2 Comparison of System Configurations**

The expected useful life of the new facilities is approximately 50 years.<sup>5</sup> Therefore, a 50-year weighted average of the two preliminary opinions of annual cost was used to compare the costs of multiple system configurations. The weighted average preliminary opinion of annual cost was calculated as  $AC_w = 0.4*AC_1 + 0.6*AC_2$ .

### **5.2.3 Identification of the Lowest-Cost 2030 Configuration**

In theory, one could enumerate all possible configurations of the regional collection system, generate weighted average preliminary opinions of annual cost for each configuration, and select the configuration with the lowest opinion of cost. Practically, however, this is not possible, due to computing time and data storage requirements.<sup>32</sup> Therefore, a genetic algorithm was used to analyze the possible configurations and select the target configuration.

Using principles of evolutionary biology such as selection, inheritance, and mutation, a genetic algorithm takes a population of solutions to a problem and uses them to “breed” new solutions that contain the best characteristics of the “parent” solutions. To begin the analysis, 100 possible regional collection system configurations were generated,<sup>33</sup> and weighted average preliminary opinions of annual cost were calculated. The genetic algorithm was used to combine portions of the original solutions, with extra weighting given to low-cost solutions, into a new

---

<sup>32</sup> Mathematically, there are more than 32 quadrillion possible system configurations.

<sup>33</sup> By assigning random wastewater treatment locations to each primary wastewater collection point (according to the options shown in Table 5-1) and by randomly determining whether an existing WWTP was allowed to expand or not.

generation of 100 regional collection system configurations. This process was repeated through more than 400 generations<sup>34</sup> and the population of configurations was allowed to evolve until a lower-cost configuration could not be identified.

In addition, a small percentage of the new configurations in each generation were allowed to “mutate” during the evolution process. In other words, for some configurations, characteristics such as the wastewater treatment location for a given primary wastewater collection point or whether an existing WWTP is allowed to expand were randomly changed. The mutation process allows the genetic algorithm to constantly seek new configurations so that it searches the entire universe of potential configurations.

In this way, the genetic algorithm considered all possible combinations of the following options for wastewater treatment in the Planning Area:

- One, two, three, or four potential regional WWTPs;
- Discontinued use of one, two, three, or four of the existing WWTPs;
- Continued use of one, two, three, or four of the existing WWTPs at their currently permitted flowrates; and
- Expansion of one, two, three, or four of the existing WWTPs.

Figure 5-4 shows the lowest-cost 2030 configuration identified with the genetic algorithm. This configuration includes retirement of the Aledo, Deer Creek Waterworks, and Willow Park WWTPs.

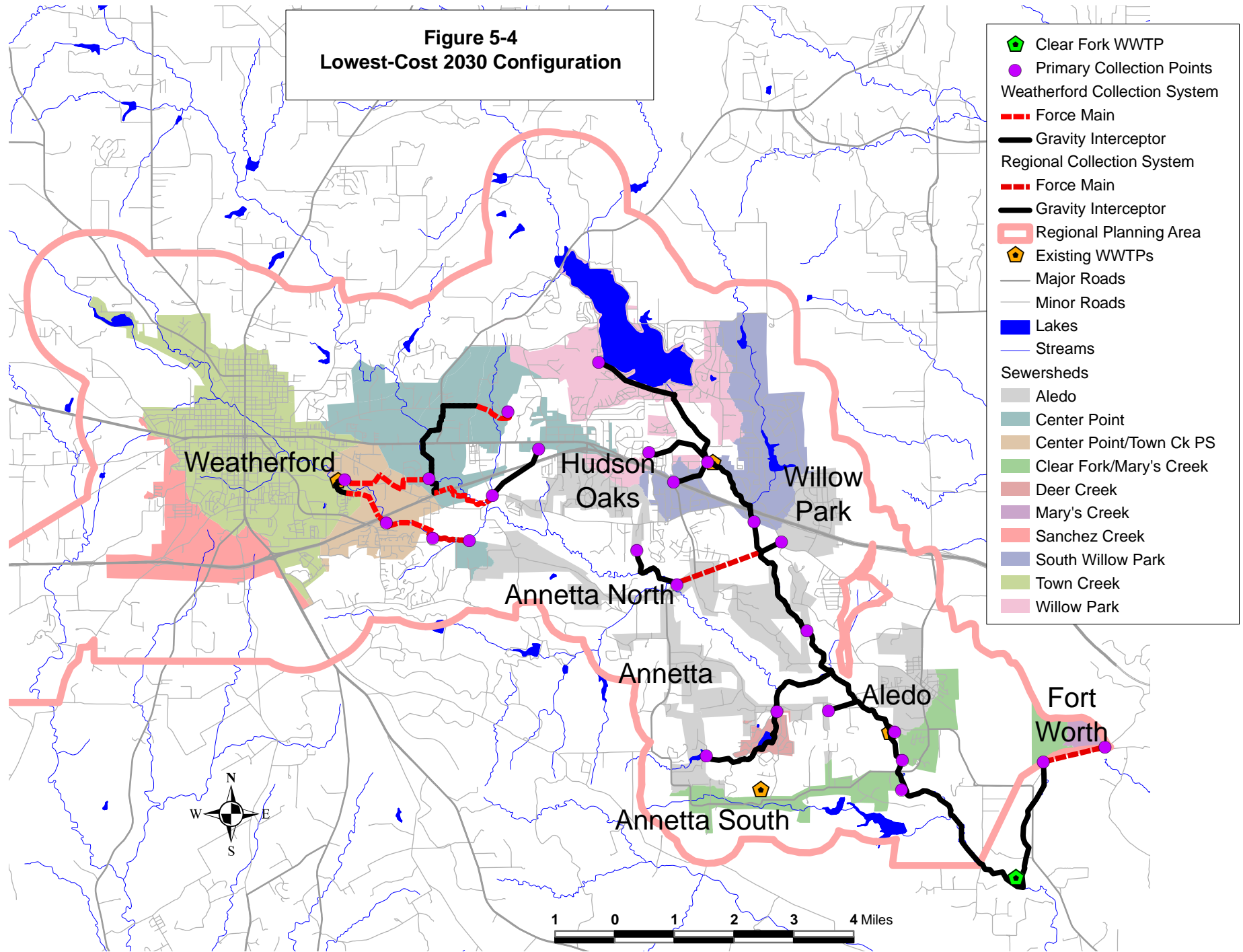
#### 5.2.4 **Alternative Configurations**

As discussed above, many other regional wastewater system configurations are possible. The following alternatives are discussed below: keeping existing WWTPs in service and an alternative that includes both a South Willow Park WWTP and a Clear Fork WWTP.

---

<sup>34</sup> The lowest-cost configuration was identified in the 109<sup>th</sup> generation.

**Figure 5-4  
Lowest-Cost 2030 Configuration**



- Clear Fork WWTP
- Primary Collection Points
- Weatherford Collection System**
- Force Main
- Gravity Interceptor
- Regional Collection System**
- Force Main
- Gravity Interceptor
- Regional Planning Area
- Existing WWTPs
- Major Roads
- Minor Roads
- Lakes
- Streams
- Sewersheds**
- Aledo
- Center Point
- Center Point/Town Ck PS
- Clear Fork/Mary's Creek
- Deer Creek
- Mary's Creek
- Sanchez Creek
- South Willow Park
- Town Creek
- Willow Park

### 5.2.4.1 Keeping Existing WWTPs in Service

For each existing WWTP that is not included in the lowest-cost 2030 configuration, the cost impact of keeping each WWTP in service was projected. In each case, the only change to the lowest-cost 2030 configuration shown in Figure 5-4 was keeping one existing WWTP in service and allowing it to expand just enough to serve projected flows, if necessary.

Table 5-2 shows the results of this analysis. For example, continuing to operate the Aledo WWTP and expanding just enough to meet projected flows is projected to cost Aledo about 1 percent more than participating in the lowest-cost 2030 regional wastewater system and is projected to increase the cost to the remaining regional system participants by about 13 percent. However, the projected cost for Aledo does not include rehabilitation of existing facilities at the Aledo WWTP, and there is no room for expansion at the existing WWTP, so additional land or a second WWTP would be required. Therefore, from a 2030 perspective, it appears to be beneficial to Aledo to take its existing WWTP out of service and participate in the regional wastewater system.

**Table 5-2  
Projected 2030 Cost Changes if Individual WWTPs Remain in Service**

<b>Existing WWTP</b>	<b>Projected Treatment Cost at Existing WWTP Compared to Projected Cost of Regional System</b>	<b>Projected Increased Cost to Regional System Participants</b>
Aledo WWTP	+1%	+13%
Willow Park WWTP	+16%	+12%
Deer Creek Waterworks WWTP	+39%	+1%

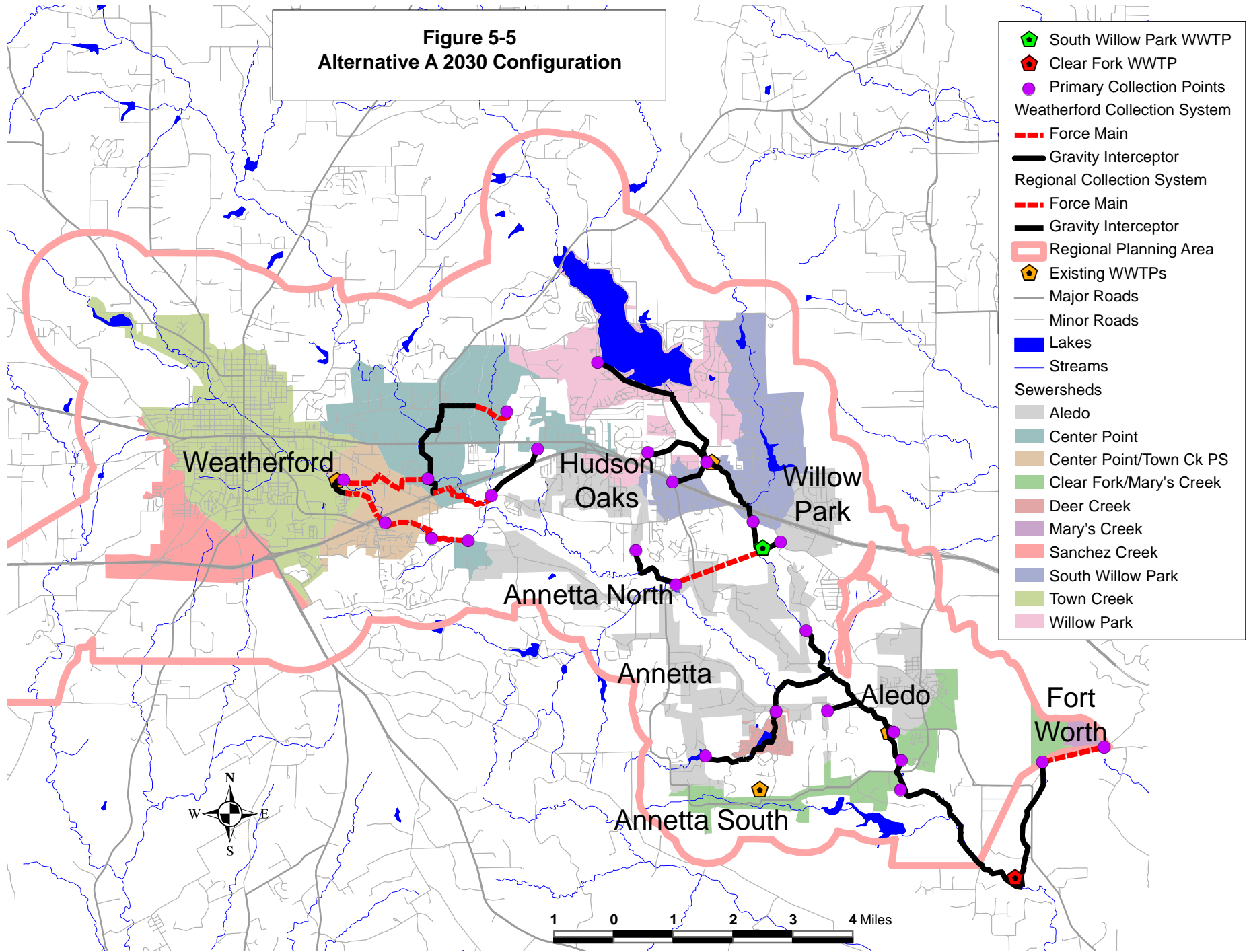
Based on the projected costs to Willow Park for keeping the Willow Park WWTP or the Deer Creek Waterworks WWTP in service, it appears to be beneficial to Willow Park to take these existing WWTPs out of service and participate in the regional wastewater system.

### 5.2.4.2 Alternative A 2030 Configuration

As discussed in Section 5.3.1, the lowest-cost 2030 configuration would be implemented in phases, and it could take up to 15 years before regional wastewater service became available to Willow Park and portions of Hudson Oaks and Annetta North. With the addition of a second regional WWTP at the South Willow Park site (Figure 4-1), regional wastewater service to these cities could be provided sooner. The Alternative A 2030 configuration is shown in Figure 5-5.



**Figure 5-5**  
**Alternative A 2030 Configuration**



- ◆ South Willow Park WWTP
- ◆ Clear Fork WWTP
- Primary Collection Points
- Weatherford Collection System
- - - Force Main
- Gravity Interceptor
- Regional Collection System
- - - Force Main
- Gravity Interceptor
- Regional Planning Area
- ◆ Existing WWTPs
- Major Roads
- Minor Roads
- Lakes
- Streams
- Sewersheds
- Aledo
- Center Point
- Center Point/Town Ck PS
- Clear Fork/Mary's Creek
- Deer Creek
- Mary's Creek
- Sanchez Creek
- South Willow Park
- Town Creek
- Willow Park

The advantages of the Alternative A 2030 configuration include:

- Regional wastewater service would become available to Willow Park and portions of Hudson Oaks and Annetta North at an earlier date.
- Earlier regional wastewater service would reduce new septic system installations, potentially protecting water quality.
- Earlier regional wastewater service could reduce the need for expanded treatment capacity at the Willow Park WWTP.

The disadvantages of the Alternative A 2030 configuration include:

- The weighted average preliminary opinion of annual cost is 3 to 4 percent greater than for the lowest-cost 2030 configuration.
- The South Willow Park WWTP would discharge treated effluent to a section of the Clear Fork Trinity River that is listed on the 303(d) list<sup>t</sup> of water bodies that do not meet the Texas Surface Water Quality Standards<sup>u</sup> due to depressed dissolved oxygen (see Section 6.1.1 for a complete discussion of the 303(d) list and its implications). Therefore, permitting a discharge in this location would be difficult or impossible to accomplish.
- Construction of a regional WWTP at the South Willow Park site could face significant public opposition, which could delay implementation and partially or completely negate the benefits of earlier regional wastewater service. A previous proposal to locate a WWTP in the South Willow Park area faced significant public opposition and resulted in legal action.

Due to the potential for permitting difficulties and public opposition, this alternative does not appear feasible at this time. However, the advantages of this alternative are substantial. Therefore, if water quality conditions and public perceptions change in the future, the regional wastewater service provider should reevaluate the potential for implementing this alternative configuration.

### **5.2.5 Target 2030 Configuration**

After consideration of alternative configurations, the lowest-cost 2030 configuration identified with the genetic algorithm was selected as the target 2030 regional wastewater system configuration. This configuration best balances the cost of transporting wastewater over long distances with the cost of constructing, operating, and maintaining multiple small WWTPs.

Based solely on analysis of 2030 conditions, with no consideration of how improvements might be implemented or whether additional capacity is needed beyond 2030 (these topics are discussed in a later section), the target 2030 configuration is as follows (Figure 5-4):

- With the exception of the Lake Weatherford area (Lift Station 14), all flow from Weatherford is transported to the Weatherford WWTP for treatment.
- Flows from the Center Point sewersheds in Hudson Oaks and Annetta North are transported to the Weatherford WWTP for treatment.
- Flows from the Lake Weatherford area (Lift Station 14), from the remaining sewersheds in Hudson Oaks and Annetta North, and from Willow Park, Annetta, Annetta South, and Fort Worth are transported to the Clear Fork WWTP for treatment.
- The Aledo, Willow Park, and Deer Creek Waterworks WWTPs are no longer in service.

### 5.2.6 **Sensitivity Analysis**

The target 2030 configuration was identified based on 100 percent of the projected wastewater flows being connected to the regional collection system. However, in some of the participating cities (principally Annetta, Annetta North, Annetta South, and to a somewhat lesser extent, Hudson Oaks and Willow Park), existing residences and businesses use septic systems for wastewater treatment. Many of these residences and business may continue to do so in the foreseeable future.

To assess the sensitivity of the target 2030 system configuration, the flows from Annetta, Annetta North, Annetta South, Hudson Oaks, and Willow Park were reduced to 50 percent of the projected wastewater flow for each city, and the genetic algorithm analysis of the regional system was repeated. Although some of the facility sizes were changed, the target 2030 configuration described in Section 5.2.5 was unchanged.

## **5.3 IMPLEMENTATION OF A REGIONAL COLLECTION SYSTEM**

The analysis of potential regional collection system configurations discussed in previous sections was designed to identify a target low-cost configuration based on 2030 conditions, without consideration of whether improvements would be phased or whether additional capacity beyond 2030 needs should be provided. This section discusses the transition from existing wastewater treatment in the Planning Area toward the target configuration, resulting in an implementation plan for the regional collection system.

### 5.3.1 **Summary**

It is not feasible to construct the entire regional collection system immediately. Annetta, Annetta North, Annetta South, and the portion of Fort Worth in the Planning Area do not have local

wastewater collection systems. In addition, Hudson Oaks and Willow Park have collection systems that serve only a small part of each city. Time is needed to develop these local collection systems. Therefore, the regional collection system should be implemented in phases (Figure 5-6) according to projected needs. It is anticipated that Phase 1 would be implemented by 2012, Phase 2 by 2016, and Phase 3 by 2021.

Weatherford would begin to contribute flow from the Lake Weatherford area (Lift Station 14) to the regional system in Phase 3. Until Phase 3 is implemented, Weatherford should make any improvements necessary to continue to convey flow from Lift Station 14 to the Weatherford WWTP. Upon completion of Phase 3, it has been assumed that Weatherford will continue to convey part of its flow to the Weatherford WWTP and that excess flow will go to the Clear Fork WWTP.

Implementation details (facilities, sizes, phases, opinions of cost, etc.) for the regional collection system are presented in Appendix C. Opinions of probable cost are discussed in Chapter 9. A more detailed implementation plan and schedule are presented in Chapter 10.

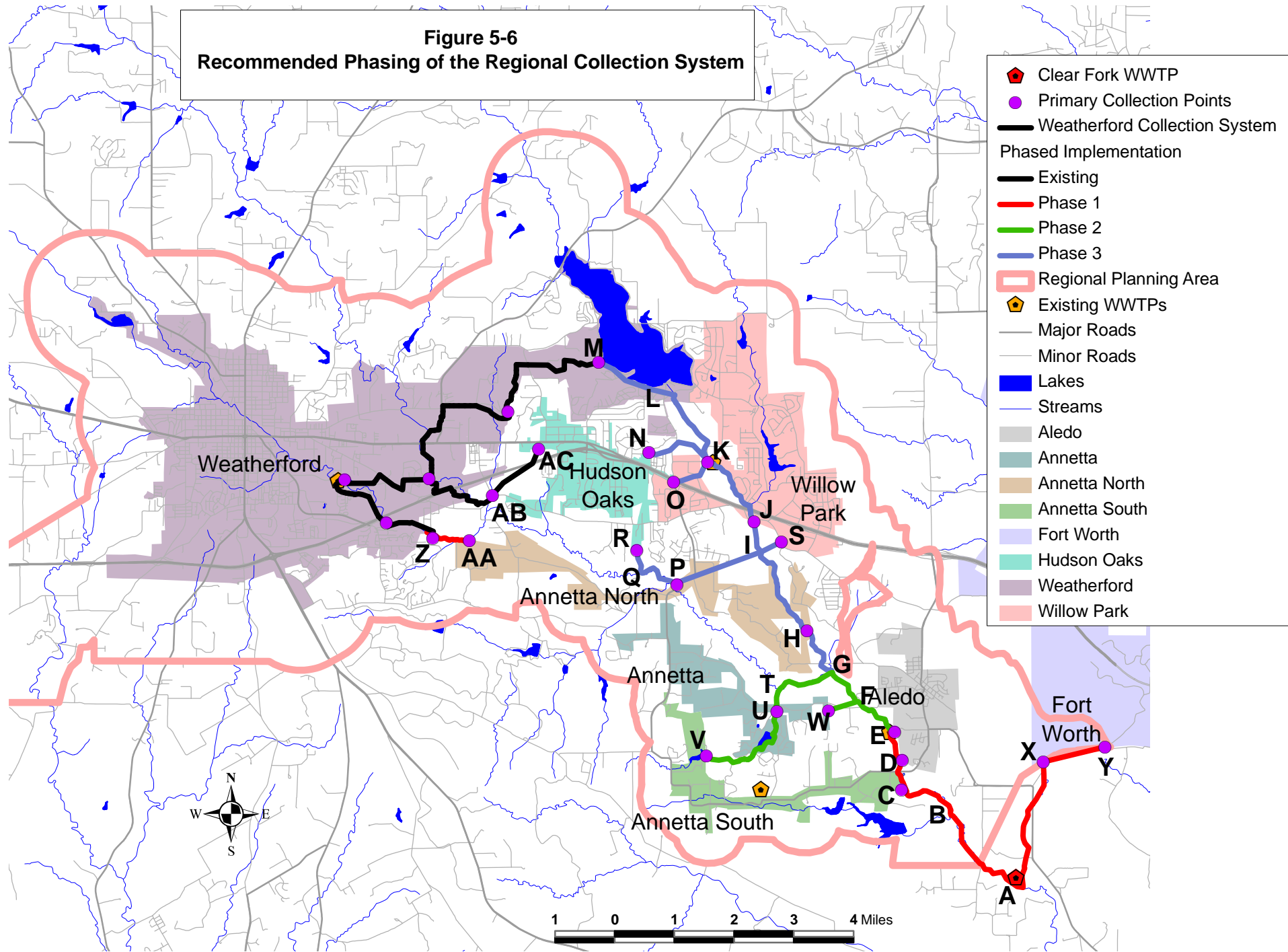
### **5.3.2 Potential for Interaction with Proposed Mary's Creek WRC**

As discussed in Chapter 2, Fort Worth conducted preliminary planning for a possible water recycling center (WRC) in the Mary's Creek watershed, which is adjacent to the Clear Fork Trinity River watershed (Figure 2-8). Possible interactions between the regional wastewater system and the Mary's Creek WRC include pumping of wastewater or reclaimed water between basins. Each potential combination is discussed below.

#### **5.3.2.1 Pump Wastewater or Reclaimed Water from Mary's Creek Basin to Clear Fork Basin**

Wastewater could be pumped from the Mary's Creek Basin to the Clear Fork WWTP for treatment. In this case, the two proposed wastewater treatment plants could be consolidated into one regional plant and additional reclaimed water could be captured in Benbrook Lake for indirect potable reuse. A preliminary analysis of the potential costs, using projected flows generated in the 2004 Fort Worth planning and the cost guidelines in Appendix B, indicates that the cost of the pipeline and pump station necessary to convey the wastewater from the Mary's Creek WRC to the Clear Fork WWTP would exceed the cost savings from consolidating the treatment plants. In addition, to provide reclaimed water for direct nonpotable reuse in the

**Figure 5-6  
Recommended Phasing of the Regional Collection System**



Mary's Creek Basin, some or all of the additional reclaimed water would have to be pumped back to the Mary's Creek Basin. Therefore, this does not appear to be a feasible option.

Reclaimed water could be pumped from the Mary's Creek WRC to the Clear Fork Basin for discharge and capture in Benbrook Lake. Fort Worth previously considered this alternative and found that it would only be cost-effective if the TRWD compensated the city for the reclaimed water captured in Benbrook Lake. The TRWD was unwilling to do so, preferring to capture this reclaimed water further downstream as part of its Richland-Chambers and Cedar Creek reuse projects.

#### **5.3.2.2 Pump Wastewater or Reclaimed Water from Clear Fork Basin to Mary's Creek Basin**

Wastewater could be pumped from the Clear Fork WWTP to the Mary's Creek WRC for treatment. In this case, the two wastewater treatment plants could be consolidated into one regional plant. This could also be advantageous if water quality conditions limited the amount of wastewater that could be discharged to the Clear Fork Trinity River. A preliminary analysis of the potential costs, using projected flows generated in the 2004 Fort Worth planning and the cost guidelines in Appendix B, indicates that the cost of the pipeline and pump station necessary to convey the wastewater from the Clear Fork WWTP to the Mary's Creek WRC would exceed the cost savings from consolidating the treatment plants. In addition, as discussed in Chapter 6, no water quality conditions have been identified that would limit the discharge of reclaimed water from the Clear Fork WWTP during the planning period. Therefore, this does not appear to be a feasible option.

Reclaimed water could be pumped from the Clear Fork WWTP to the Mary's Creek Basin for discharge, allowing the sale of reclaimed water to customers in the Mary's Creek Basin for direct nonpotable reuse or to Fort Worth for indirect potable reuse. A preliminary analysis of the potential costs, using the cost guidelines in Appendix B, indicates that such a project may be feasible, depending on customer demands and the price of the reclaimed water. A qualitative discussion of potential reuse projects is presented in Chapter 8.

#### **5.3.2.3 Summary**

In summary, it does not appear feasible to convey untreated wastewater between the Clear Fork WWTP and Mary's Creek WRC, nor does it appear feasible to convey reclaimed water

from the Mary's Creek WRC for discharge to the Clear Fork Trinity River upstream of Benbrook Lake. It may be feasible, depending on the project details, to supply reclaimed water from the Clear Fork WWTP to the Mary's Creek Basin for reuse.

## CHAPTER 6

### PROJECTED EFFLUENT WATER QUALITY REQUIREMENTS

The selection of treatment processes, as detailed in Chapter 7, depends on quality requirements for the treated effluent. The projected effluent water quality requirements depend on currently identified water quality issues and model projections of future water quality. These issues and projections are discussed below

#### 6.1 WATER QUALITY ISSUES

For regulatory purposes, the TCEQ has designated Clear Fork Trinity River Below Lake Weatherford (and above Lake Benbrook) as Segment 0831. With the exception of the Deer Creek Waterworks WWTP, which has a zero discharge permit and pumps its treated effluent to the Split Rail Links and Golf Club, existing municipal wastewater dischargers in the regional planning area discharge treated effluent to Segment 0831 or its tributaries (Figure 6-1). The proposed Clear Fork WWTP would also discharge to Segment 0831. Water from Segment 0831 flows into Benbrook Lake (Segment 0830) approximately 7 miles downstream of the planning area. Water quality issues for these segments are discussed in the following sections.

##### 6.1.1 303(d) List

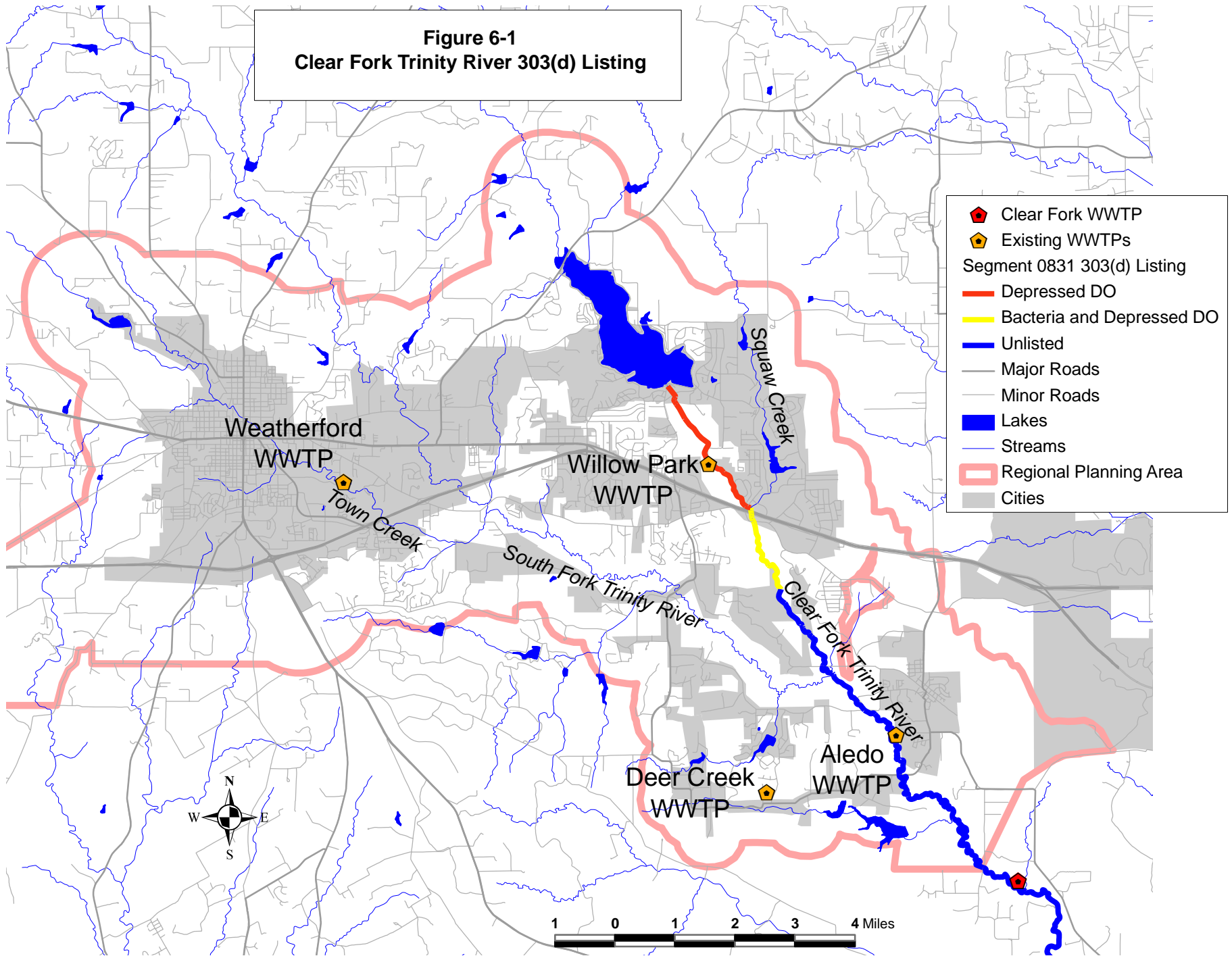
All surface water bodies in Texas are required to meet the Texas Surface Water Quality Standards (TSWQS).<sup>u</sup> As required by Section 303(d) of the Clean Water Act, the TCEQ maintains a list<sup>t</sup> of water bodies that do not meet the TSWQS. When a segment is included on the 303(d) list, the TCEQ requires one of three actions:

- Initiate a Total Daily Maximum Load (TMDL) analysis to identify the problem and develop a plan to bring the segment into compliance,
- Review the water quality standards for this water body, or
- Collect additional data and information.

According to the 303(d) list, Segment 0831 does not support aquatic life use between the Lake Weatherford Dam and the Squaw Creek confluence due to depressed dissolved oxygen (Figure 6-1). In addition, Segment 0831 is “partially supporting” of aquatic life use (depressed dissolved oxygen) and does not support contact recreation use (bacteria) between the Squaw Creek confluence and a point 2 miles upstream of the South Fork Trinity River confluence. As a result, the dissolved oxygen standard for the Clear Fork Trinity River is under review and additional



**Figure 6-1**  
**Clear Fork Trinity River 303(d) Listing**



bacteria data are being collected. Depending on the outcome of these actions, it is possible that a TMDL could be initiated that would limit the discharge of oxygen-demanding substances to Segment 0831.

As configured in Chapter 5, the proposed regional wastewater system would not impact the portion of the Clear Fork Trinity River that does not meet the TSWQS. Therefore, it is not anticipated that the permit for the proposed regional wastewater system would be affected by upstream water quality issues. In addition, the TCEQ is reviewing the standard for minimum dissolved oxygen in the South Fork Trinity River. The current minimum concentration is 5 milligrams per liter (mg/l), but long-term biological collections appear to support a minimum concentration of 4 mg/l.<sup>v</sup> The outcome of this review will affect the effluent water quality requirements for the Weatherford WWTP. For this Plan, it has been assumed that the minimum dissolved oxygen standard will be changed to 4 mg/l. The Weatherford WWTP already produces effluent that is consistent with the more stringent 5 mg/l standard, so no changes in plant facilities or operation are expected to result from a 4 mg/l standard.

#### **6.1.2 Other Published Concerns**

The TCEQ has also published water quality concerns that do not have a regulatory impact.<sup>w</sup> Between a point two miles upstream of the South Fork Trinity River confluence and the South Fork Trinity River confluence, Segment 0831 is of “concern” for aquatic life use (depressed dissolved oxygen). Between the South Fork Trinity River confluence and Lake Benbrook, the segment is of “concern” for aquatic life use (depressed dissolved oxygen), contact recreation use (bacteria), and nutrient enrichment (orthophosphorus).

The bacteria findings for Segment 0831 result from the fact that water samples collected from the Clear Fork Trinity River since 1996 have had elevated levels of fecal coliforms. Elevated fecal coliform counts are consistent with nonpoint source pollution, some of which could originate from malfunctioning septic systems.

The Clear Fork Trinity River Below Lake Weatherford (Segment 0831) flows into Benbrook Lake (Segment 0830) approximately 7 miles downstream of the planning area. Segment 0830 is fully supporting of all designated water body uses, but it is classified as water quality limited, and there is “concern” for nutrient enrichment in the lower portion of the reservoir and for algal growth in the entire reservoir.<sup>w</sup>

### **6.1.3 Reclaimed Water Quantity Issues**

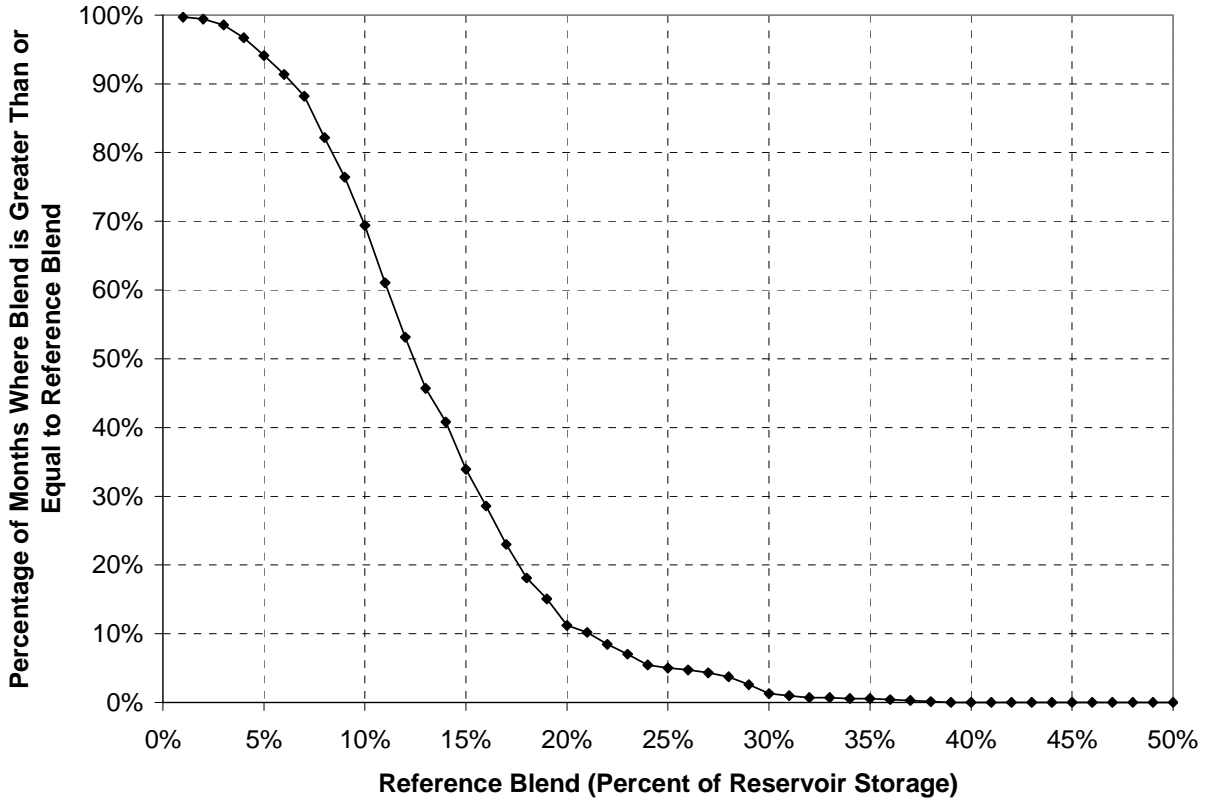
Treated effluent (or reclaimed water) discharged to the Clear Fork Trinity River flows to Benbrook Lake, which is a water supply source for the TRWD and its customers. In addition to meeting the requirements of the TSWQS and addressing concerns such as nutrient enrichment, public health and safety must also be protected. As further discussed below, one way to protect public health and safety is to limit the volume of reclaimed water that flows to Benbrook Lake.

The water supply industry continues to gain more knowledge about constituents present in water due to improved analytical testing techniques. Water quality issues that were not previously a concern (e.g., cryptosporidium) continue to emerge. In many cases, the consequences of newly identified constituents are not well known, particularly with respect to public health, and available science and technology cannot fully address these uncertainties. To protect public health, a multiple-barrier approach is recommended to manage the uncertainties associated with the indirect potable use of reclaimed water. The multiple barriers include advanced wastewater treatment, limits on the blend of reclaimed and natural water, requirements on the residence time in the lake, and advanced water treatment. Each of these barriers is interdependent with the others, and the extent to which each of these barriers should be applied is also interdependent. For example, there should be a greater degree of treatment for situations that involve larger blends of reclaimed water and shorter detention times.

In 2001, the TRWD developed a water balance model of Benbrook Lake to represent inflows, outflows, and storage of water based on projected 2020 development conditions. This water balance was used without modification to give an initial indication of the potential reclaimed water blend in Benbrook Lake. In 2020, it is projected that approximately 7 mgd of reclaimed water will be discharged from WWTPs in the Planning Area and will flow to Benbrook Lake.

Figure 6-2 shows the potential reclaimed water blend in Benbrook Lake for 2020 conditions. The initial estimate is that reclaimed water would make up 12.4 percent or more of the water stored in the reservoir about 50 percent of the time. Figure 6-3 shows the projected reclaimed water residence time in Benbrook Lake under 2020 conditions. The initial estimate is a 50 percent chance that the reclaimed water residence time would be three years or more.

**Figure 6-2  
Potential 2020 Reclaimed Water Blend Frequency for Benbrook Lake**

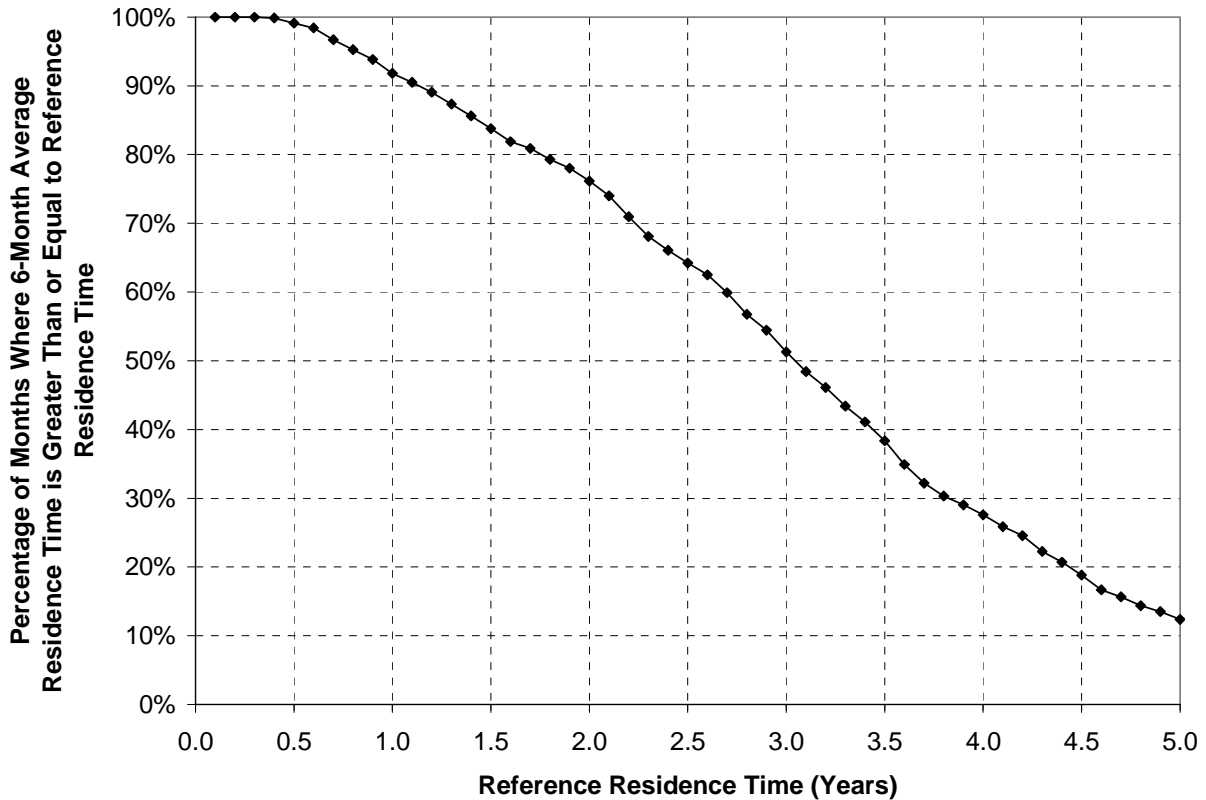


Note that the projected 2020 population, water demand, and reservoir operations in the water balance model have not been updated since 2001 and should be updated to refine the initial estimates in Figure 6-2 and Figure 6-3.

**6.2 MODELING PROJECTIONS**

The impact of effluent water quality on dissolved oxygen in the Clear Fork Trinity River and on algal growth in Benbrook Lake was analyzed with a stream water quality model (QUAL-TX) and a reservoir water quality model (WASP). The following sections describe this analysis and the selection of projected effluent water quality requirements.

**Figure 6-3  
Potential 2020 Reclaimed Water Residence Time Frequency for Benbrook Lake**



**6.2.1 Dissolved Oxygen**

Treated effluent contains oxygen-demanding substances that cause a decrease in dissolved oxygen in the receiving stream until such substances are oxidized. The TCEQ has constructed QUAL-TX stream models to analyze the impacts on dissolved oxygen from discharges of treated effluent to the South Fork Trinity River and the Clear Fork Trinity River. Using these models, the impacts of different concentrations of carbonaceous biochemical oxygen demand (CBOD), ammonia, and dissolved oxygen in the treated effluent from the Weatherford, Aledo, and Clear Fork WWTPs were analyzed.

Two effluent discharge scenarios were analyzed. Under Scenario A, flow would be discharged from the Weatherford, Aledo, and Clear Fork WWTPs. Under Scenario B, flow would be discharged from the Weatherford and Clear Fork WWTPs. The 2030 annual average flowrates for each scenario are shown in Table 6-1.

**Table 6-1  
2030 Annual Average Flowrates for QUAL-TX Analysis (mgd)**

<b>Scenario</b>	<b>Weatherford WWTP</b>	<b>Aledo WWTP</b>	<b>Clear Fork WWTP</b>
A	4.67	0.60	4.16
B	4.67	0.00	4.76

The projected effluent water quality requirements are the same for both scenarios (Table 6-2). Based on these effluent concentrations, the projected dissolved oxygen concentrations under summer low-flow conditions in the South Fork Trinity River and the Clear Fork Trinity River for both scenarios are shown in Figure 6-4. Typically, the TCEQ allows scenarios where the minimum dissolved oxygen is no more than 0.2 milligrams per liter (mg/l) less than the dissolved oxygen standard.

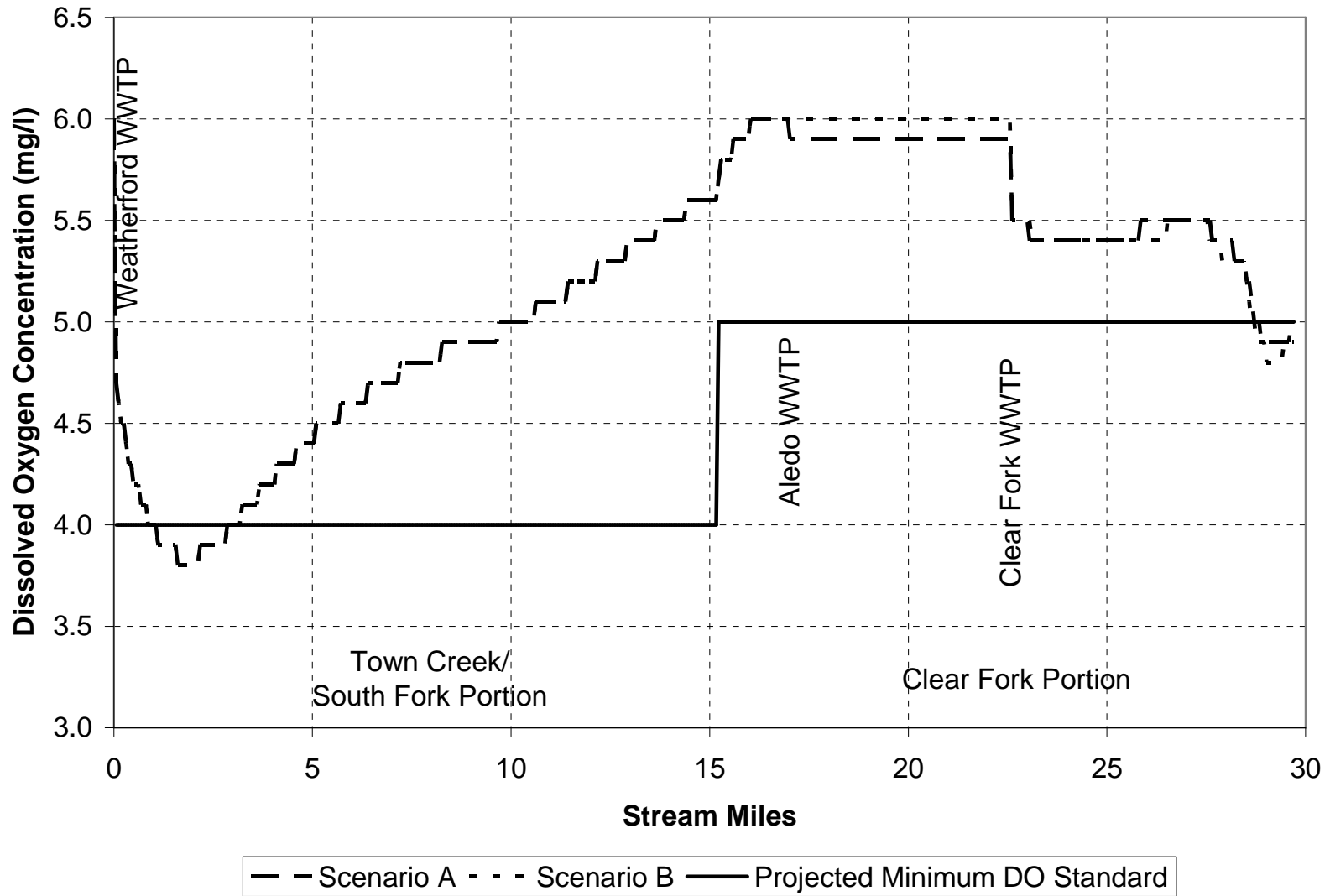
**Table 6-2  
2030 Projected Treated Effluent Water Quality Requirements (mg/l)**

<b>Item</b>	<b>Weatherford WWTP</b>	<b>Aledo WWTP</b>	<b>Clear Fork WWTP</b>	<b>Concern</b>
Maximum CBOD	10	10	10	Dissolved Oxygen
Maximum Ammonia	2	2	2	Dissolved Oxygen
Minimum Dissolved Oxygen	5	5	5	Dissolved Oxygen
Maximum Total Phosphorus	1	1	1	Algal Growth

As shown in Figure 6-4, the dissolved oxygen “sag” caused by treated effluent discharged from the Weatherford WWTP completely disappears before reaching the Aledo WWTP. Therefore, the effluent water quality requirements for the Weatherford WWTP are independent of the requirements at the downstream WWTPs. However, effluent water quality requirements at the Aledo WWTP and the Clear Fork WWTP are interdependent.

It is important to note that the water discharged from the Weatherford WWTP provides dilution water for the downstream plants. Weatherford is currently developing a reclaimed water plan. If Weatherford reuses all of its reclaimed water and does not discharge any water from the WWTP, it is projected that the effluent water quality requirements at the Clear Fork WWTP

**Figure 6-4**  
**Projected Dissolved Oxygen Concentrations, Summer Low-Flow Conditions**



would be 5 mg/l maximum CBOD, 1.8 mg/l maximum ammonia, 5 mg/l minimum dissolved oxygen, and 1 mg/l maximum total phosphorus.

### 6.2.2 **Nutrients**

Nitrogen and phosphorus in treated effluent provide nutrients that are necessary for algal growth. One way to limit algal growth in receiving waters is to restrict the nutrients in the treated effluent. Using the Water Quality Assessment Simulation Program (WASP), a reservoir water quality model, TRWD staff performed a preliminary projection of the impact of nutrient limits on algal growth in Benbrook Lake.

The Benbrook Lake WASP model was calibrated based on 1992-93 hydrologic conditions. During this time, approximately 1.90 mgd of treated effluent was being discharged to the Clear Fork Trinity River from the Weatherford and Aledo WWTPs. By 2030, it is projected that up to 9.43 mgd of treated effluent will be discharged to the Clear Fork (Table 3-4). Therefore, an additional 7.53 mgd of reclaimed water (the difference between the projected 2030 discharge and the actual 1992-93 discharge) was added to the Benbrook Lake WASP model.

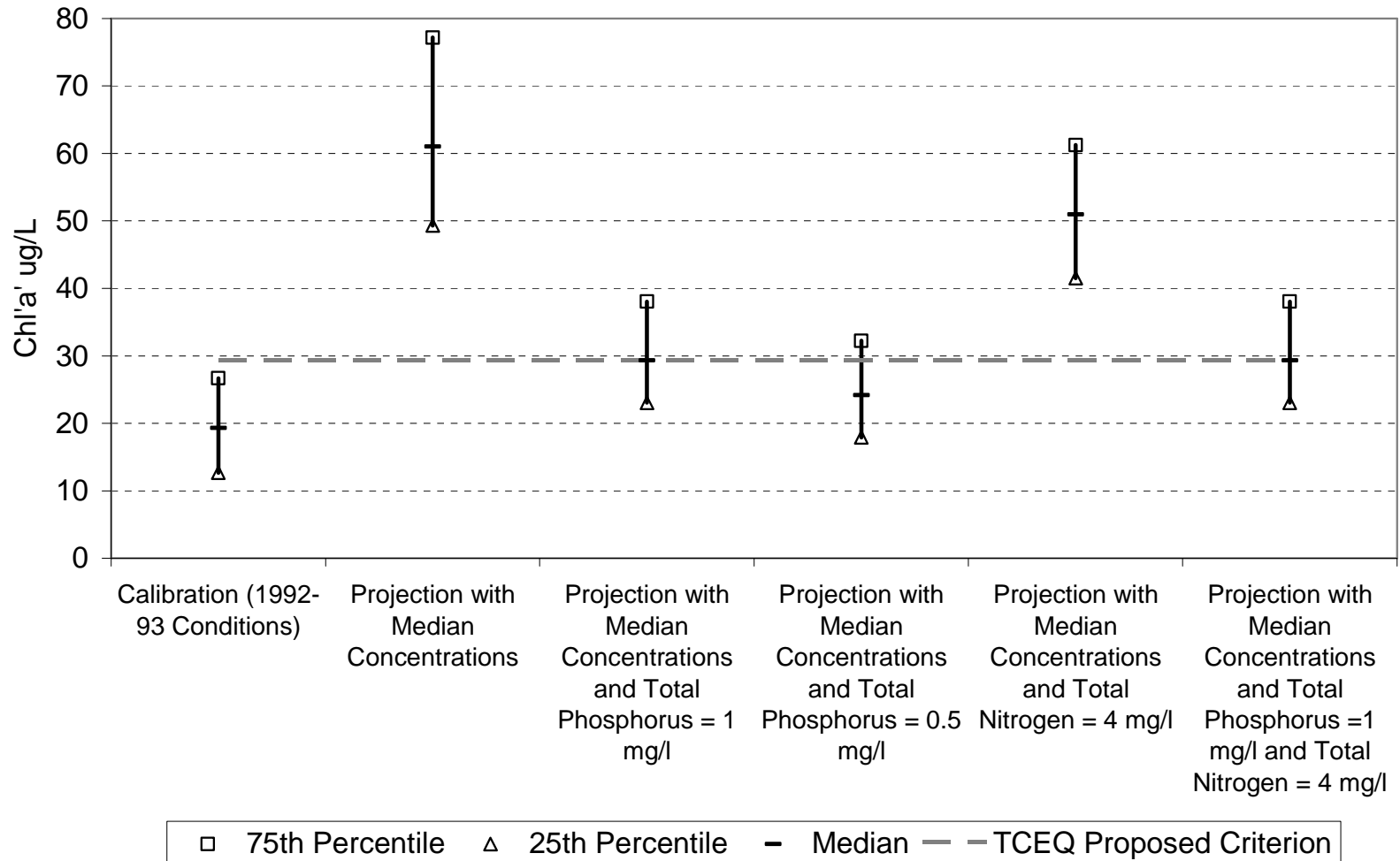
Intensive sampling of reclaimed water at the Weatherford WWTP was performed in 2002. The nutrient concentrations associated with the additional 7.53 mgd of reclaimed water are the medians of the concentrations measured at the Weatherford WWTP during 2002.

Using the above reclaimed water flow and quality, the Benbrook Lake WASP model was used to project chlorophyll-a concentrations at the surface near the dam for different sets of nutrient requirements (Figure 6-5). The TCEQ has proposed a chlorophyll-a criterion of 29.37 micrograms per liter ( $\mu\text{g/l}$ ) for Benbrook Lake.<sup>x</sup> Adding an additional 7.53 mgd of reclaimed water at the median nutrient concentrations discussed above is projected to cause the median chlorophyll-a concentrations to increase from about 19  $\mu\text{g/l}$  to about 61  $\mu\text{g/l}$ . If the total phosphorus in the reclaimed water is limited to 1 mg/l, then the median chlorophyll-a concentration is projected to be about 29  $\mu\text{g/l}$ , or just less than the TCEQ's proposed criterion. Further limiting the total phosphorus in the reclaimed water to 0.5 mg/l results in a projected chlorophyll-a concentration of about 24  $\mu\text{g/l}$ . It is also projected that limiting phosphorus will be more effective than limiting nitrogen in controlling algal growth in Benbrook Lake.



**Figure 6-5**  
**Projected Lake Benbrook Response to Additional Nutrient Loading**

Projected results shown at surface near dam for additional 7.64 mgd of reclaimed water.



Therefore, the 2030 projected effluent water quality requirement for total phosphorus is 1 mg/l (Table 6-2).

Again, the projection of nutrient impacts on algal growth in Benbrook Lake was preliminary in nature. Among other factors, a more advanced analysis would consider future water demands from Benbrook Lake and any resulting changes in reservoir operations.

## CHAPTER 7

### CONCEPTUAL DESIGN FOR REGIONAL WASTEWATER TREATMENT FACILITIES

The selection of recommended treatment processes depends on treated effluent water quality requirements (Table 6-2), as well as cost, flowrates, project phasing, and operational considerations. Recommended treatment units, the conceptual design, and opinions of probable cost are discussed below.

#### 7.1 REQUIRED TREATMENT CAPACITY

With the regional collection system phasing discussed in Chapter 5, the projected annual average flow to the Clear Fork WWTP is shown in Figure 7-1. To provide treatment for the projected flows, the Clear Fork WWTP will be constructed in three phases, as shown in Table 7-1. In accordance with TCEQ design criteria, the Clear Fork WWTP will accommodate a two-hour peak flow of four times the annual average flow.<sup>a</sup>

**Table 7-1  
Clear Fork WWTP Phases and Capacities**

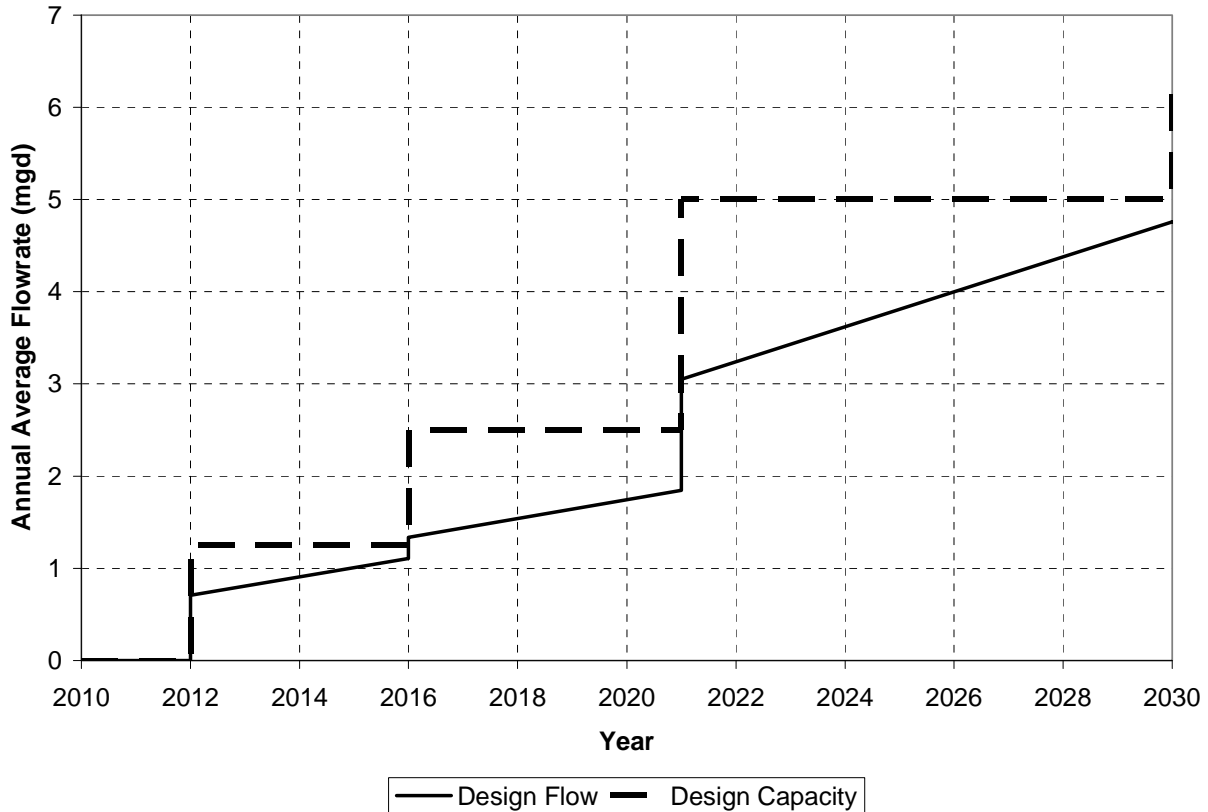
<b>Phase</b>	<b>Additional Annual Average Capacity (mgd)</b>	<b>Total Annual Average Capacity (mgd)</b>	<b>Total Peak Flow Capacity (mgd)</b>
1	1.25	1.25	5.00
2	1.25	2.50	10.00
3	2.50	5.00	20.00

#### 7.2 RAW WASTEWATER QUALITY

From the TCEQ design criteria<sup>y</sup> and APAI's experience with municipal wastewater, the influent untreated wastewater is estimated to have the following concentrations:

- CBOD of 200 mg/l,
- Total suspended solids (TSS) of 200 mg/l,
- Ammonia of 25 mg/l, and
- Total phosphorus of 6 mg/l.

**Figure 7-1  
Clear Fork WWTP Projected Annual Average Flow and Capacity**



### 7.3 RECOMMENDED TREATMENT PROCESSES AND PHASING

Recommended treatment processes for the proposed Clear Fork WWTP are summarized in this section. The treatment units for the Clear Fork WWTP have been sized according to the Design Criteria for Sewerage Systems<sup>2</sup> and according to engineering practice and experience to meet the projected treated water effluent requirements shown in Table 6-2, including nutrient removal.<sup>35</sup> The recommended treatment units were also selected in part to provide a conservative, planning-level opinion of probable cost for wastewater treatment. Alternative treatment units could be considered during preliminary design.

<sup>35</sup> It has been assumed that Weatherford will continue to discharge its reclaimed water to Town Creek. As discussed in Section 6.2.1, if Weatherford reuses a significant portion of its reclaimed water and does not discharge it, the projected treated effluent quality requirements for the Clear Fork WWTP could become more stringent, possibly requiring more aeration basin capacity and more blowers. Since this additional capacity is not easily retrofitted, it is important to coordinate the final Clear Fork WWTP design with Weatherford's reuse plans.

A treatment process schematic is shown in Figure 7-2, and an example site plan is shown in Figure 7-3. The Clear Fork WWTP would be constructed in three phases. The major equipment provided for each phase is outlined in Table 7-2.

Although the example site plan in Figure 7-3 shows a required site of approximately 10.5 acres, which includes the required buffer of 150 feet between any treatment facility and the property line,<sup>aa</sup> it is advisable to acquire a larger site to allow for expansion beyond Phase 3 and/or to allow for a larger buffer area. In addition, the site should be located outside of the 100-year flood plain or protected from a 100-year flood event.<sup>aa</sup> Other restrictions on WWTP sites are contained in Texas Administrative Code Title 30, Chapter 309, Subchapter B.<sup>aa</sup>

### 7.3.1 **Influent Lift Station**

The plant headworks will consist of an influent lift station, fine screens, and vortex grit concentrators. Untreated wastewater will enter the plant from the regional collection system at the influent lift station. The lift station will provide short-term wastewater storage and will convey the wastewater to the fine screens and vortex grit concentrators, shown jointly as the preliminary treatment unit in Figure 7-3.

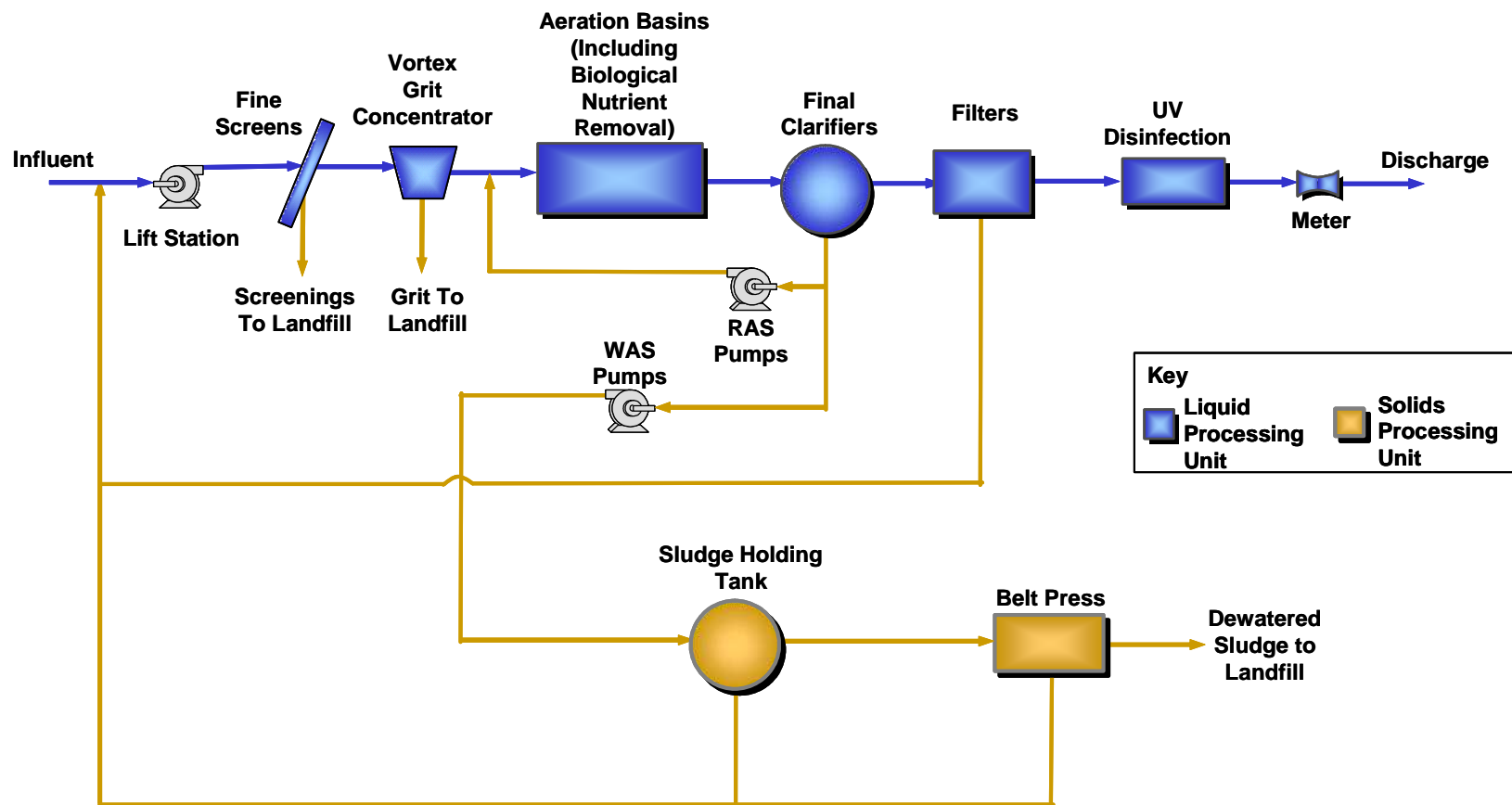
It is anticipated that the influent lift station will be approximately 30 feet deep with 2-foot thick walls, although the actual depth will depend on conditions at the selected site. Two pumps will be replaced by larger units in Phase 2, and a duplicate influent lift station will be constructed in Phase 3.

### 7.3.2 **Fine Screens**

Flow from the influent lift station will be pumped through fine screens to remove rags and other bulk materials that could damage or clog downstream units. Collected screenings will be disposed of at a landfill.

The fine screens will consist of two packaged units in Phase 1. In Phase 2, these packaged units will be replaced by a 20 mgd fine screen with compactor and a bypass channel with a manual bar rack. There will be no expansion of screens in Phase 3.

Figure 7-2  
Clear Fork WWTP Treatment Process Schematic



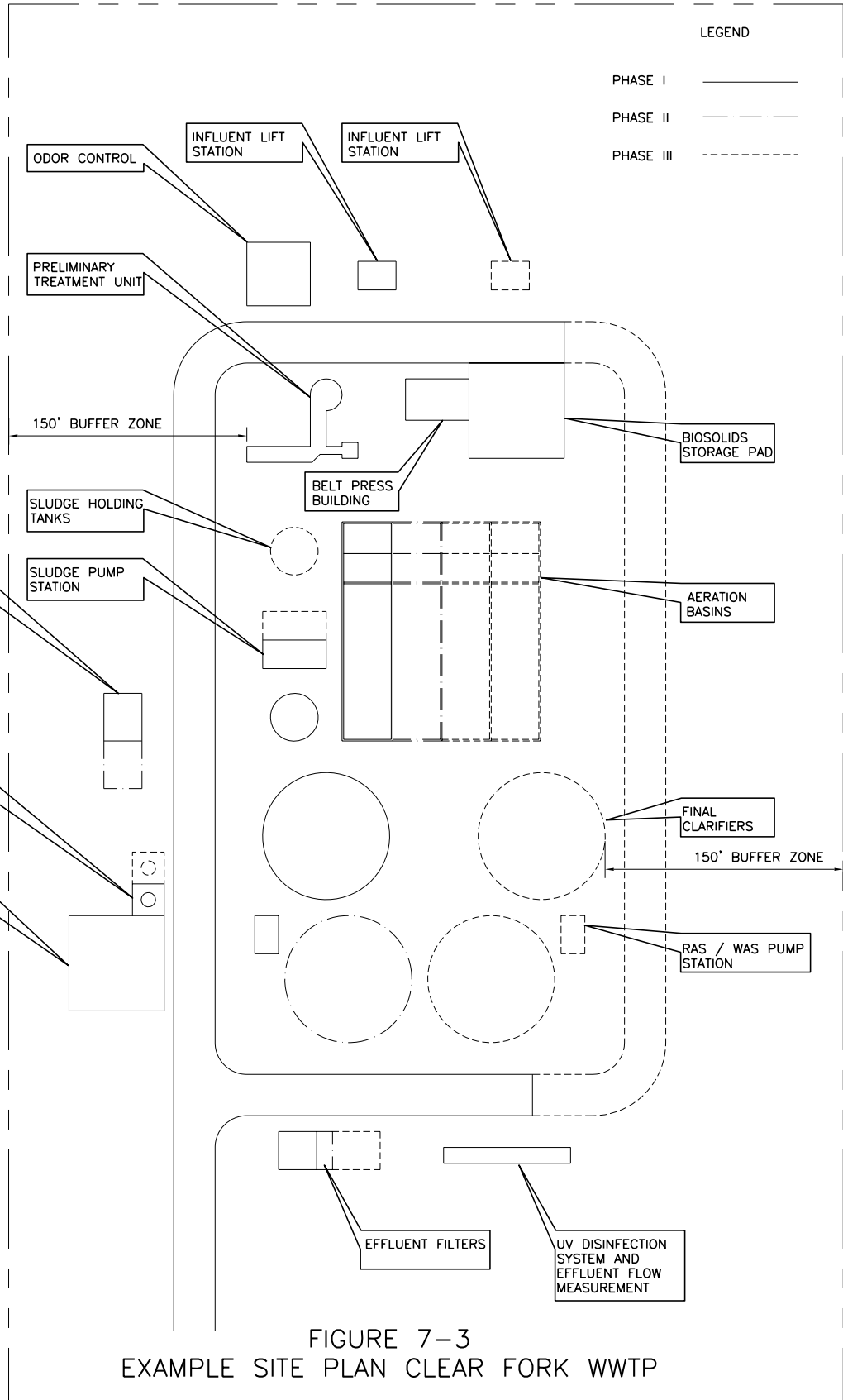


FIGURE 7-3  
 EXAMPLE SITE PLAN CLEAR FORK WWTTP

**Table 7-2  
Clear Fork WWTP Major Equipment by Phase**

<b>Treatment Unit</b>	<b>Item</b>	<b>Phase 1</b>	<b>Phase 2</b>	<b>Phase 3</b>
Influent Lift Station	Number of Units	1	0	1
	Unit Capacity (mgd)	5	10*	10
Fine Screens	Number of Units	2	1**	0
	Unit Capacity (mgd)	2.5	20	NA
Vortex Grit Concentrators	Number of Units	0	1	0
	Unit Capacity (mgd)	0	20	NA
Aeration Basins	Number of Units	1	1	2
	Dimensions (ft)	30 x 128	30 x 128	30 x 128
	SWD (ft)	16	16	16
	Total Volume (gal)	52,000 anaerobic 52,000 anoxic 305,000 aerobic	52,000 anaerobic 52,000 anoxic 305,000 aerobic	52,000 anaerobic 52,000 anoxic 305,000 aerobic
Blowers	Number of Units	3	3	3***
	Unit Size (hp)	100	100	200
Final Clarifiers	Number of Units	1	1	2
	Diameter (ft)	73	73	73
	SWD (ft)	16	16	16
	Total Surface Area (ft <sup>2</sup> )	4,185	4,185	8,371
	Total Volume (gal)	500,000	500,000	1,000,000
Filters	Number of Units	1	0	1
	Filter Media	Cloth Disk	NA	Cloth Disk
	Unit Capacity (mgd)	6	NA****	6
Ultraviolet Disinfection	Number of Channels	2	0	0
	Number of UV Banks	2	2	0
	Channel Capacity (mgd)	5	5	10*****
Sludge Holding Tank	Number of Units	1	0	1
	Diameter (ft)	30	NA	30
	SWD (ft)	16	NA	16
	Total Volume (gal)	84,600	NA	84,600
Belt Presses	Number of Units	1	0	1
	Size (m)	1	NA	2

\* Replace two pumps to increase capacity.

\*\* Replace packaged units from Phase 1.

\*\*\* Replace three blowers to increase capacity.

\*\*\*\* Requires bypassing of a portion of the peak flow beginning in Phase 2.

\*\*\*\*\* Add more modules to the four UV banks.



### **7.3.3 Vortex Grit Concentrators**

The vortex grit concentrators will remove sand, grit, and other heavy, abrasive materials that can cause wear on pumps and other equipment. Flow will proceed from the vortex grit concentrators to aeration basins.

No grit removal will be provided in Phase 1. In Phase 2, a 20 mgd vortex grit concentrator; a grit pump located in a vault; and a hydrogritter, dumpster, and division box will be added. There will be no expansion of grit removal in Phase 3.

### **7.3.4 Aeration Basins**

The aeration basins will contain a well-mixed anaerobic zone, an anoxic zone with air diffusers, and an aerobic zone with air diffusers. Activated sludge will be added to the aeration basin in the anaerobic zone. In the anaerobic zone, microorganisms in the activated sludge will provide biological removal of phosphorus from the wastewater. The anoxic zone will provide a transition to an aerobic zone. In the aerobic zone, biochemical oxygen demand (BOD) and ammonia will be oxidized. Flow will proceed from the aeration basins to final clarifiers.

Each aeration basin will consist of a 52,000 gallon anaerobic zone with mixer, a 52,000 gallon anoxic zone with air diffusers, and a 305,000 gallon aerobic zone with air diffusers. The water depth will be 16 feet. One aeration basin will be provided for Phase 1, with one additional aeration basin provided in Phase 2 and two additional aeration basins provided in Phase 3.

Positive displacement blowers will be located on a concrete pad with a metal roof (no walls). Three blowers will be provided in Phase 1, with an additional three blowers provided in Phase 2. In Phase 3, three blowers will be replaced with larger units.

### **7.3.5 Final Clarifiers**

In the final clarifiers, the activated sludge will settle out of the wastewater. Alum may be added to the activated sludge prior to the final clarifiers if it is necessary to remove additional phosphorus from the flow. Return activated sludge (RAS) will be returned to the aeration basins, and waste activated sludge (WAS) will be directed to the solids dewatering process described below. From the final clarifiers, flow will proceed to the filters.

Each final clarifier will be 73 feet in diameter with a water depth of 16 feet. One clarifier will be

provided for Phase 1, with one additional clarifier provided in Phase 2 and two additional clarifiers provided in Phase 3.

#### **7.3.6 Filters**

Filters will polish the clarified effluent by further removing suspended solids. From the filters, flow will proceed to the ultraviolet disinfection unit. Filter backwash will be returned to the influent lift station.

A cloth media filter with a pump vault will be provided in Phase 1. This filter will have approximately 6 mgd peak filtration capacity. Beginning in Phase 2, all peak flows in excess of 6 mgd will bypass the filter. In Phase 3, an additional cloth media filter will be provided, increasing the total peak filtration capacity to 12 mgd. Peak flows in excess of 12 mgd will bypass the filters in Phase 3.

#### **7.3.7 Ultraviolet Disinfection and Discharge**

Ultraviolet (UV) lamps placed in the flow stream will inactivate harmful microorganisms in the treated effluent prior to discharge. UV disinfection was selected instead of chlorination/dechlorination as the primary disinfectant because it is slightly less expensive, avoids safety hazards from chlorination/dechlorination chemicals, and is highly effective in deactivating cryptosporidium. UV disinfection also avoids the potential disinfection byproducts associated with chloramination. Flow will proceed from ultraviolet disinfection to the discharge outfall, where the treated effluent (reclaimed water) will be discharged to the receiving water.

The UV disinfection system will consist of a structure with two flow channels. In Phase 1, two banks of UV lights will be installed in one channel, and two plant water pumps will be installed at the end of the UV channels. In Phase 2, an additional two banks of UV lights will be installed in the second channel and a hydropneumatic tank will be provided. In Phase 3, more UV modules will be added to the four banks.

#### **7.3.8 Solids Handling**

Excess sludge that accumulates during the treatment process will be pumped to a sludge holding tank. From the sludge holding tank, the sludge will be pumped to a belt press unit for dewatering to a concentration appropriate for landfill disposal.

In Phase 1, solids handling equipment will consist of a 30-foot diameter sludge holding tank with a 16-foot sludge depth, two progressive cavity pumps and positive displacement blowers, a metal belt press building with a one-meter belt press for dewatering solids, and a 60-foot by 60-foot biosolids storage pad. There will be no expansion of solids handling facilities in Phase 2. In Phase 3, an additional 30-foot diameter sludge holding tank, another two progressive cavity pumps and positive displacement blowers, and a two-meter belt press will be provided.

#### **7.3.9 Odor Control**

The preliminary treatment unit will be covered in Phase 1 to reduce ambient odors. Blowers will transport air from the fine screen and grit concentrator areas to a manufactured odor control unit where microorganisms will transform odorous compounds to nonodorous compounds. The “scrubbed” air will be discharged to the atmosphere. The footprint of the preliminary treatment unit will not expand in Phases 2 or 3.

#### **7.3.10 Other**

In Phase 1, a 10-foot by 30-foot prefabricated administration building, a fiberglass enclosure for the alum feed system, and a flexible base gravel road will be provided. A 10-foot by 30-foot prefabricated laboratory building will be provided in Phase 2. In Phase 3, an additional fiberglass enclosure for the alum feed system and additional flexible base gravel road will be provided.

### **7.4 OTHER WASTEWATER TREATMENT PLANTS IN THE PLANNING AREA**

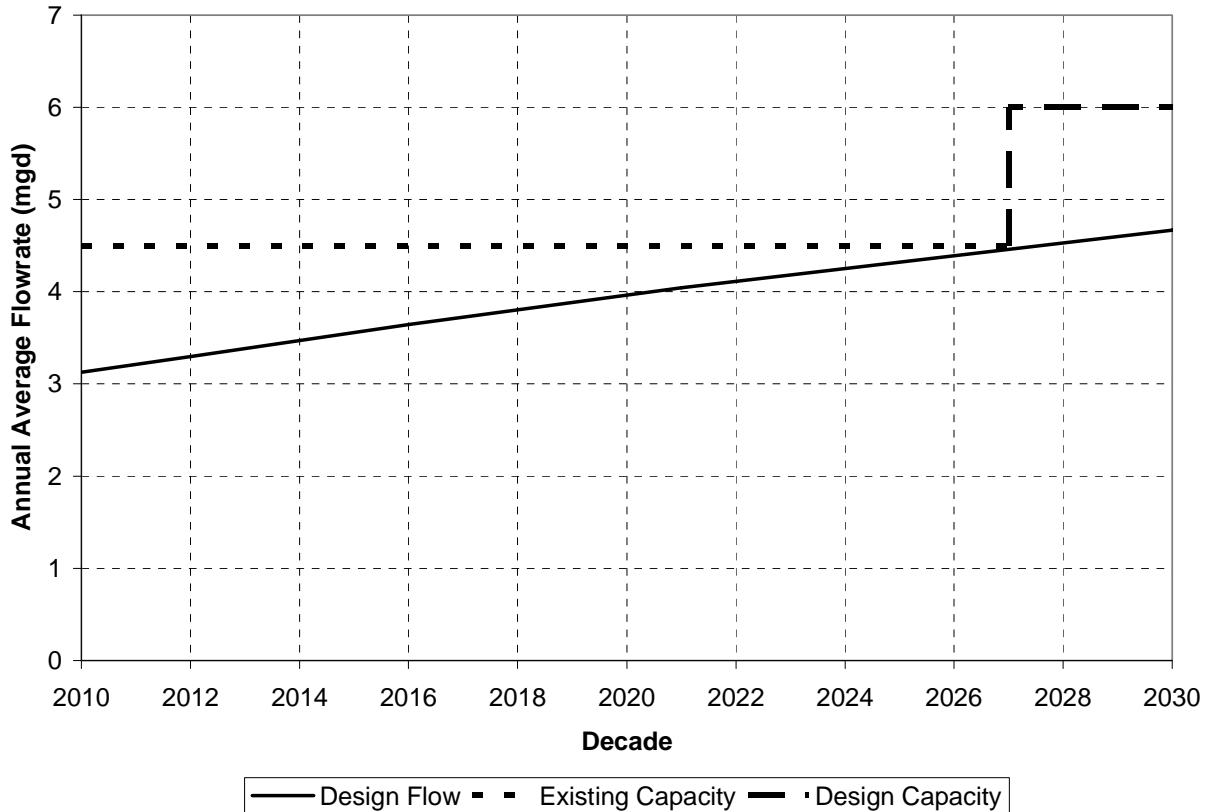
The concept for how each existing WWTP fits into the regional system is outlined below.

#### **7.4.1 Weatherford WWTP**

Most flows generated within the city limits of Weatherford and flows generated in portions of Annetta North and Hudson Oaks would be treated at the Weatherford WWTP (Figure 7-4). Upon completion of Phase 3 of the regional system, it has been assumed that Weatherford will convey part of the flow generated in the Lake Weatherford area to the Weatherford WWTP and that flow in excess of Weatherford’s conveyance capacity will be directed to the Clear Fork WWTP (through Segment M-L in Figure 5-6).

Figure 7-4 shows the projected annual average flow and capacity for the Weatherford WWTP. It is anticipated that Weatherford will need to increase its WWTP capacity by about 2027.

**Figure 7-4  
Weatherford WWTP Projected Annual Average Flow and Capacity**

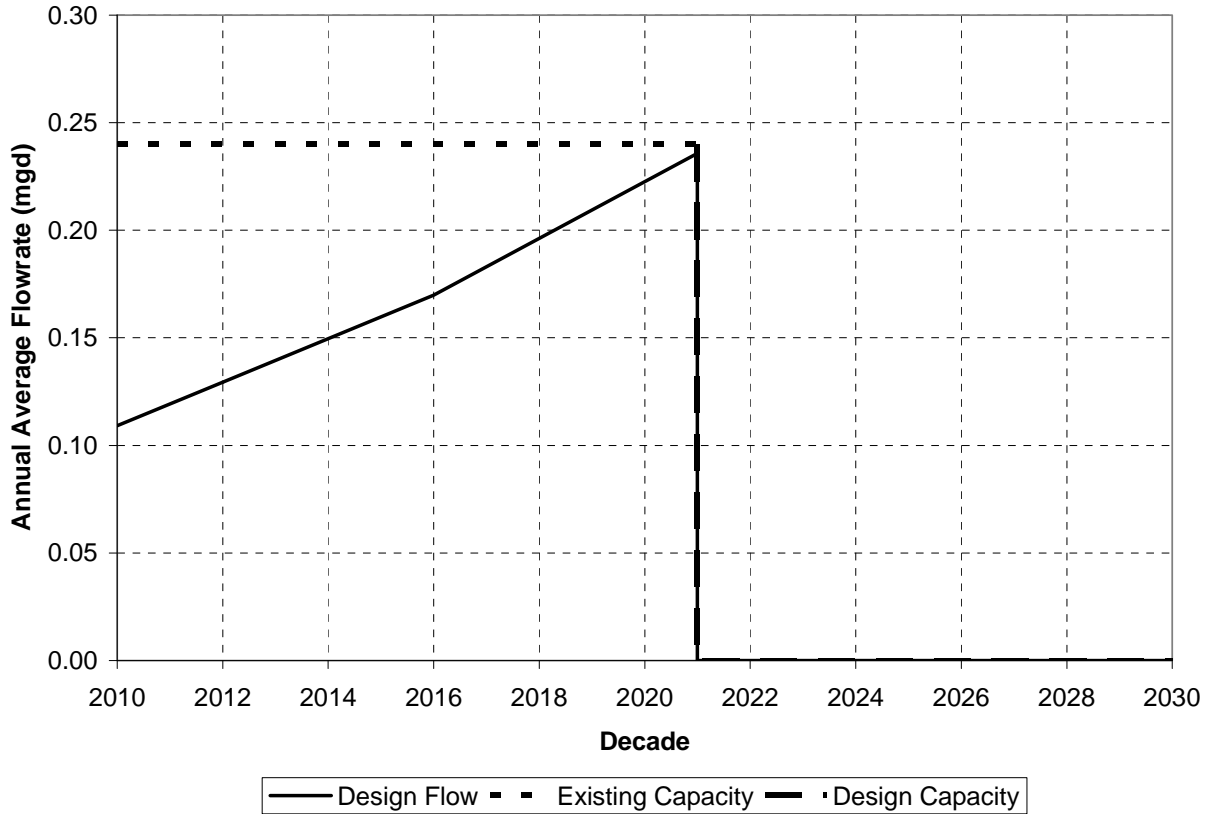


**7.4.2 Willow Park WWTP**

The Willow Park WWTP is projected to treat flow generated from approximately 34 percent of the City’s population, primarily in the northwest part of Willow Park until completion of Phase 3 of the regional system in about 2021 (Figure 7-5). The percentage of population served was estimated using current flows to the Willow Park WWTP and the projected per capita flow contribution. When regional wastewater treatment is available, it is anticipated that the Willow Park WWTP will be taken out of service and that all flows generated in Willow Park will be conveyed to the Clear Fork WWTP for treatment.

Based on projected population growth, it is projected that wastewater flow to the Willow Park WWTP will be just less than the treatment capacity of 0.24 mgd when the regional system becomes available in approximately 2021 (Figure 7-5). If Willow Park extends service to a greater portion of the city or if population growth is faster than projected, then wastewater flow to the plant could exceed the treatment capacity, requiring expansion of the Willow Park WWTP,

**Figure 7-5  
Willow Park WWTP Projected Annual Average Flow and Capacity**

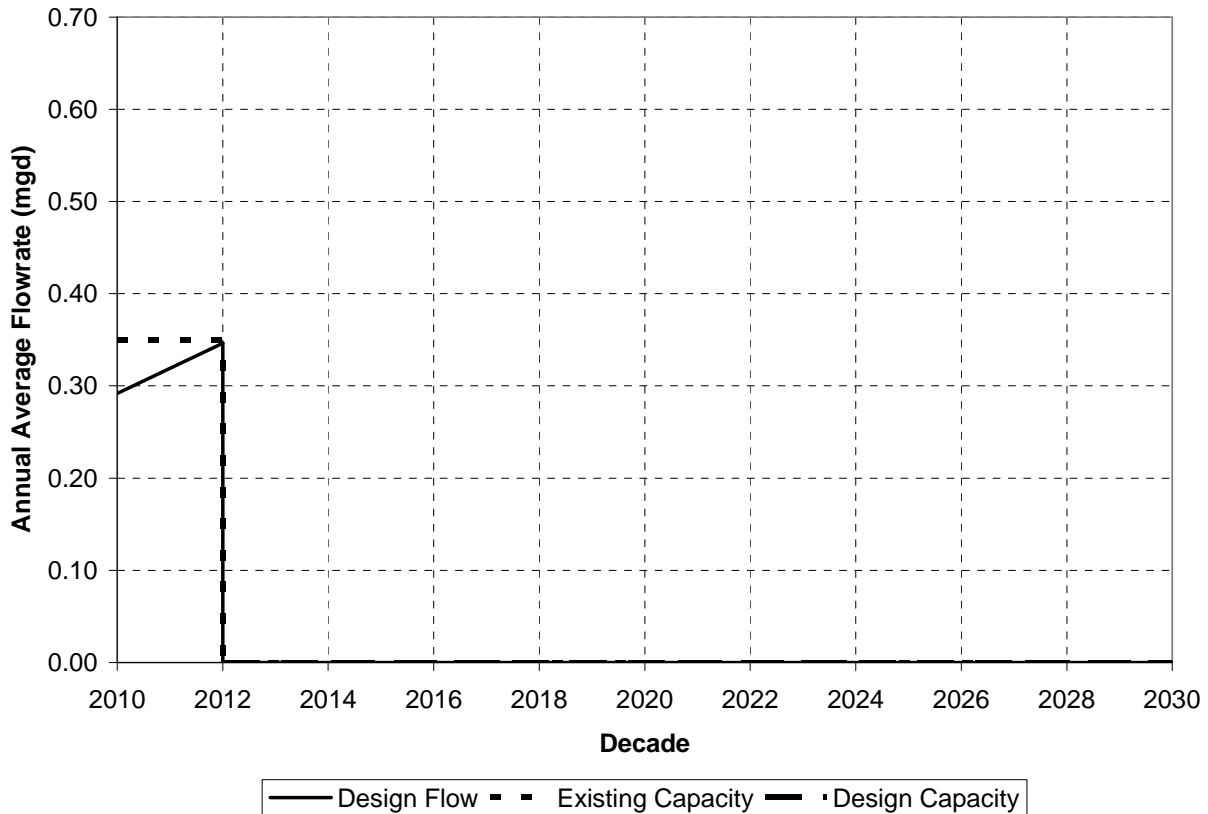


flow management, or acceleration of Phase 3 of the regional wastewater system.

### 7.4.3 Aledo WWTP

Although design of improvements to the Aledo WWTP is in progress, it has been assumed that Aledo will manage future wastewater flows and operate its WWTP without expansion until it can connect to Phase 1 of the regional wastewater system (Figure 7-6). Management of future flows, through control of infiltration and inflow and by limiting new wastewater service, would delay some of the projected growth in wastewater flows until after Aledo has connected to the regional wastewater system. When regional wastewater treatment is available, it is anticipated that the Aledo WWTP will be taken out of service and that all flows generated in Aledo will be conveyed to the Clear Fork WWTP for treatment.

**Figure 7-6  
Aledo WWTP Projected Annual Average Flow and Capacity**

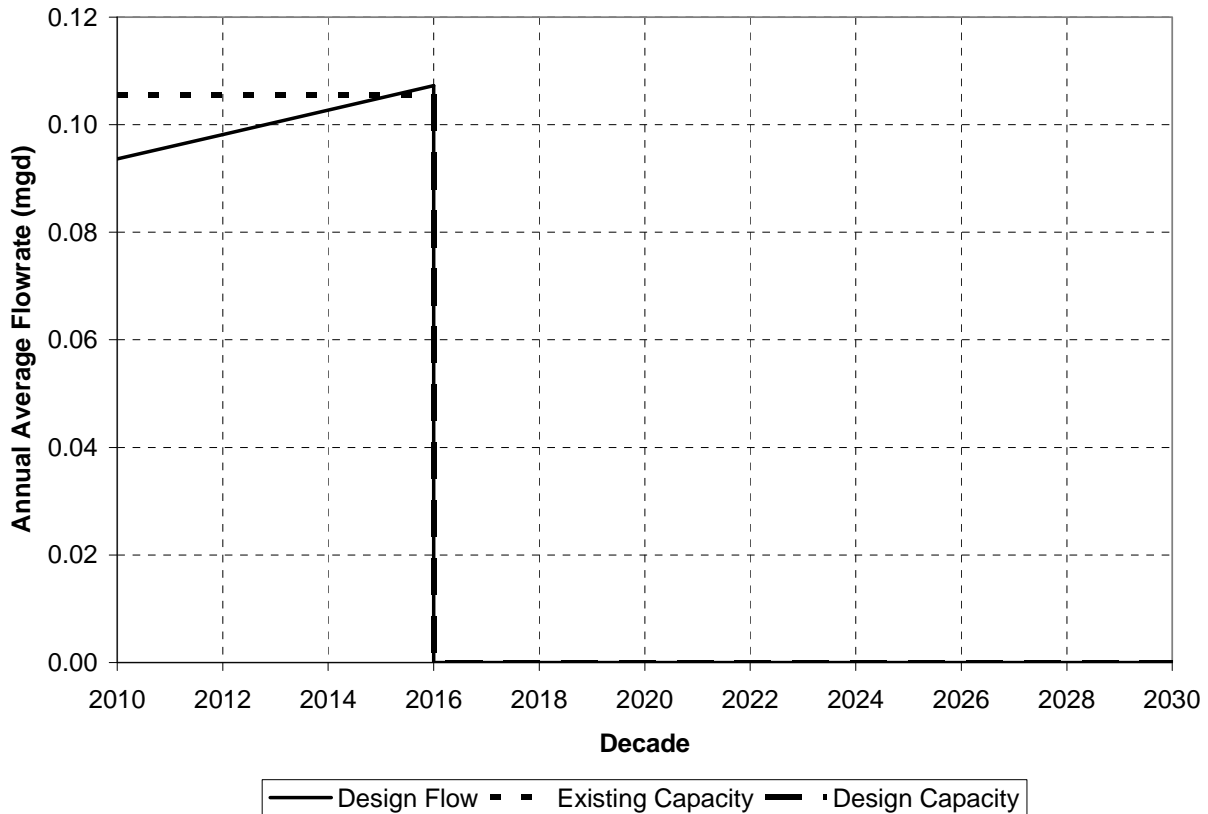


**7.4.4 Deer Creek Waterworks WWTP**

The Deer Creek Waterworks WWTP is projected to treat flow generated in its current service area until completion of Phase 2 of the regional system in about 2016 (Figure 7-7). When regional wastewater treatment is available, it is anticipated that the Deer Creek Waterworks WWTP will be taken out of service and that all flows generated in the Deer Creek Waterworks service area will be conveyed to the Clear Fork WWTP for treatment. Currently, treated wastewater is transported through a force main to the Split Rail Links and Golf Club for reuse. The route of this force main intersects the proposed regional wastewater collection system. It was assumed that the existing facilities can be adapted to transport raw wastewater to the regional collection system.

Based on projected population growth, it is projected that wastewater flow to the Deer Creek Waterworks WWTP will exceed the existing annual average treatment capacity of 0.1056 mgd a

**Figure 7-7  
Deer Creek Waterworks WWTP Projected Annual Average Flow and Capacity**



few months before the regional system becomes available (Figure 7-7). This could be addressed by expanding the treatment capacity, but expansion is unlikely to be economical. Therefore, it has been assumed that Willow Park, which owns the Deer Creek Waterworks system, will manage future flows by one or more of the following methods: reducing infiltration and inflow to the collection system, limiting new wastewater service, upgrading the treatment capacity, and/or accelerating Phase 2 of the regional system.

**7.4.5 Summary**

The concepts expressed in Sections 7.4.1 through 7.4.4 are meant to provide guidance on how to achieve a cost-effective regional wastewater system through 2030. However, it is not possible to predict everything that will occur during the planning period. Valid reasons may arise to justify deviation from these concepts. Valid reasons may include:

- Changes in the economics of regional wastewater treatment. Significant changes in cost from those presented in Appendix B may justify changes to this facilities plan. For example, changing conditions could make it feasible for the regional wastewater service provider to acquire an existing WWTP and to operate it as part of the regional system. The regional wastewater service provider and the WWTP owners should reevaluate the feasibility of continuing to operate an existing WWTP as an element of the regional system prior to taking it out of service.
- Changes in the feasibility of implementing a South Willow Park WWTP to serve Phase 3 of the regional system.
- The desire of a city to provide wastewater service to its citizens over a larger area than assumed above before regional service is available.
- Reclaimed water supply opportunities. If a large reclaimed water customer is identified, it may be beneficial to continue to operate an existing WWTP to provide a nearby source of reclaimed water.

However, deviation from the concepts in this plan should not be pursued if it will adversely affect implementation of a regional wastewater system.



## **CHAPTER 8**

### **POTENTIAL RECLAIMED WATER CUSTOMERS**

The TCEQ has established general requirements, quality criteria, design, and operational requirements for the beneficial use of reclaimed water, which is defined as “domestic or municipal wastewater which has been treated to a quality suitable for a beneficial use.”<sup>bb</sup> These requirements are summarized and potential reclaimed water customers are discussed below.

#### **8.1 REQUIREMENTS FOR THE USE OF RECLAIMED WATER**

The primary requirements for the use of reclaimed water, such as notification of the TCEQ, general requirements, quality standards, and specific uses are summarized briefly below. The full requirements are contained in Texas Administrative Code Title 30, Chapter 210.<sup>bb</sup>

##### **8.1.1 Notification of the TCEQ and Authorization**

Prior to providing reclaimed water for any use, the reclaimed water provider must submit a notification to the TCEQ that includes a description of the intended use of the reclaimed water, including quantity, quality, origin, and intended use; a clear indication of the means of compliance with the Chapter 210 rules; evidence that the reclaimed water use can be terminated if not in compliance with the Chapter 210 rules; and a detailed operation and maintenance plan. After submission of the notification, the provider must obtain written authorization from the Executive Director of the TCEQ.

##### **8.1.2 General Requirements**

The general requirements prohibit the following:<sup>bb</sup>

- Reuse of untreated wastewater;
- Spray irrigation of food crops that may be consumed raw by humans;
- Nuisance conditions resulting from the distribution, use, or storage of reclaimed water;
- Utilization of reclaimed water in a way that degrades groundwater quality to a degree that adversely affects its actual or potential uses;
- Discharge of reclaimed water from storage ponds to waters of the state, except for discharges directly resulting from a rainfall event or in accordance with a TCEQ permit.

The general requirements also address issues such as lining of storage ponds, irrigation using

reclaimed water (e.g., application rates, leaching of salt, etc.), and design criteria for hose bibs, piping, and storage tanks.

### 8.1.3 Quality Standards

Type I reclaimed water may be used in areas where the public may come into contact with the reclaimed water. Type II reclaimed water may be used in areas where the public will not come into contact with the reclaimed water. Table 8-1 shows the quality standards for the two types of reclaimed water.

**Table 8-1  
Quality Standards for Using Reclaimed Water<sup>bb</sup>**

<b>Constituent</b>	<b>Units</b>	<b>Type I Reclaimed Water*</b>	<b>Type II Reclaimed Water* (Pond System)</b>	<b>Type II Reclaimed Water* (Other Systems)</b>
BOD <sub>5</sub> or CBOD <sub>5</sub>	mg/l	5	30	20
		5	n/a	15
Turbidity	NTU	3	n/a	n/a
Fecal Coliform**	CFU/100 ml	20	200	200
Maximum Fecal Coliform***	CFU/100 ml	75	800	800

BOD<sub>5</sub> = five-day biochemical oxygen demand

CBOD<sub>5</sub> = five-day carbonaceous biochemical oxygen demand

NTU = nephelometric turbidity units

CFU = colony-forming units

\* 30-day average unless otherwise specified

\*\* Geometric mean

\*\*\* Single grab sample

Sampling, analysis, reporting, and recordkeeping requirements also apply.

According to the conceptual design presented in Chapter 7, the regional WWTP should produce Type II reclaimed water and will likely produce reclaimed water of Type I quality. However, it is possible that additional filtration and disinfection capacity will be necessary to ensure Type I reclaimed water. This additional treatment capacity can be provided at the end of the conceptual treatment process described in Chapter 7 and can be sized to treat only the reclaimed water needed for Type I uses and not the entire flow through the WWTP.

#### 8.1.4 **Specific Uses**

Examples of Type I reclaimed water uses include:<sup>bb</sup>

- Residential irrigation, including landscape irrigation at individual homes.
- Urban uses, including irrigation of public parks, golf courses with unrestricted public access, school yards, or athletic fields.
- Fire protection, either in internal sprinkler systems or external fire hydrants.
- Irrigation of food crops where the applied reclaimed water may have direct contact with the edible part of the crop, unless the food crop undergoes a pasteurization process.
- Irrigation of pastures for milking animals.
- Maintenance of impoundments or natural water bodies where recreational activities, such as wading or fishing, are anticipated even though the water body was not specifically designed for such a use.
- Toilet or urinal flush water.
- Similar activities where the potential for unintentional human exposure may occur

Examples of Type II reclaimed water uses include:<sup>bb</sup>

- Irrigation of sod farms, silviculture, limited access highway rights of way, and other areas where human access is restricted or unlikely to occur.
- Irrigation of food crops where the reclaimed water is not likely to have direct contact with the edible part of the crop, or where the food crop undergoes pasteurization prior to distribution for consumption.
- Irrigation of animal feed crops other than pasture for milking animals.
- Maintenance of impoundments or natural water bodies where direct human contact is not likely.
- Soil compaction or dust control in construction areas where application procedures minimize aerosol drift to public areas.
- Cooling tower makeup water. Use for cooling towers which produce significant aerosols adjacent to public access areas may have special requirements.
- Irrigation or other non-potable uses of reclaimed water at a wastewater treatment facility.

#### 8.1.5 **Other Requirements**

Other requirements address alternative or pre-existing reclaimed water systems, use of industrial reclaimed water, and use of graywater systems.<sup>bb</sup>

## 8.2 POTENTIAL RECLAIMED WATER CUSTOMERS

Potential reclaimed water customers can be divided into direct reuse customers and indirect

reuse customers. Direct reclaimed water use consists of piping reclaimed water directly to the point of use. Indirect reclaimed water use may consist of discharging reclaimed water to a stream or lake (where it mixes with ambient water) and subsequent withdrawal of the blended natural and reclaimed water for potable or nonpotable uses. Indirect reclaimed water use occurs throughout Texas on both a planned and an unplanned basis. Potential customers for each category include those identified below.

### **8.2.1 Potential Direct Reclaimed Water Customers**

In addition to the general potential reclaimed water uses identified in Section 8.1.4, the Split Rail Links and Golf Club and gas well drillers are also potential direct reclaimed water customers. The probable costs for reclaimed water projects have not been estimated.

#### **8.2.1.1 Split Rail Links and Golf Club**

Currently, the Split Rail Links and Golf Club, located at 2151 Old Annetta Road west of Aledo, uses reclaimed water generated at the Deer Creek Waterworks WWTP to maintain water features and to irrigate the golf course (Type II reclaimed water use). As discussed in Section 7.4.4, it is anticipated that the Deer Creek Waterworks WWTP will be taken out of service by about 2016, which could eliminate reuse of reclaimed water at the Split Rail Links and Golf Club. Therefore, the regional wastewater service provider should explore the feasibility of continuing to provide reclaimed water to the Split Rail Links and Golf Club.

#### **8.2.1.2 Gas Well Drillers**

Water demand from gas well drilling in Parker County has accelerated in the last five years, and drillers are projected to demand a significant amount of water through 2025 (Table 8-2). Survey results show approximately 80 gas well completions in Parker County in 2006.<sup>cc</sup> To fracture geologic strata near a well and increase gas production, drillers generally use about 1.2 and 3.5 million gallons of water per well, for vertical and horizontal wells, respectively,<sup>dd</sup> with horizontal wells expected to predominate in the future.<sup>cc</sup> Water used for well fracturing represents about 90 percent of the water used for gas drilling.<sup>cc</sup>

**Table 8-2  
Projected Percentage of Parker County Groundwater Use for Barnett Shale Gas Wells<sup>dd</sup>**

<b>2000-2005</b>	<b>2005-2010</b>	<b>2010-2015</b>	<b>2015-2020</b>	<b>2020-2025</b>
1%	20-26%	21%	10-13%	13%

Type II reclaimed water is suitable for the fracturing operation, and conversations with gas well drillers indicate an interest in using reclaimed water for well-fracturing if it is economical. One challenge in providing reclaimed water for gas well drilling is the distance from the reclaimed water source to the gas wells, because it can be prohibitively expensive to truck reclaimed water to a well site.

**8.2.1.3 Other**

Other potential direct reclaimed water customers include cities, school districts, and other entities that maintain water features and/or irrigate large tracts of land (parks, athletic fields, croplands, etc.).

**8.2.2 Potential Indirect Reclaimed Water Customers**

Potential indirect reclaimed water customers include the Tarrant Regional Water District, Fort Worth, and Weatherford.

**8.2.2.1 Tarrant Regional Water District**

The Clear Fork WWTP will discharge reclaimed water to the Clear Fork Trinity River, which flows to Benbrook Lake. The Tarrant Regional Water District (TRWD) manages the raw water supply in Benbrook Lake and could be a potential indirect reuse customer. However, previous conversations with TRWD personnel have indicated that TRWD is unwilling to pay for reclaimed water that flows to its lakes. In addition, new or amended water rights may be necessary to divert the reclaimed water from Benbrook Lake.

**8.2.2.2 Fort Worth**

Upon request from Fort Worth, the TRWD releases water into the Clear Fork from Benbrook Lake. Fort Worth then draws the water from the Clear Fork at the Holly Water Treatment Plant (WTP). Depending on the project details, it may be feasible to augment Fort Worth's potable water supply by pumping reclaimed water to the Mary's Creek basin for discharge. Under this scenario, the reclaimed water would flow to Mary's Creek, to the Clear Fork Trinity River

downstream of Benbrook Lake, and to Fort Worth's Holly WTP intake. A portion of the water withdrawn from the Clear Fork at the Holly WTP would be reclaimed water. The fraction of reclaimed water will depend on antecedent weather conditions and how much raw water is released from Benbrook Lake.

A permit to discharge the reclaimed water to the Mary's Creek basin would be necessary. Once reclaimed water is discharged to the Mary's Creek basin, it becomes state water that is subject to downstream appropriation under existing water rights. For Fort Worth to divert the reclaimed water to the Holly WTP, a new or amended water right may also be necessary.

Important non-economic issues associated with such a diversion include the detention time of the reclaimed water in Mary's Creek and the Clear Fork and the composition of the raw water at the Holly WTP. These are two components of the "multiple barrier" approach (Section 6.1.3) to management of unknown constituents in reclaimed water.

#### **8.2.2.3 Weatherford**

Depending on the project details, it may be become feasible to augment Weatherford's potable water supply by pumping reclaimed water to Lake Weatherford for discharge and blending with natural water. A permit to discharge the reclaimed water to Lake Weatherford would be necessary. For Weatherford to divert the reclaimed water from Lake Weatherford, a new or amended water right may also be necessary. Important non-economic issues associated with such a diversion include the detention time and percentage of the reclaimed water in Lake Weatherford.

## **CHAPTER 9**

### **OPINIONS OF PROBABLE COST**

Opinions of capital, annual, and unit costs were derived from the conceptual designs for the regional collection system (Chapter 5 and Appendix C) and the Clear Fork WWTP (Chapter 7). The opinions of cost were developed using the General Cost Guidelines presented in Appendix B.

#### **9.1 OPINION OF PROBABLE CAPITAL COST**

An opinion of probable capital cost was developed for a regional wastewater conveyance system and the Clear Fork WWTP (Table 9-1). Construction costs include contractors' mobilization, overhead, and profit. Opinions of probable construction cost for regional interceptors and force mains, lift stations, and wastewater treatment facilities have been listed separately. Costs for engineering, legal services, construction management, contingencies, land and rights-of-way, permitting, and mitigation are also listed separately. All costs are shown in 2007 dollars.

The cost of wastewater discharge permitting is highly variable and depends on the complexity of the permitting process (*i.e.*, the amount of modeling required to support the permit application, the amount and type of opposition to the permit, etc.). This cost has not been included in the opinion of probable capital cost in Table 9-1. The cost of wastewater discharge permitting will likely be small compared to the total capital cost.

The planning period extends through 2030, and the facilities for Phases 1 through 3 provide sufficient treatment for projected flows through 2030. However, in about 2030, the WWTP will need expansion to provide capacity for future flows. This additional expansion is shown in Table 9-1 as Phase 4, which consists primarily of increased pumping capacity at lift stations and an additional 1.25 mgd of wastewater treatment capacity at the Clear Fork WWTP.

The total opinion of probable capital cost for regional wastewater facilities through 2030 is approximately \$84.2 million.

The cost of local collection systems to convey wastewater to the regional collection system and the cost for Weatherford to upgrade, operate, and maintain its wastewater collection and

**Table 9-1  
Opinion of Probable Capital Cost for Eastern Parker County Regional Wastewater Facilities (2007 Dollars)**

<b>Category</b>	<b>Item</b>	<b>Phase 1 (2012)</b>	<b>Phase 2 (2016)</b>	<b>Phase 3 (2021)</b>	<b>Phase 4 (2030)</b>	<b>Total</b>
Interceptors and Force Mains	Construction Cost	\$6,182,376	\$3,796,375	\$15,710,135	\$0	\$25,688,885
	Right of Way	\$777,081	\$241,767	\$594,061	\$0	\$1,612,909
Lift Stations	Construction Cost	\$324,834	\$177,173	\$696,320	\$290,773	\$1,489,100
	Land	\$40,000	\$0	\$20,000	\$0	\$60,000
Wastewater Treatment	New WWTP	\$8,295,000	\$0	\$0	\$0	\$8,295,000
	WWTP Expansion	\$0	\$4,400,000	\$8,930,000	\$8,295,000	\$21,625,000
	Land	\$400,000	\$0	\$0	\$0	\$400,000
<i>Construction Cost Subtotal</i>		<i>\$16,019,290</i>	<i>\$8,615,315</i>	<i>\$25,950,517</i>	<i>\$8,585,773</i>	<i>\$59,170,895</i>
Engineering, Legal, Construction Management, and Contingencies	Interceptors and Force Mains (30%)	\$1,854,713	\$1,138,912	\$4,713,041	\$0	\$7,706,666
	Lift Stations (35%)	\$113,692	\$62,011	\$243,712	\$101,770	\$521,185
	Wastewater Treatment (35%)	\$2,903,250	\$1,540,000	\$3,125,500	\$2,903,250	\$10,472,000
Permitting and Mitigation	Interceptors, Lift Stations, WWTP Site	\$177,627	\$47,683	\$196,877	\$3,489	\$425,676
	WWTP Discharge Permit	NA*	NA	NA	NA	NA
<i>Capital Cost Subtotal</i>		<i>\$21,068,571</i>	<i>\$11,403,921</i>	<i>\$34,229,647</i>	<i>\$11,594,283</i>	<i>\$78,296,422</i>
Interest During Construction		\$1,647,436	\$891,718	\$2,676,553	\$667,750	\$5,883,457
<b>Capital Cost Total</b>		<b>\$22,716,007</b>	<b>\$12,295,639</b>	<b>\$36,906,200</b>	<b>\$12,262,032</b>	<b>\$84,179,878</b>

\*Costs for WWTP discharge permits are highly variable and have not been included in the opinion of capital cost.



treatment facilities have not been included in the opinion of probable capital cost for the regional system.

## **9.2 OPINION OF PROBABLE ANNUAL COST**

An opinion of annual cost was developed for a regional wastewater conveyance system and the Clear Fork WWTP (Figure 9-1). Annual cost items include debt service on capital expenditures and operation and maintenance (O&M) costs. A detailed opinion of annual costs is presented in Appendix D. All costs are shown in 2007 dollars.

In the opinion of probable annual cost, financing of capital costs has been handled in two different ways: standard financing or a combination of 50 percent standard financing and 50 percent financing from the State Participation Program (sponsored by the TWDB). Standard financing was assumed to carry an interest rate of 4.5 percent per year<sup>ee</sup> for a term of 20 years.

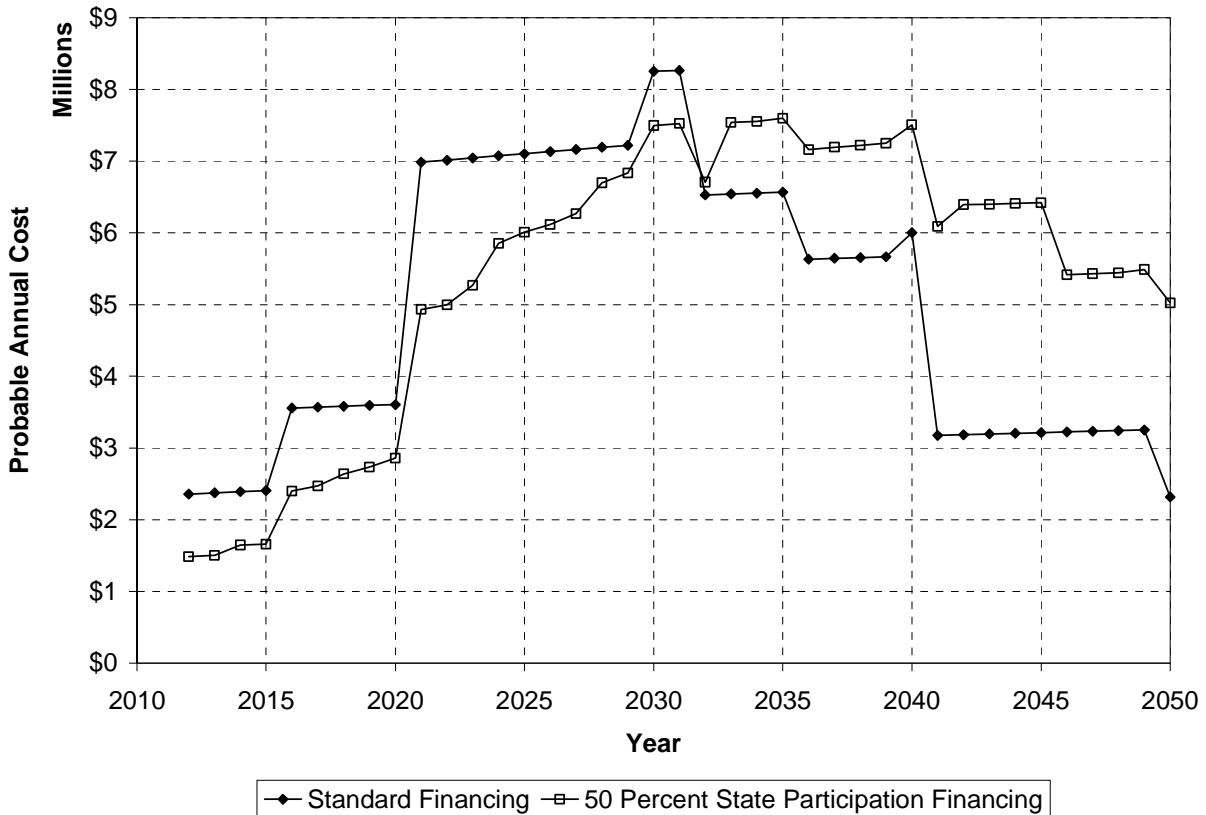
The benefits of financing through the State Participation Program include:

- Payments are deferred until the customer base grows into the added capacity,
- The TWDB does not accrue interest on the deferred interest portion, and
- Optimizing regional projects reduces the necessity and added expense of building new structures or replacing undersized structures in the future.

The TWDB assumes a temporary ownership interest in projects financed through the State Participation Program. For a regional wastewater project, the TWDB can fund up to 50 percent of the costs with the requirement that at least 50 percent of the total capacity of the proposed project will serve existing needs. It has been assumed that State Participation Program financing will be available at an interest rate of 5.75 percent per year<sup>ff</sup> for a term of 35 years.

For each financing method, Figure 9-1 shows a graph of the probable annual costs throughout the planning period. Although the planning period extends only through 2030, the opinion of probable annual cost has been projected through 2050 to show the impact of the different financing methods. For both methods, the annual costs are projected to increase with each new phase of the regional wastewater system (2012, 2016, 2021, 2030, etc.). In the interim years, increases in annual cost are due to the gradually increasing flow treated at the Clear Fork WWTP. As debt service expires, the annual costs are projected to decrease substantially.

**Figure 9-1  
Opinion of Probable Annual Cost for Eastern Parker County Regional Wastewater  
Facilities (2007 Dollars)**



With standard financing, the initial annual costs are greater than with 50 percent State Participation financing. However, with standard financing, the debt is repaid significantly sooner than with 50 percent State Participation financing, leading to lower annual costs in later decades. As evidenced by Figure 9-1, State Participation financing makes the project more affordable in the early years, with this benefit being repaid in later years.

No revenue from potential reuse projects has been included in the opinion of probable annual cost for the regional system.

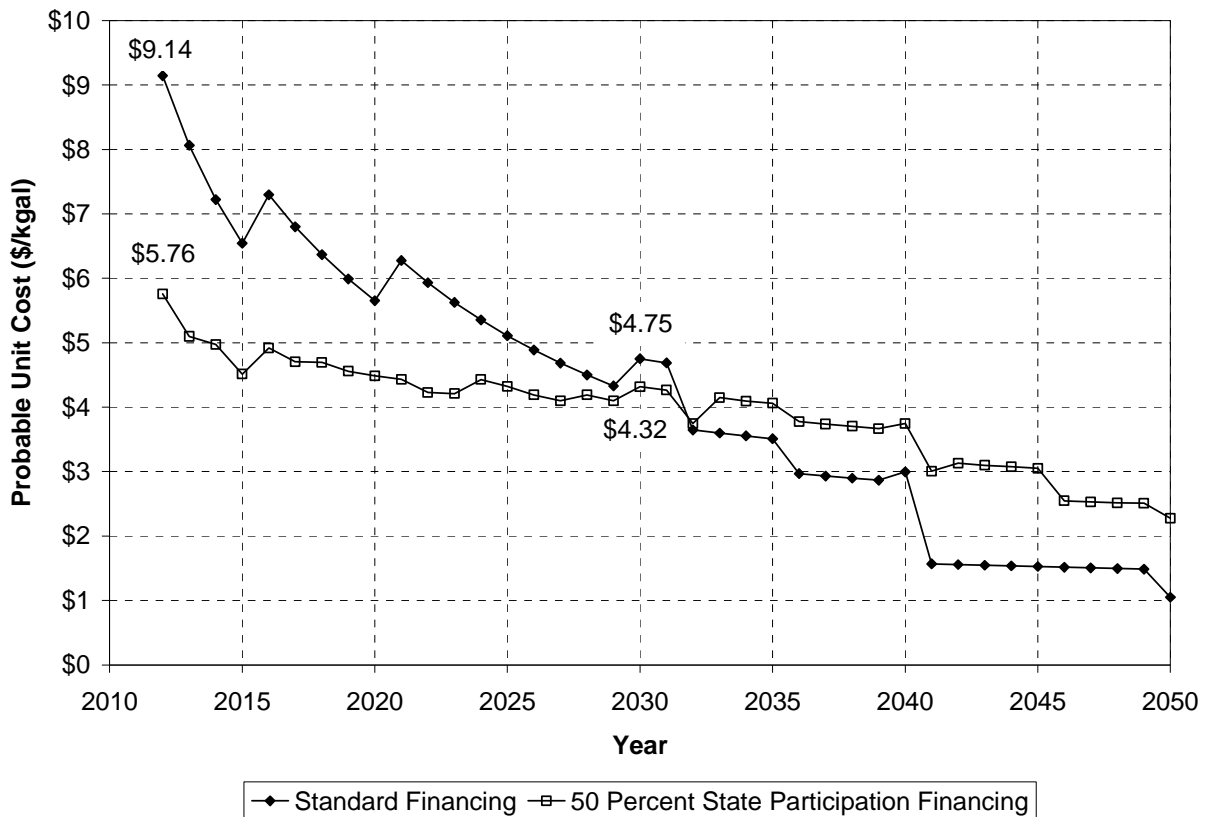
**9.3 OPINION OF PROBABLE UNIT COST**

Although the opinion of probable annual cost is useful in showing the projected financial obligations of a regional wastewater system, it does not fully convey whether the system is affordable. Therefore, an opinion of probable unit cost was also developed. The opinion of

probable unit cost is the probable annual cost normalized by the projected wastewater flowrate.

Figure 9-2 similarly demonstrates that 50 percent State Participation financing makes the project more affordable. The opinion of probable unit cost is less than \$5 per thousand gallons by about 2014.

**Figure 9-2**  
**Opinion of Probable Unit Cost for Eastern Parker County Regional Wastewater System**  
**(2007 Dollars)**



## **CHAPTER 10**

### **IMPLEMENTATION PLAN**

A broad discussion of the actions necessary to implement the Eastern Parker County Regional Wastewater Facilities Plan (the Plan) is presented by phase in the following sections. An implementation schedule is presented in Figure 10-1.

#### **10.1 PHASE 1**

Phase 1 actions include continuing Participant meetings, identifying a regional wastewater service provider, negotiating service agreements with the Participants, planning and constructing local collection systems,<sup>36</sup> designing regional wastewater facilities, obtaining financing, acquiring a WWTP site, permitting a WWTP and conveyance facilities, and constructing regional facilities. Phase 1 is expected to be complete by 2012.

##### **10.1.1 Participants' Committee**

Representatives of the Participants have met on a regular basis to oversee development of the Plan. To successfully implement the regional wastewater system, the Participants must continue to meet regularly to move the project forward in a timely manner.

##### **10.1.2 Identify Regional Wastewater Service Provider**

As a first step, the Participants' Committee must identify the regional wastewater service provider (Service Provider). No analysis of potential regional wastewater service providers has been performed as part of this Facilities Plan, but candidates may include PCUD, the Trinity River Authority, Fort Worth, and Weatherford. These entities have regional authority and/or extensive wastewater treatment experience. A new regional entity could also be created, although this may delay implementation.

##### **10.1.3 Negotiate Service Agreements with Participants**

The next step is for the Service Provider and the Participants to negotiate agreements for wastewater service. Issues will include timing of service and equitable distribution of system

---

<sup>36</sup> This will be the responsibility of the local entity.





costs: Some Participants will receive wastewater service in Phase 1, but others will not receive wastewater service until later phases. To address this issue, a two-stage cost structure could be utilized. In the first stage, all Participants would “buy in” to the regional system to assure future wastewater service at a certain capacity. In the second stage, Participants receiving wastewater service would pay fees related to the actual volume of wastewater treated.

#### 10.1.4 **Plan and Construct Local Collection Systems**

In this Plan, regional wastewater facilities have been sized to convey and treat 100 percent of the projected wastewater generated in each contributing city. However, actual flows to the regional system may be different.<sup>37</sup> In each phase, it is important for the Participants to refine projections of wastewater flow to the regional wastewater system so that regional facilities can be properly sized. In Phase 1, Aledo, Annetta North, Annetta South, and Fort Worth must plan<sup>38</sup> and construct local collection systems as necessary to convey wastewater to the regional collection system or the Weatherford collection system, as necessary (Figure 5-6). The timing of this effort should be coordinated with the financing, design, and construction of the regional conveyance and treatment facilities.

#### 10.1.5 **Design Phase 1 Facilities**

This Plan provides a conceptual design for a regional wastewater conveyance and treatment system. The Service Provider should retain an engineer to perform the preliminary and final design work necessary to develop the concepts into final facility sizes, locations, and construction plans.

#### 10.1.6 **Obtain Financing**

Supported by the service agreements and the preliminary design, the Service Provider must obtain financing for construction of the regional wastewater facilities. Sources of financing may include one or more of the following:

---

<sup>37</sup> Continued use of septic systems in some areas and faster or slower growth could change the flow projections.

<sup>38</sup> Local collection system planning must include resolution of any conflicts regarding local retail service areas and CCNs.

- Market-rate financing such as bonds or bank loans
- Texas Water Development Board (TWDB)<sup>99</sup>
  - Clean Water State Revolving Fund Loan Program
  - Rural Water Assistance Fund Program
  - State Participation in Regional Water and Wastewater Facilities Program
  - Water and Wastewater Loan Program
- Texas Department of Agriculture
  - Texas Capital Fund Infrastructure Development Program<sup>hh</sup>
  - Rural Municipal Finance Program<sup>ii</sup>

Each of the programs mentioned above has eligibility rules that may limit the funding available for the regional wastewater system.

Initial analysis in Chapter 9 indicates that State Participation financing from the TWDB can significantly reduce the initial costs of a regional wastewater system.

#### 10.1.7 **Acquire Property for Clear Fork WWTP**

Once financing is obtained, the Service Provider must acquire property for the Clear Fork WWTP. Although the example site plan shows a required site area of approximately 10.5 acres, which includes a buffer of 150 feet between any treatment facility and the property line, it is advisable to acquire a larger site to allow for expansion beyond Phase 3 and/or to allow for a larger buffer area.

#### 10.1.8 **Permit Clear Fork WWTP**

The Service Provider must acquire a permit to discharge treated effluent from the Clear Fork WWTP into the Clear Fork Trinity River. This effort will include filing a permit application, conducting water quality modeling studies to support the proposed effluent water quality requirements, and meetings with the Texas Commission on Environmental Quality (TCEQ). The Service Provider may also require legal assistance if the permit is contested.

#### 10.1.9 **Permit Wastewater Conveyance Facilities**

The Service Provider must obtain the proper permits from the U.S. Army Corps of Engineers prior to construction of wastewater conveyance facilities. At a minimum, this will include Section 404 permits.



#### 10.1.10 **Construct Phase 1 Facilities**

Phase 1 of the regional wastewater system would include construction of facilities at the Clear Fork WWTP to provide a treatment capacity of 1.25 mgd and facilities necessary to convey wastewater from Aledo (D and E in Figure 5-6), Annetta South (C), and Fort Worth (X and Y) to the Clear Fork WWTP and to convey wastewater from Annetta North to the Weatherford WWTP (AA).

#### 10.1.11 **Retire Aledo WWTP**

It is anticipated that the Aledo WWTP will be taken out of service upon implementation of Phase 1. However, the Service Provider should evaluate whether this plant could be used in conjunction with the regional system to provide reclaimed water to local users.

### **10.2 PHASE 2**

Phase 2 actions include reevaluating the potential for a South Willow Park WWTP to serve Phase 3 customers, planning and constructing local collection systems for Phase 2,<sup>36</sup> expanding regional wastewater facilities for Phase 2, and retiring the Deer Creek Waterworks WWTP. Phase 2 is expected to be complete by 2016.

#### 10.2.1 **Reevaluate the Potential for a South Willow Park WWTP to Serve Phase 3**

Due to depressed dissolved oxygen in the Clear Fork Trinity River near the South Willow Park site and the potential for public opposition to a South Willow Park WWTP, the Alternative A system configuration, which included a South Willow Park WWTP, was not recommended. Instead, it was recommended that Willow Park and portions of Hudson Oaks and Annetta North connect to the regional wastewater system in approximately 2021 as part of Phase 3. However, if regional wastewater service for Phase 3 can be provided at an earlier date from a South Willow Park WWTP, there may be substantial advantages to these cities, such as reducing the number of new septic systems that are installed and reducing the need for expanded treatment capacity at the Willow Park WWTP.

During Phase 2, the Service Provider should reevaluate the feasibility of providing regional wastewater service to Phase 3 from a South Willow Park WWTP. Should this plant become feasible, the Service Provider could accelerate implementation of Phase 3 by providing wastewater treatment at a South Willow Park WWTP.

### **10.2.2 Plan and Construct Local Collection Systems for Phase 2**

In Phase 2, Annetta and Annetta South must plan<sup>38</sup> and construct local collection systems as necessary to convey wastewater to the regional collection system. It is important to refine projections of flow to the regional system so that regional facilities will be properly sized. The timing of this effort should be coordinated with the financing, design, and construction of the regional conveyance and treatment facilities.

### **10.2.3 Design Phase 2 Facilities**

This Plan provides a conceptual design for a regional wastewater conveyance and treatment system. The Service Provider should retain an engineer to perform the preliminary and final design work necessary to develop the concepts into final facility sizes, locations, and construction plans.

### **10.2.4 Construct Phase 2 Facilities**

Phase 2 of the regional wastewater system would include construction of facilities at the Clear Fork WWTP to provide a total treatment capacity of 2.5 mgd and facilities necessary to convey wastewater from Annetta South (V in Figure 5-6), Annetta (U and W), and Annetta North (P) to the Clear Fork WWTP.

### **10.2.5 Retire Deer Creek Waterworks WWTP**

It is anticipated that the Deer Creek Waterworks WWTP will be taken out of service in upon implementation of Phase 2. However, the Service Provider should evaluate whether this plant could be used in conjunction with the regional system to provide reclaimed water to local users.

## **10.3 PHASE 3**

Phase 3 actions include planning and constructing local collection systems,<sup>36</sup> expanding regional wastewater facilities, and retiring the Willow Park and Aledo WWTPs. Phase 3 is expected to be complete by 2021.

### **10.3.1 Plan and Construct Local Collection Systems**

In Phase 3, Annetta North, Hudson Oaks, and Willow Park must plan<sup>38</sup> and construct local collection systems as necessary to convey wastewater to the regional collection system. It is important to refine projections of flow to the regional system so that regional facilities will be

properly sized. The timing of this effort should be coordinated with the financing, design, and construction of the regional conveyance and treatment facilities.

### **10.3.2 Design Phase 3 Facilities**

This Plan provides a conceptual design for a regional wastewater conveyance and treatment system. The Service Provider should retain an engineer to perform the preliminary and final design work necessary to develop the concepts into final facility sizes, locations, and construction plans.

### **10.3.3 Construct Phase 3 Facilities**

Phase 3 of the regional wastewater system would include construction of treatment facilities at the Clear Fork WWTP<sup>39</sup> to provide a total treatment capacity of 5 mgd and facilities necessary to convey wastewater from Willow Park (K, J, and S in Figure 5-6), Hudson Oaks (N, O, and R), and Annetta North (P) to the regional WWTP(s); to provide additional conveyance capacity (parallel lines) in the southern portion of the regional system if necessary; and to convey additional wastewater from Hudson Oaks (AC) to the Weatherford WWTP.

### **10.3.4 Retire Willow Park WWTP**

It is anticipated that the Willow Park WWTP will be taken out of service upon implementation of Phase 3. However, the Service Provider should evaluate whether this plant could be used in conjunction with the regional system to provide reclaimed water to local users.

## **10.4 ALL PHASES**

During all phases, the Service Provider should continue to identify potential reclaimed water customers and develop plans to provide service to these customers. Revenue from reclaimed water sales could offset the wastewater conveyance and treatment costs borne by the Participants. This potential revenue was not included in the opinions of cost in Chapter 9.

## **10.5 PROJECT TIMING**

The timing of the implementation of Phase 1 is critical to Aledo. Although design of

---

<sup>39</sup> Or the South Willow Park WWTP, should it prove feasible (Section 10.2.1).

improvements to the Aledo WWTP is in progress, it has been assumed that Aledo will manage future wastewater flows and operate its WWTP without expansion until it can connect to Phase 1 of the regional wastewater system. Management of future flows, through control of infiltration and inflow and by limiting new wastewater service, would delay some of the projected growth in wastewater flows until after Aledo has connected to the regional wastewater system. Therefore, it is important to Aledo that Phase 1 be completed as soon as possible.

The timing of Phase 2 is critical to the Deer Creek Waterworks WWTP. It is projected that wastewater flow to the Deer Creek Waterworks WWTP will exceed the existing annual average treatment capacity of 0.1056 mgd a few months before the regional system becomes available. This could be addressed by expanding the treatment capacity, but expansion is unlikely to be economical. Therefore, it has been assumed that Willow Park, which owns the Deer Creek Waterworks system, will manage future flows by one or more of the following methods: reducing infiltration and inflow to the collection system, limiting new wastewater service, upgrading the treatment capacity, and/or accelerating Phase 2 of the regional system.

The timing of Phase 3 is critical to Willow Park. It is projected that wastewater flow to the Willow Park WWTP will be just less than the treatment capacity of 0.24 mgd when the regional system becomes available in approximately 2021. If Willow Park extends service to a greater portion of the city or if population growth is faster than projected, then wastewater flow to the plant could exceed the treatment capacity, requiring expansion of the Willow Park WWTP, flow management, or acceleration of Phase 3 of the regional wastewater system.

The timing of the Phase 3 is also important to Hudson Oaks and Annetta North, which cannot connect to the regional wastewater system until Phase 3 is completed. Should wastewater service become necessary before Phase 3 is completed, these cities will have to identify and implement interim measures.

## CHAPTER 11

### REFERENCES

---

<sup>a</sup> Texas Administrative Code, Title 30, Chapter 317, "Design Criteria for Sewerage Systems," Section 317.1(b)(4)(B), accessed online at <http://www.tceq.state.tx.us/assets/public/legal/rules/rules/pdflib/317%60.pdf>, April 2007.

<sup>b</sup> Texas Administrative Code, Title 30, Chapter 291 Subchapter G, "Certificates of Convenience and Necessity," accessed online at <http://www.tceq.state.tx.us/assets/public/legal/rules/rules/pdflib/317%60.pdf>, May 2007.

<sup>c</sup> Texas Administrative Code, Title 30, Chapter 305, "Consolidated Permits," Section 305.126(a), accessed online at <http://www.tceq.state.tx.us/assets/public/legal/rules/rules/pdflib/305f.pdf>, May 2007.

<sup>d</sup> Upper West Fork and Clear Fork, Trinity River Basin, Water Quality and Regional Facility Planning Study, prepared for the Tarrant County Water Control and Improvement District Number One and the Texas Water Development Board by Alan Plummer and Associates, Inc., August 1988.

<sup>e</sup> Facilities Plan, Lake Weatherford Regional Wastewater System, prepared for the Trinity River Authority by Alan Plummer and Associates, Inc., December 1988.

<sup>f</sup> Technical Memorandum, City of Weatherford Sanchez Creek Sewer Service Evaluation, prepared for the City of Weatherford by Alan Plummer Associates, Inc., August 2003.

<sup>g</sup> Regional Water Supply and Wastewater Service Study for Johnson and Parker Counties, Phase I, prepared for the Brazos River Authority and the Tarrant Regional Water District by Freese and Nichols, Inc., February 2004.

---

<sup>h</sup> Texas Water Development Board, “2006 Regional Water Plan City Population Projections for 2000-2060,” accessed online at [http://www.twdb.state.tx.us/data/popwaterdemand/2003Projections/Population%20Projections/STATE\\_REGION/City\\_Pop.htm](http://www.twdb.state.tx.us/data/popwaterdemand/2003Projections/Population%20Projections/STATE_REGION/City_Pop.htm), February 2007.

<sup>i</sup> North Central Texas Council of Governments Research and Information Services, “North Central Texas 2030 Demographic Forecast,” April 2003.

<sup>j</sup> North Central Texas Council of Governments Research and Information Services, “2006 Current Population Estimates,” March 2006.

<sup>k</sup> North Central Texas Council of Governments Research and Information Services, “2005 Current Population Estimates,” April 2005.

<sup>l</sup> North Central Texas Council of Governments Research and Information Services, “2003 Current Population Estimates,” April 2003.

<sup>m</sup> North Central Texas Council of Governments Research and Information Services, “2002 Current Population Estimates,” April 2002.

<sup>n</sup> North Central Texas Council of Governments Research and Information Services, “2001 Current Population Estimates,” May 2001.

<sup>o</sup> United States Census Bureau, “Population Estimates,” accessed online at <http://www.census.gov/popest/cities/tables/SUB-EST2005-04-48.xls>, February 2007.

<sup>p</sup> Population projections performed for the City of Aledo by Belcheff Associates, Inc.

<sup>q</sup> United States Environmental Protection Agency, “Water Discharge Permits (PCS) Query Form,” accessed online at [http://www.epa.gov/enviro/html/pcs/pcs\\_query\\_java.html](http://www.epa.gov/enviro/html/pcs/pcs_query_java.html), February 2007.

---

<sup>r</sup> Texas Water Development Board, "Texas Historical Water Use Data," accessed online at <http://www.twdb.state.tx.us/data/popwaterdemand/2003Projections/HistoricalWaterUse.asp>, February 2007.

<sup>s</sup> Texas Administrative Code, Title 30, Chapter 317, "Design Criteria for Sewerage Systems," Section 317.2(a)(1), accessed online at <http://www.tceq.state.tx.us/assets/public/legal/rules/rules/pdflib/317%60.pdf>, April 2007.

<sup>t</sup> 2004 Texas 303(d) List, Texas Commission on Environmental Quality, accessed online at [http://www.tceq.state.tx.us/assets/public/compliance/monops/water/04twqi/04\\_303d.pdf](http://www.tceq.state.tx.us/assets/public/compliance/monops/water/04twqi/04_303d.pdf), February 2007.

<sup>u</sup> 31 Texas Administrative Code Chapter 307.

<sup>v</sup> Conversation with TCEQ water quality staff, December 2006.

<sup>w</sup> 2004 Texas Water Quality Inventory, Texas Commission on Environmental Quality, accessed online at [http://www.tceq.state.tx.us/assets/public/compliance/monops/water/assessments/04\\_0831\\_fact.pdf](http://www.tceq.state.tx.us/assets/public/compliance/monops/water/assessments/04_0831_fact.pdf), February 2007.

<sup>x</sup> Presented at a meeting of the Texas Commission on Environmental Quality Nutrient Criteria Development Advisory Work Group, September 26, 2005, Austin, Texas.

<sup>y</sup> Texas Administrative Code, Title 30, Chapter 317, "Design Criteria for Sewerage Systems," Section 317.4(a), accessed online at <http://www.tceq.state.tx.us/assets/public/legal/rules/rules/pdflib/317%60.pdf>, April 2007.

---

<sup>z</sup> Texas Administrative Code, Title 30, Chapter 317, “Design Criteria for Sewerage Systems,” accessed online at <http://www.tceq.state.tx.us/assets/public/legal/rules/rules/pdflib/317%60.pdf>, April 2007.

<sup>aa</sup> Texas Administrative Code, Title 30, Chapter 309, “Domestic Wastewater Effluent Limitation and Plant Siting,” Section 309.13, accessed online at <http://www.tceq.state.tx.us/assets/public/legal/rules/rules/pdflib/309b.pdf>, May 2007.

<sup>bb</sup> Texas Administrative Code, Title 30, Chapter 210, “Use of Reclaimed Water.” Accessed online at <http://www.tceq.state.tx.us/rules/indxpdf.html#210>, May 2007.

<sup>cc</sup> Gas Technology Institute, Fort Worth Basin/Barnett Shale Natural Gas Play: An Assessment of Present and Projected Fresh Water Use, prepared by Texerra, April 2007. Accessed online at: <http://www.texerra.com/Barnetthydro.pdf>.

<sup>dd</sup> Texas Water Development Board, [Assessment of Groundwater Use in the Northern Trinity Aquifer Due to Urban Growth and Barnett Shale Development](#), prepared by R.W. Harden Associates, Inc., et al, January 2007. Accessed online at: [http://www.twdb.state.tx.us/RWPG/rpgm\\_rpts/0604830613\\_BarnetShale.pdf](http://www.twdb.state.tx.us/RWPG/rpgm_rpts/0604830613_BarnetShale.pdf).

<sup>ee</sup> Texas Water Development Board, “Lending Rate Memorandum, March 9, 2007,” accessed online at [http://www.twdb.state.tx.us/assistance/financial/fin\\_infrastructure/interest.asp](http://www.twdb.state.tx.us/assistance/financial/fin_infrastructure/interest.asp), March 2007.

<sup>ff</sup> Texas Water Development Board, “TWDB State Participation Program,” accessed online at [http://www.twdb.state.tx.us/assistance/financial/fin\\_infrastructure/StateParticipation.asp](http://www.twdb.state.tx.us/assistance/financial/fin_infrastructure/StateParticipation.asp), March 2007.



---

<sup>99</sup> Texas Water Development Board, "TWDB Financial Assistance Programs," accessed online at [http://www.twdb.state.tx.us/assistance/financial/financial\\_main.asp#Public](http://www.twdb.state.tx.us/assistance/financial/financial_main.asp#Public), March 2007.

<sup>hh</sup> Texas Department of Agriculture, "Texas Capital Fund Infrastructure Development," accessed online at [http://www.agr.state.tx.us/agr/program\\_render/0,1987,1848\\_6054\\_0\\_0,00.html?channelld=6054](http://www.agr.state.tx.us/agr/program_render/0,1987,1848_6054_0_0,00.html?channelld=6054), April 2007.

<sup>ii</sup> Texas Department of Agriculture, "Rural Municipal Finance," accessed online at [http://www.agr.state.tx.us/agr/program\\_render/0,1987,1848\\_6058\\_0\\_0,00.html?channelld=6058](http://www.agr.state.tx.us/agr/program_render/0,1987,1848_6058_0_0,00.html?channelld=6058), April 2007.

# **Appendix A**

## **Population Projections**

## **APPENDIX A**

### **POPULATION PROJECTIONS**

#### **A.1 INTRODUCTION**

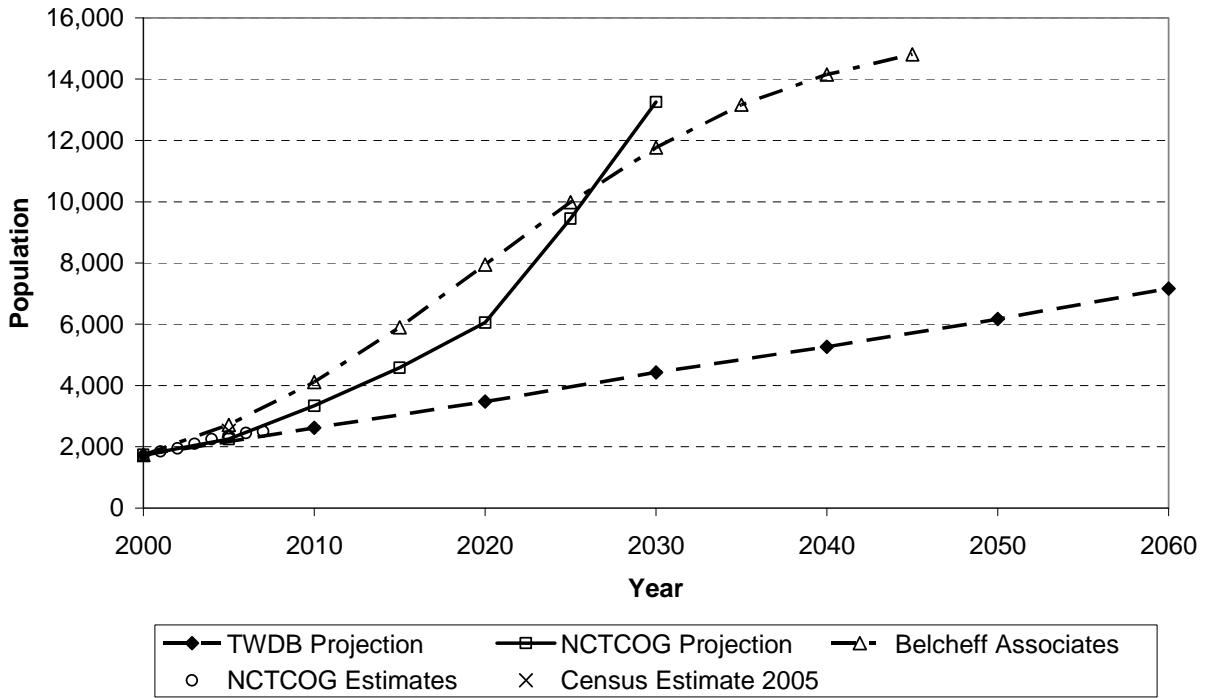
Historical and projected populations were obtained (where available) from the Participants, the Texas Water Development Board (TWDB), the North Central Texas Council of Governments (NCTCOG), and the U.S. Census Bureau. In consultation with the Participants, a single population projection was selected for use in developing the regional wastewater facilities plan.

For most cities, the selected population projection is the TWDB population projection or is derived from the TWDB population projection. There are three exceptions: Aledo, Willow Park, and Deer Creek Waterworks. The TWDB projections for Aledo and Willow Park show smaller growth rates than for cities to their east (Fort Worth in Parker County) and to their west (Hudson Oaks). Since Fort Worth is a primary economic driver for population growth in the Planning Region, it makes sense that population growth will move westward from Fort Worth and that Aledo and Willow Park will grow as rapidly as their neighbors. The selected population projection for Aledo is one that was developed by Belcheff Associates, Inc. This projection better corresponds to the 2005 U.S. Census Bureau population estimate than the other projections and is the projection that Aledo is using in its own planning work. For Willow Park, the selected population projection is the NCTCOG projection.

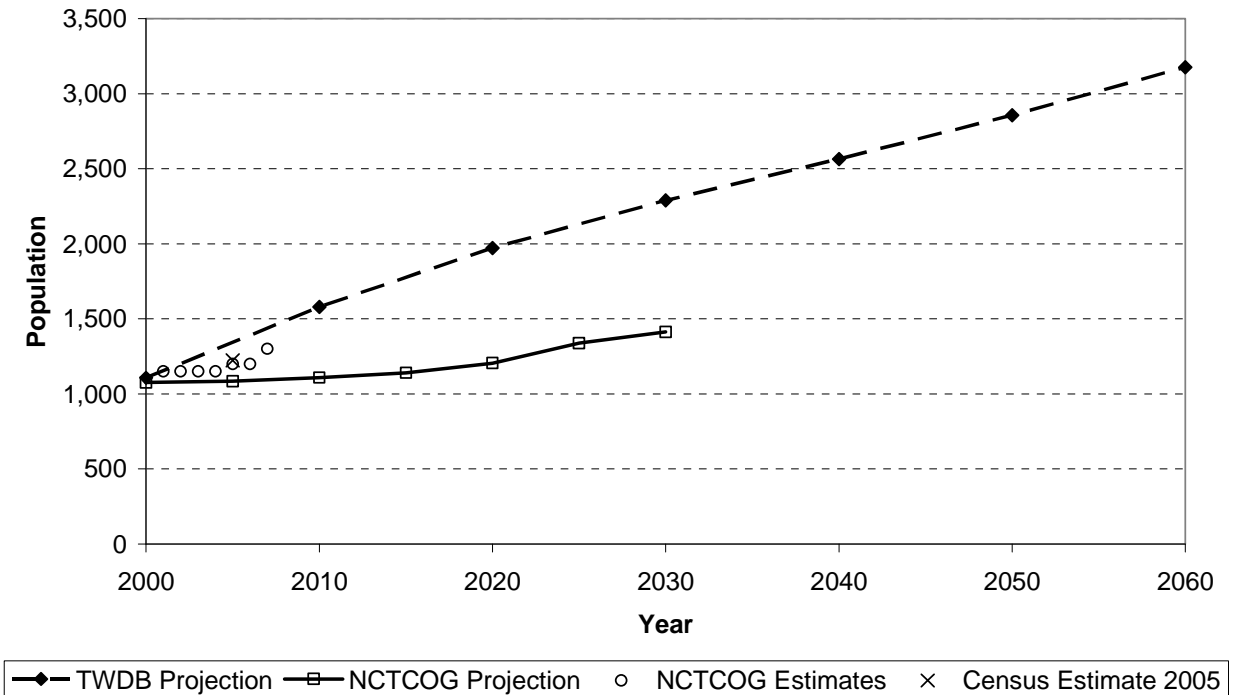
Population projections for the Deer Creek Waterworks CCN were not available. Part of this population is included in the projections for Annetta. The remainder of the population for the Deer Creek Waterworks CCN was estimated based on existing flows to the Deer Creek Waterworks WWTP and was assumed to grow at the average growth rate for Annetta and Annetta South during the planning period.

The population projections for each Participant are shown in the Figures A-1 through A-8.

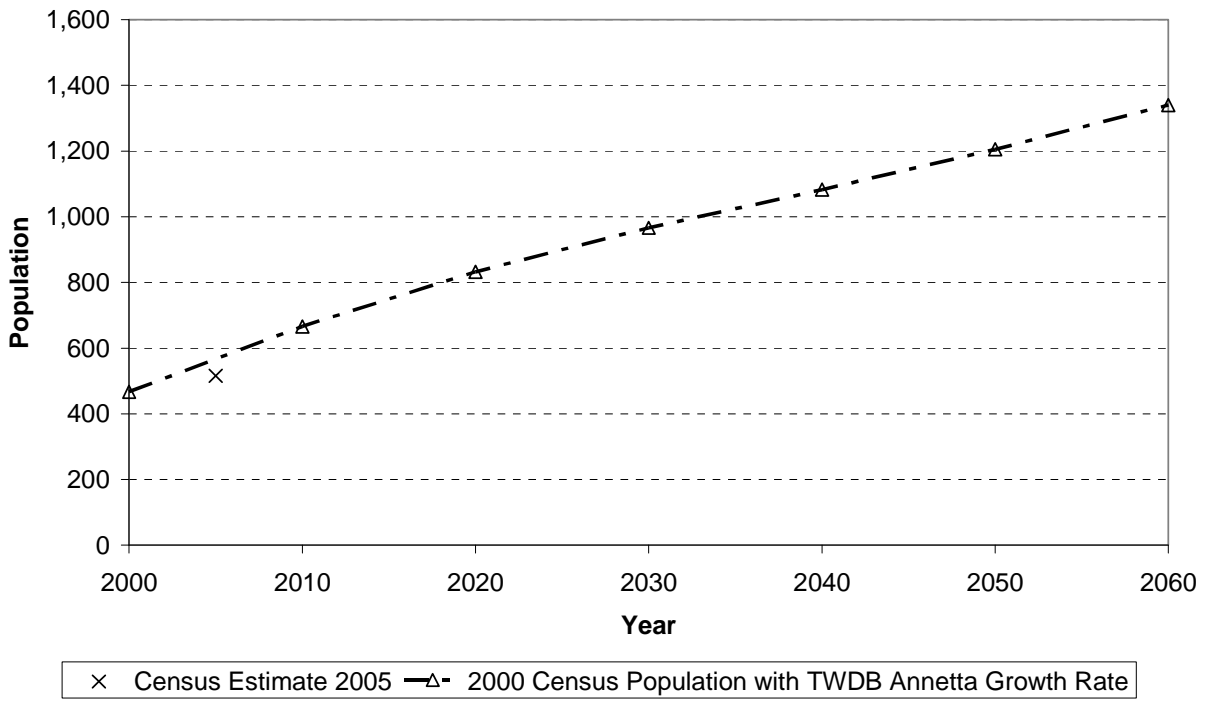
**Figure A-1  
Population Projections: Aledo**



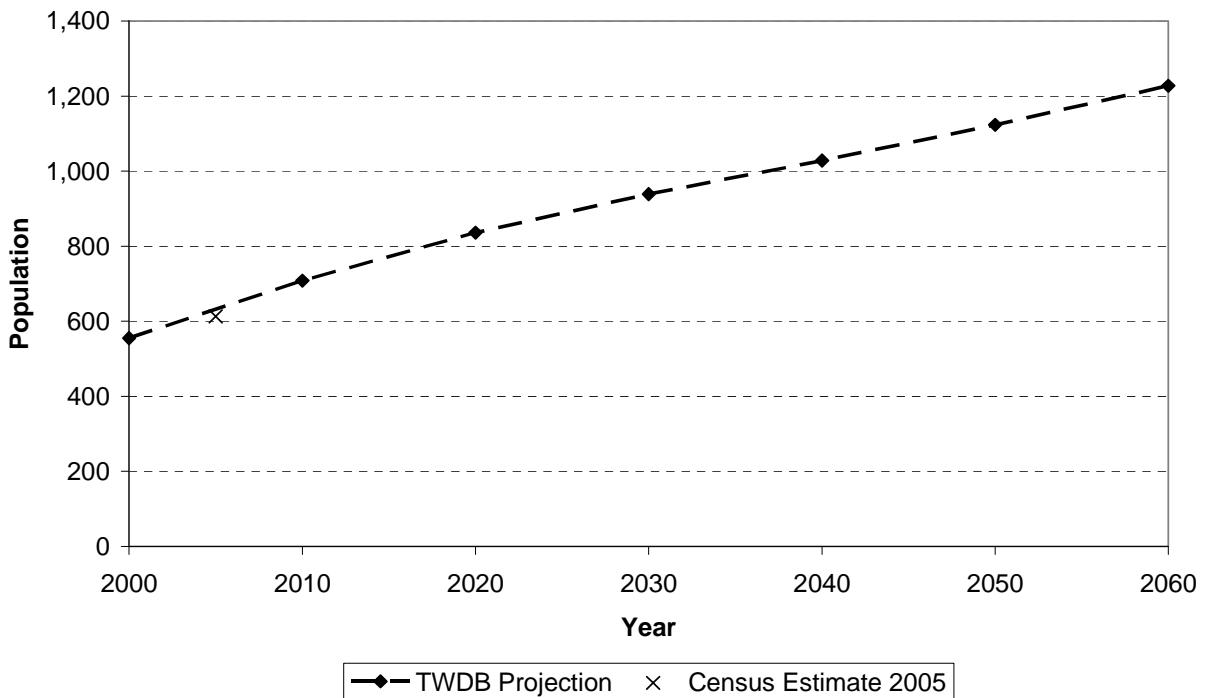
**Figure A-2  
Population Projections: Annetta**



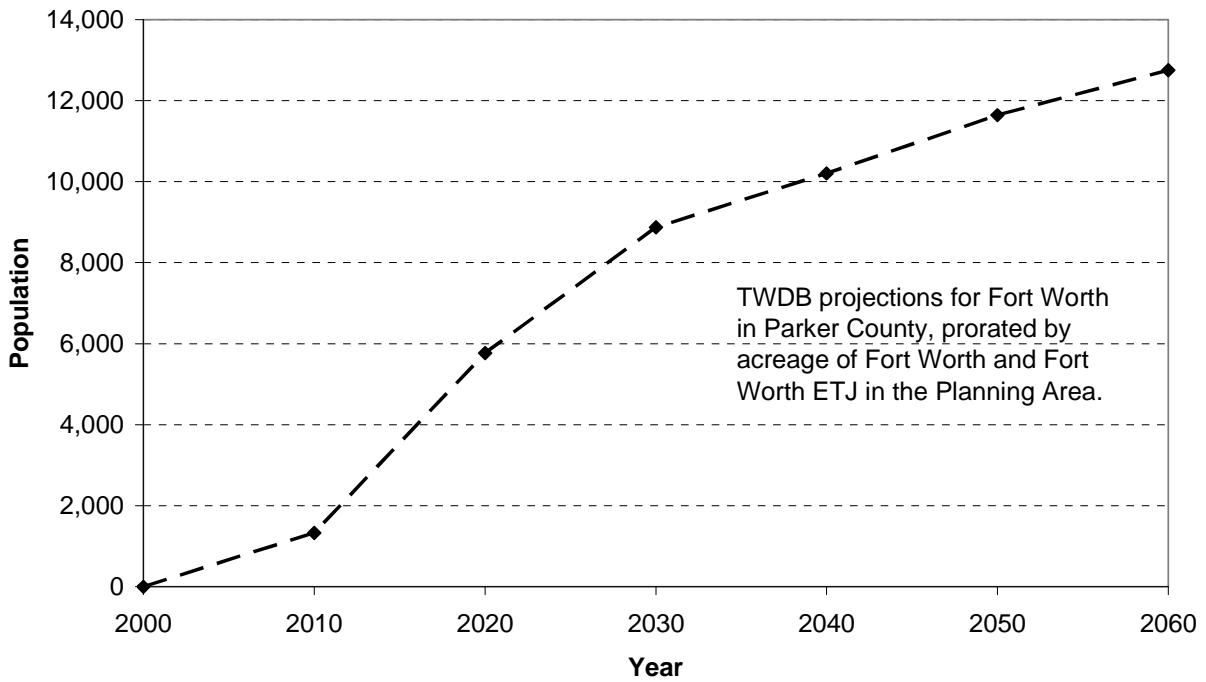
**Figure A-3  
Population Projections: Annetta North**



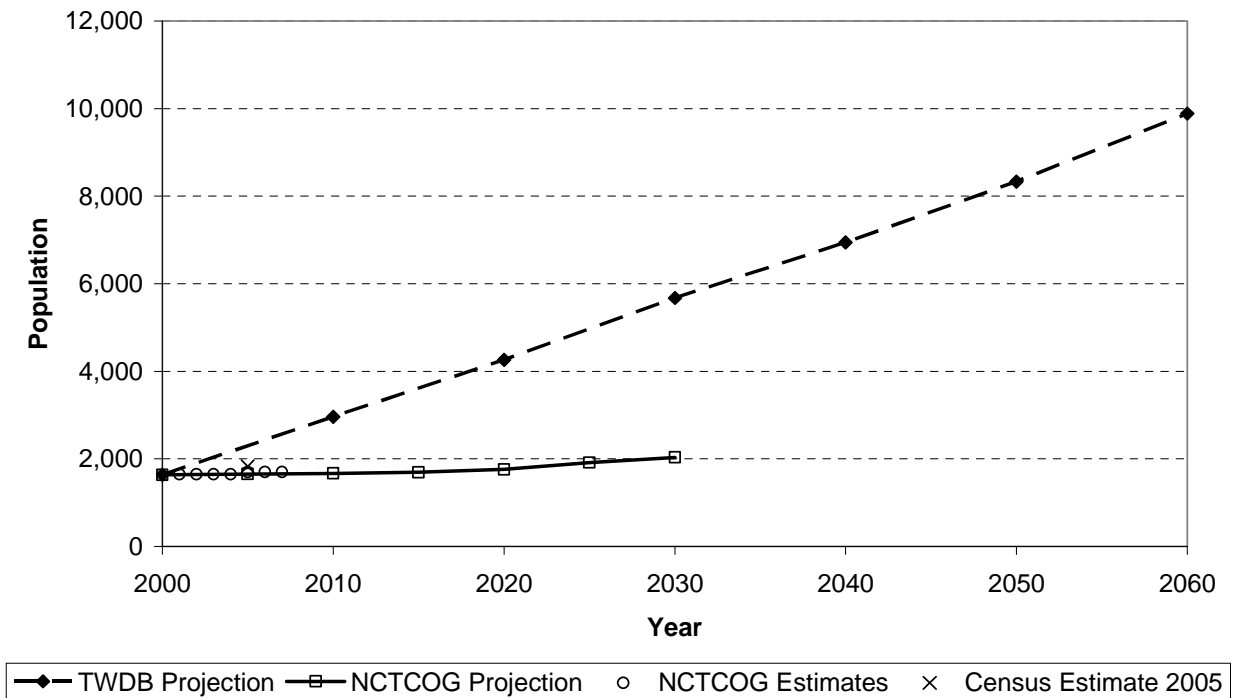
**Figure A-4  
Population Projections: Annetta South**



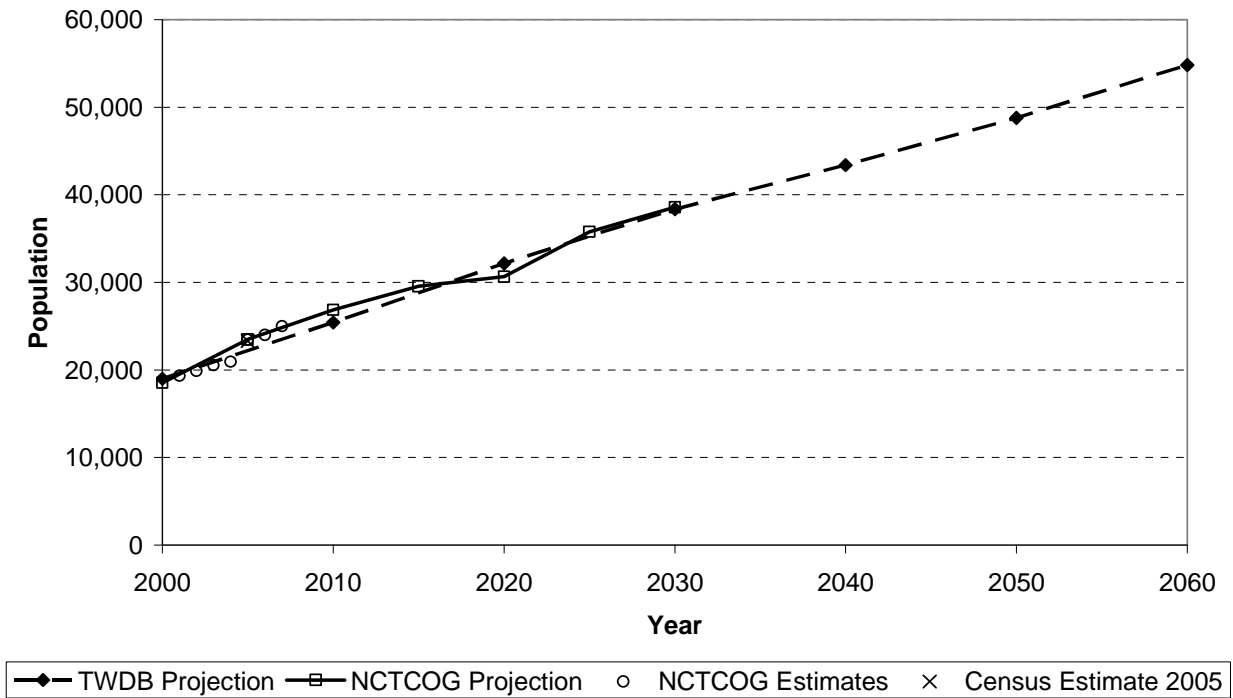
**Figure A-5  
Population Projections: Fort Worth (Planning Area)**



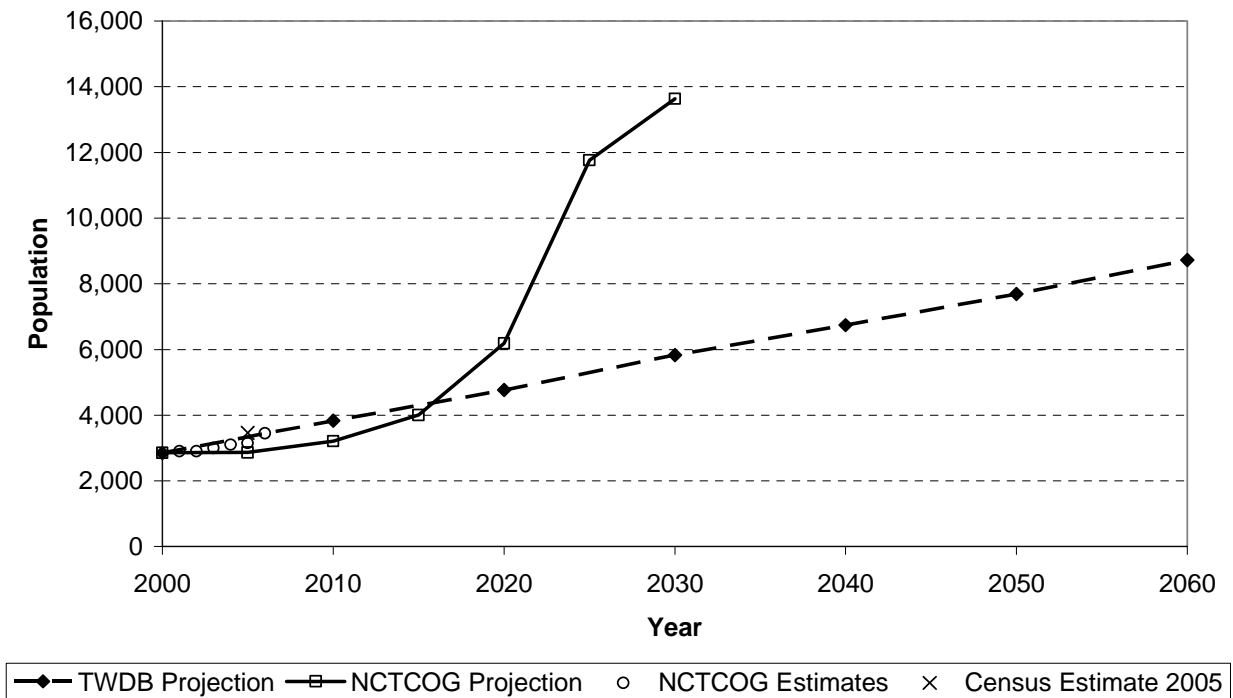
**Figure A-6  
Population Projections: Hudson Oaks**



**Figure A-7  
Population Projections: Weatherford**



**Figure A-8  
Population Projections: Willow Park**



# **Appendix B**

## **General Cost Guidelines**



## **APPENDIX B**

### **GENERAL COST GUIDELINES**

#### **B.1 INTRODUCTION**

Evaluation of a complex combination of wastewater transport and treatment alternatives requires development of opinions of probable cost. This appendix presents the general cost guidelines used in developing the opinions of probable cost that were used for screening different alternatives. Unless otherwise noted, all costs are presented in year 2007 dollars.

The opinions of probable cost have two components:

- Capital costs, including construction, engineering, and contingency costs, and
- Annual costs, including operation and maintenance costs and debt service.

#### **B.2 CAPITAL COST GUIDELINES**

Capital cost guidelines have been developed for a regional wastewater conveyance system and regional wastewater treatment plants in the form of construction cost tables. Construction costs include contractors' mobilization, overhead, and profit but do not include engineering, contingency, financial and legal services, costs for land and rights-of-way, permits, environmental and archeological studies, or mitigation.

##### **B.2.1 Regional Wastewater Conveyance Systems**

Gravity interceptor and force main construction costs are shown in Table B-1. Lift station construction costs were based on required flowrate capacity and are listed in Table B-2. Selection of gravity interceptor, force main, and lift station sizes is determined by peak flow transport requirements. Other assumptions used in the hydraulic analysis of gravity interceptors, force mains, and lift stations include:

- Peak flowrate is 4 times the annual average flowrate.
- Pipe slopes generally follow topographic slopes.
- Manning's roughness coefficient of 0.013 for analysis of gravity interceptors.
- Hydraulic grade line less than or equal to top of pipe for gravity interceptors.
- Hazen-Williams C factor of 120 for analysis of force mains.
- Maximum head loss of 5.5 feet per 1,000 feet of force main.
- Pump efficiency of 75 percent.

**Table B-1  
Gravity Interceptor and Force Main Unit Construction Costs**

Diameter (in)	Gravity Interceptor		Force Main	
	Construction Cost (\$/ft length)	Right of Way Width (ft)	Construction Cost (\$/ft length)	Right of Way Width (ft)
6	53	15	53	15
8	71	15	71	15
10	89	20	89	20
12	107	20	107	20
14			124	20
15	133	20		
16			142	20
18	160	20	160	20
20			181	20
21	171	20		
24	182	20	223	20
27	193	20	255	20
30	204	20	286	20
33	230	20	311	20
36	257	20	336	20
42	310	30	394	30
48	363	30	452	30
54	417	30	507	30
60	470	30	563	30

**Table B-2  
Lift Station Construction Costs**

<b>Flowrate (mgd)</b>	<b>Construction Cost</b>
0.5	\$220,884
1	\$404,957
2	\$524,623
3	\$644,249
4	\$1,190,601
5	\$1,736,953
6	\$2,283,305
12	\$3,635,767
20	\$4,179,607
30	\$4,859,407

**B.2.2 Regional Wastewater Treatment Plants**

Screening-level construction costs for a new regional wastewater treatment plant (WWTP) or an expansion of an existing WWTP are shown in Table B-3. Sizing of WWTPs is determined by average annual flow treatment requirements. The screening-level construction cost for retrofit of facilities at existing WWTPs to meet more stringent effluent quality limits was assumed to be \$1.00 per gallon per day of capacity.

**Table B-3  
Wastewater Treatment Plant Construction Costs**

<b>Flowrate (mgd)</b>	<b>Construction Cost</b>
1	\$8,000,000
3	\$15,000,000
5	\$25,000,000
7	\$28,000,000
10	\$40,000,000
15	\$60,000,000

Once the recommended wastewater treatment alternative was identified, the opinion of probable cost was refined to account for the recommended facilities (Chapter 9).

### **B.2.3 Other Costs**

Engineering, contingency, construction management, financial, and legal costs were assumed to equal 30 percent of the construction cost for gravity interceptors and force mains and 35 percent of the construction cost for lift stations and WWTPs.

Permitting; environmental and archaeological studies; and mitigation for gravity interceptors, force mains, lift stations, and WWTP sites were assumed to be 1 percent of the total construction costs, including a 20 percent allowance for construction contingencies but not including engineering, construction management, financial and legal costs. For WWTPs, there will be permitting costs as well; these costs are highly variable and were not estimated.

Right-of-way costs for gravity interceptors and force mains and site costs for lift stations and WWTPs were assumed to be \$20,000 per acre. It was assumed that one acre is needed for a lift station and that 20 acres are needed for a new WWTP. For expansion of an existing WWTP, it was assumed that sufficient land is already available on-site.

Interest during construction is the total of interest accrued at the end of the construction period with the following assumptions:

- 6 percent annual interest rate on total borrowed funds
- 4 percent rate of return on investment of unspent funds
- Total project cost (excluding interest during construction) drawn down at a constant rate per month during the construction period.

The interest during construction depends on the length of the construction period and was assumed to be a percentage of the capital cost subtotal. The interest during construction for different construction periods is shown in Table B-4.

**Table B-4  
Interest During Construction**

<b>Construction Period (months)</b>	<b>Percentage of Capital Cost Subtotal</b>
6	2.17%
12	4.17%
18	5.76%
24	7.82%
36	11.88%

### **B.3 ANNUAL COST GUIDELINES**

Annual costs include debt service on capital improvements; operation and maintenance of interceptors, force mains, and pump stations; pumping costs; and operation and maintenance of WWTPs. Each is discussed below.

#### **B.3.1 Debt Service**

For “standard financing” discussed in Chapter 9, debt service for capital costs was annualized over 20 years at an interest rate of 4.5 percent per year.<sup>ee</sup> For State Participation Program financing, debt service for capital costs was annualized over 35 years at an interest rate of 5.75 percent per year.<sup>ff</sup>

#### **B.3.2 Operation and Maintenance**

Operation and maintenance (O&M) costs were based on the construction cost of the capital improvement, including a 20 percent allowance for construction contingencies but not including engineering, construction management, financial, and legal costs. O&M costs are calculated at 1 percent of the construction costs for gravity interceptors and force mains and 2.5 percent of the construction costs for lift stations. O&M costs for WWTPs are included in the treatment cost.

#### **B.3.3 Pumping**

Pumping costs are based on an electricity rate of \$0.12 per kilowatt-hour.

### **B.3.4 Wastewater Treatment**

Treatment costs<sup>40</sup> were obtained for each existing treatment plant in the planning area and divided into maintenance costs and fixed and variable operations costs. Fixed costs do not depend on the flowrate to the WWTP, but instead depend on the capacity of the WWTP. Variable costs depend on the wastewater flowrate. Table B-5 shows estimated maintenance costs and fixed and variable operations costs for existing WWTPs in the Planning Area for the 2005-2006 fiscal year.

**Table B-5: Treatment Costs at Existing WWTPs**

<b>Item</b>	<b>Units</b>	<b>Aledo</b>	<b>Deer Creek</b>	<b>Weatherford</b>	<b>Willow Park</b>
Fixed Operations Costs	\$	\$294,506	\$64,828	\$503,107	\$94,707
Maintenance Costs	\$	\$11,520	\$20,000	\$78,600	\$31,880
Variable Operations Costs	\$	\$88,800	\$16,000	\$322,000	\$30,500
Annual Average Flowrate	mgd	0.236	0.084 <sup>41</sup>	2.117	0.062
Treatment Capacity	mgd	0.35	0.1056	4.5	0.30
Variable Operations Costs	\$/kgal	\$1.03	\$0.52	\$0.42	\$1.35

The annual wastewater treatment costs at existing WWTPs were assumed to consist of the following components:

- Fixed operations cost for the WWTP,
- The product of the variable operations cost for the WWTP (dollars per thousand gallons treated) and the projected annual average plant flowrate, and
- Maintenance cost for the WWTP.

The sum of these components represents the full cost of operating the WWTP.

Annual wastewater treatment costs at a new, regional WWTP were based on the same

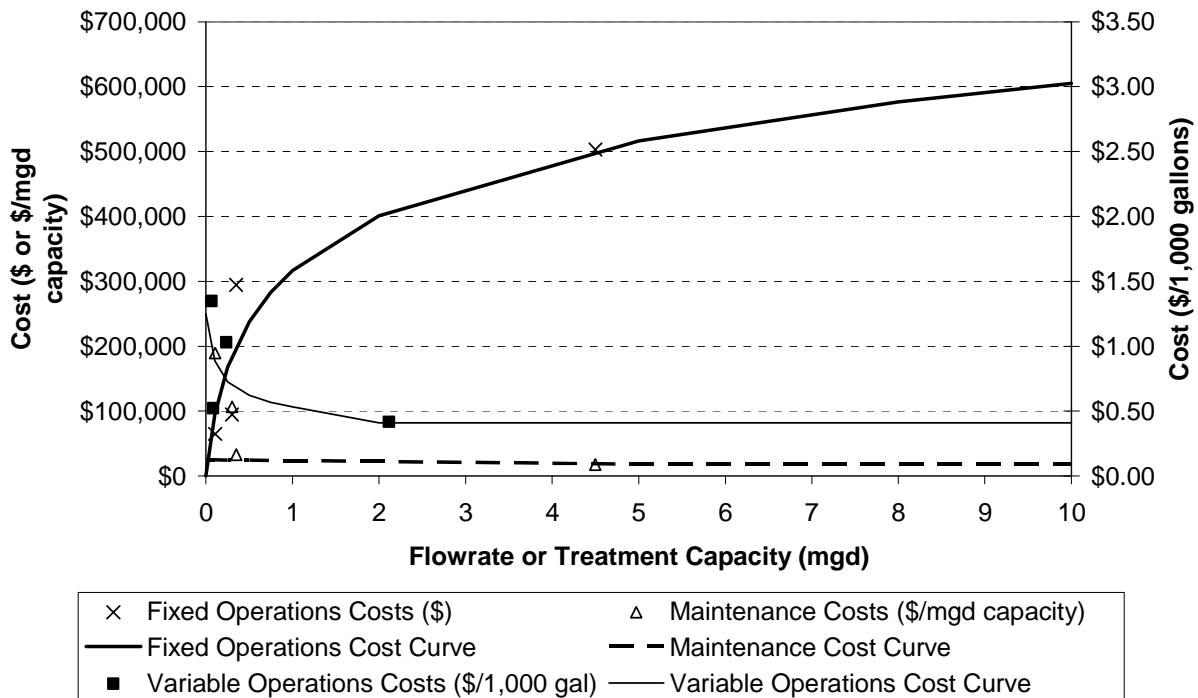
---

<sup>40</sup> Existing debt service was not considered in cost comparisons because it must be paid regardless of the wastewater conveyance and treatment scenario.

<sup>41</sup> Assumes that recent flows are characteristic of actual flows from October 2005 through September 2006. In October 2006, it was discovered that the master meter was out of calibration, and a new master meter was installed. Since that time, reported flows have been a factor of about 5.6 times greater than those previously reported. The average flowrate since the new master meter was installed (October 2006 through April 2007) is 0.084 mgd.

components, except that the fixed operations cost, the variable operations cost, and the maintenance cost were interpolated from the cost curves in Figure B-1. These cost curves were derived from the fixed operations costs, the variable operations costs, and the maintenance costs at the existing WWTPs.

**Figure B-1**  
**Cost Curves Derived From O&M Costs at Existing WWTPs**



# **Appendix C**

## **Regional Collection System Details**



## **APPENDIX C**

### **REGIONAL COLLECTION SYSTEM DETAILS**

#### **C.1 INTRODUCTION**

As shown in Figure 5-6, the regional collection system would be constructed in three phases: Phase 1 by 2012, Phase 2 by 2016, and Phase 3 by 2021. A fourth phase consisting of lift station improvements would be necessary by 2030. This appendix presents the conceptual design for the regional collection system by facilities, size, and opinion of probable construction cost.

#### **C.2 INTERCEPTORS AND FORCE MAINS**

Interceptor and force main details are shown in Table C-1. Several Phase 1 interceptors and force mains (B-A, C-B, D-C, E-D, and Y-X in Figure 5-6) will be paralleled in Phase 3. Although the total capital cost for these interceptors will be greater than if a larger interceptor were constructed in Phase 1, the benefits include lower initial capital costs and interceptors that are more properly sized for the projected Phase 1 flows. In other cases (e.g., F-E), a parallel pipe would be necessary within five years, so a larger interceptor was recommended for initial construction.

For each interceptor segment, the interceptor slope has been assumed to be the average topographic slope. During the preliminary design phase, interceptor diameters and slopes should be revised as necessary to limit the depth of the interceptors. Additional lift stations and force mains may be necessary to limit interceptor depth. Force mains are assumed to be located at a depth of approximately five feet.

**Table C-1  
Interceptor and Force Main Details**

Phase	Segment Name	Type	Length (ft)	Diameter (in)	Right-of-Way Width (ft)	Projected Construction Cost	
						Interceptor	Right-of-Way
1	B-A	Gravity	12,303	24	40	\$2,235,577	\$225,950
1	C-B	Gravity	3,445	24	50	\$625,962	\$79,083
1	D-C	Gravity	2,953	24	50	\$536,539	\$67,785
1	E-D	Gravity	3,199	18	40	\$510,796	\$58,747
1	X-A	Gravity	11,811	15	40	\$1,571,679	\$216,912
1	Y-X	Force Main	5,495	10	40	\$487,782	\$100,925
1	AA-Z	Force Main	4,019	6	15	\$214,042	\$27,679
<b>Phase 1 Subtotal</b>			<b>43,225</b>			<b>\$6,182,376</b>	<b>\$777,081</b>
2	F-E	Gravity	4,019	33	20	\$925,770	\$36,905
2	G-F	Gravity	3,609	42	30	\$1,119,445	\$49,709
2	T-G	Gravity	5,495	18	20	\$877,521	\$50,462
2	U-T	Gravity	1,804	12	20	\$192,201	\$16,570
2	V-U	Gravity	10,170	6	15	\$541,657	\$70,045
2	W-F	Gravity	2,625	6	15	\$139,782	\$18,076
<b>Phase 2 Subtotal</b>			<b>27,723</b>			<b>\$3,796,375</b>	<b>\$241,767</b>
3	B-A	Gravity	12,303	36	NA	\$3,161,423	\$0
3	C-B	Gravity	3,445	42	NA	\$1,068,561	\$0
3	D-C	Gravity	2,953	42	NA	\$915,909	\$0
3	E-D	Gravity	3,199	36	NA	\$821,970	\$0
3	H-G	Gravity	5,003	36	20	\$1,285,645	\$45,943
3	I-H	Gravity	9,104	33	20	\$2,097,152	\$83,602
3	J-I	Gravity	2,871	30	20	\$584,863	\$26,361
3	K-J	Gravity	7,546	21	20	\$1,288,054	\$69,291
3	L-K	Gravity	9,268	8	15	\$658,142	\$63,831
3	M-L	Gravity	5,249	10	20	\$465,941	\$48,203
3	N-K	Gravity	6,152	8	15	\$436,820	\$42,366
3	O-K	Gravity	3,937	6	15	\$209,673	\$27,114
3	P-I	Force Main	7,792	14	20	\$968,284	\$71,551
3	Q-P	Gravity	4,183	15	20	\$556,636	\$38,412
3	R-Q	Gravity	1,968	12	20	\$209,673	\$18,076
3	S-I	Gravity	1,968	10	20	\$174,728	\$18,076
3	Y-X	Force Main	5,495	10	NA	\$487,782	\$0
3	AC-AB	Gravity	5,987	6	15	\$318,878	\$41,236
<b>Phase 3 Subtotal</b>			<b>98,424</b>			<b>\$15,710,135</b>	<b>\$594,061</b>

Figures C-1 through C-26 show projected interceptor flows and capacities.

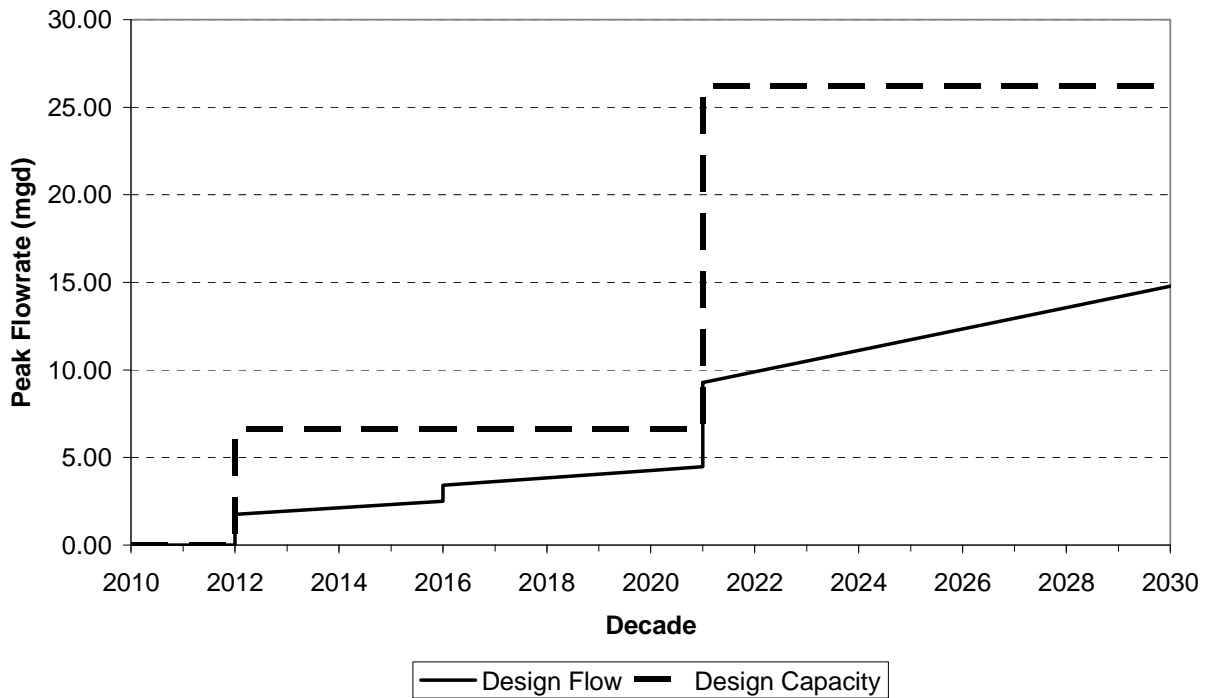
### C.3 LIFT STATIONS

Three lift stations are included in the conceptual design to convey flow from Fort Worth (Y in Figure 5-6) and portions of Hudson Oaks and Annetta North (P) to the Clear Fork WWTP and to convey flow from a portion of Annetta North (AA) to the Weatherford collection system. Lift station details are shown in Table C-2. The lift stations would be expanded in successive phases.

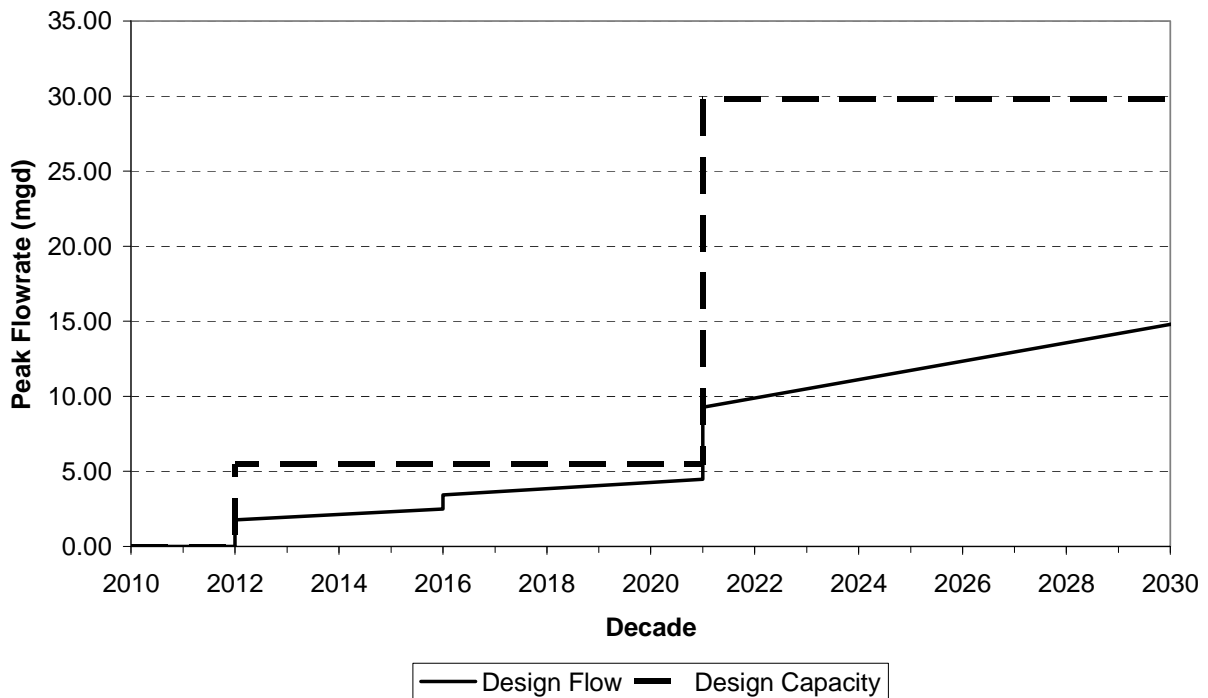
**Table C-2  
Lift Station Details**

Phase	Lift Station Name	Projected Total Capacity (mgd)	Projected Construction Costs	
			Lift Station	Lift Station Site
1	Y	0.77	\$318,533	\$20,000
1	AA	0.01	\$6,301	\$20,000
<b>Phase 1 Subtotal</b>			<b>\$324,834</b>	<b>\$40,000</b>
2	Y	1.16	\$176,517	\$0
2	AA	0.02	\$657	\$0
<b>Phase 2 Subtotal</b>			<b>\$177,173</b>	<b>\$0</b>
3	P	1.87	\$461,368	\$20,000
3	Y	1.70	\$233,960	\$0
3	AA	0.02	\$993	\$0
<b>Phase 3 Subtotal</b>			<b>\$696,320</b>	<b>\$20,000</b>
4	P	2.27	\$177,103	\$0
4	Y	1.96	\$112,715	\$0
4	AA	0.02	\$955	\$0
<b>Phase 4 Subtotal</b>			<b>\$290,773</b>	<b>\$0</b>

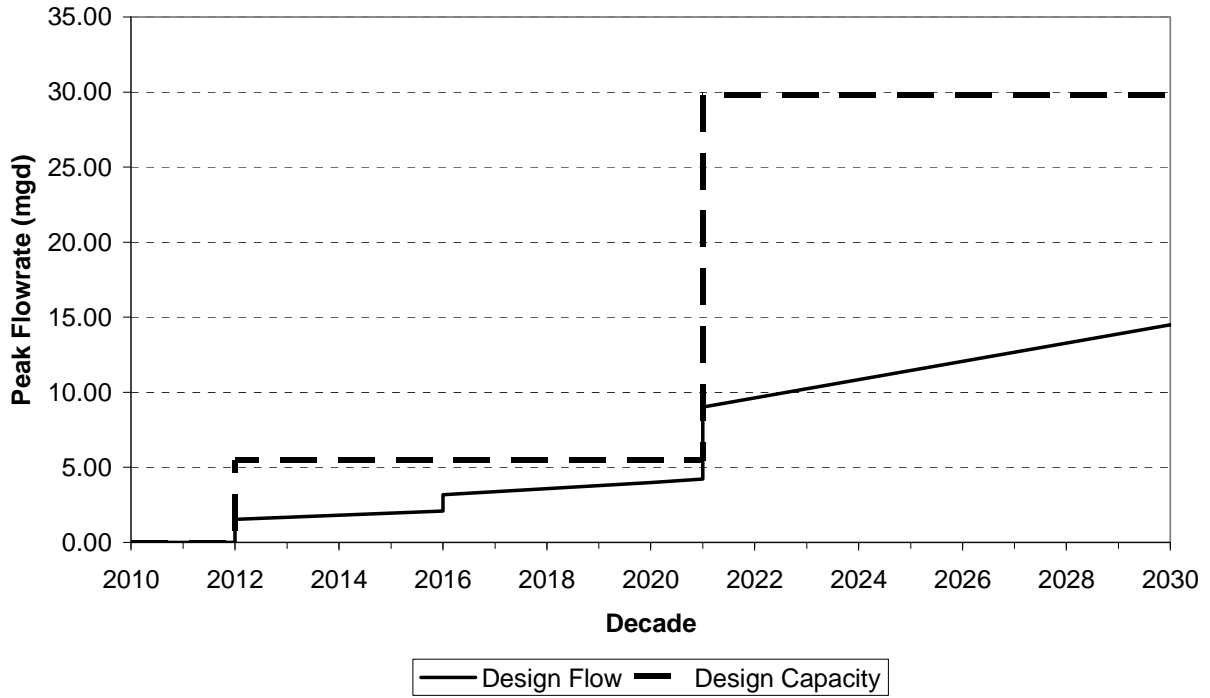
**Figure C-1  
Projected Interceptor Flow and Capacity: Segment B-A**



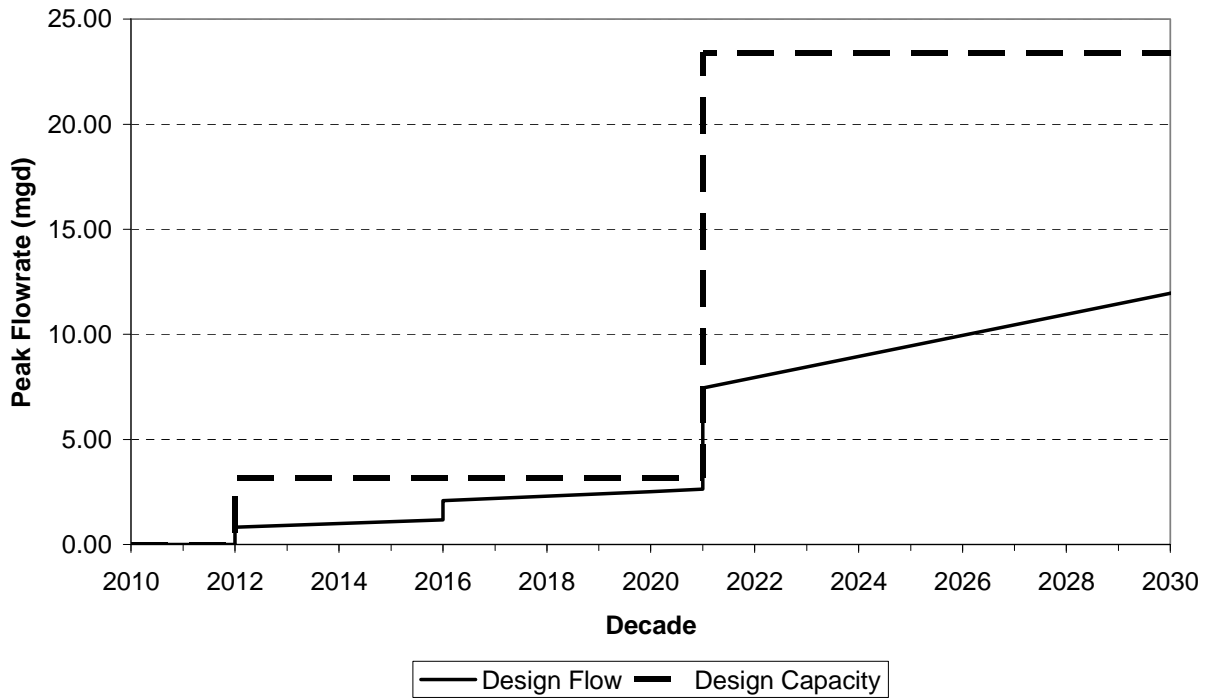
**Figure C-2  
Projected Interceptor Flow and Capacity: Segment C-B**



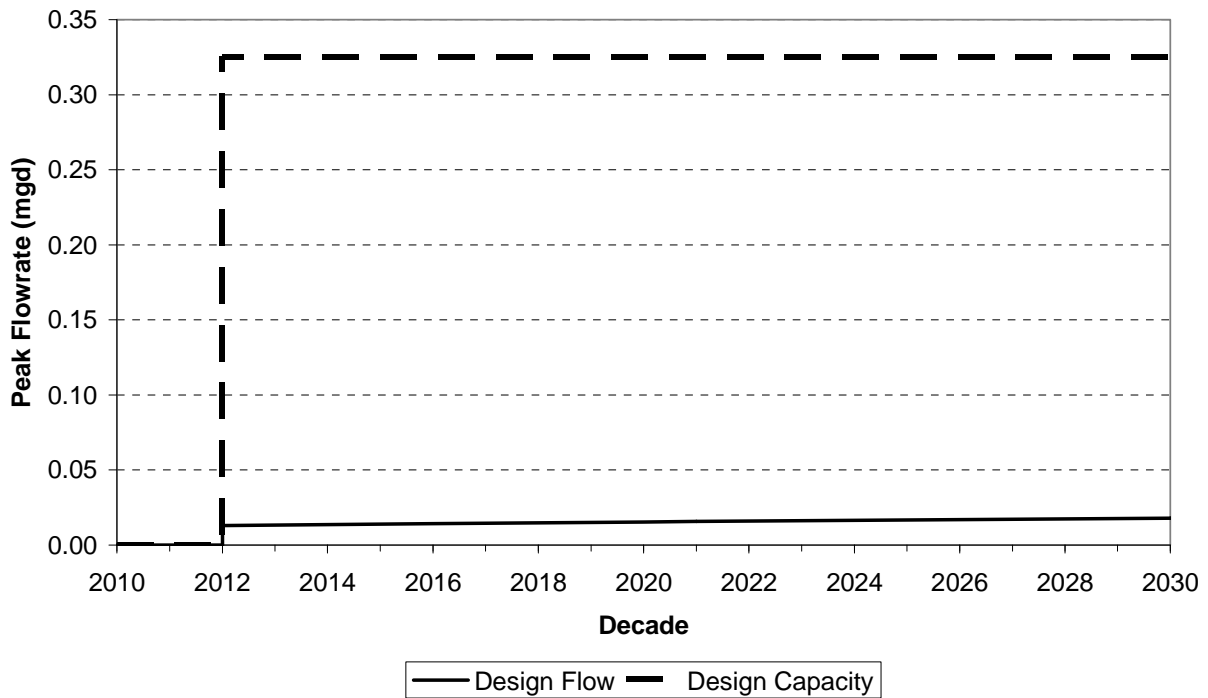
**Figure C-3  
Projected Interceptor Flow and Capacity: Segment D-C**



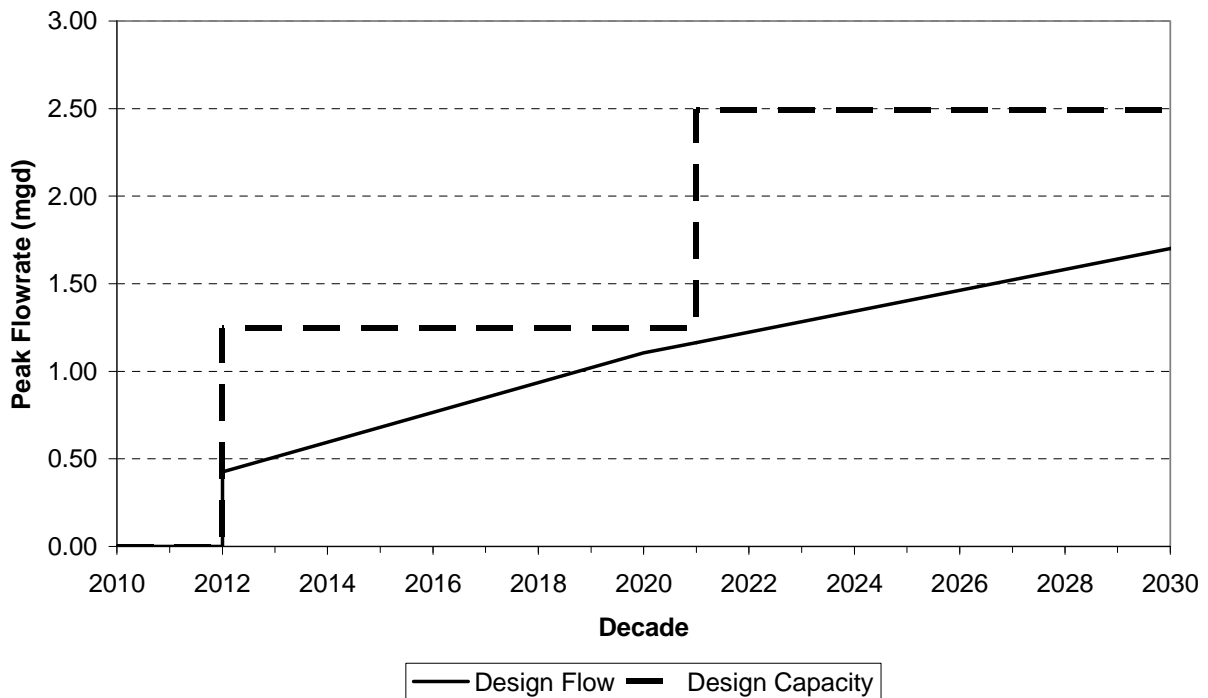
**Figure C-4  
Projected Interceptor Flow and Capacity: Segment E-D**



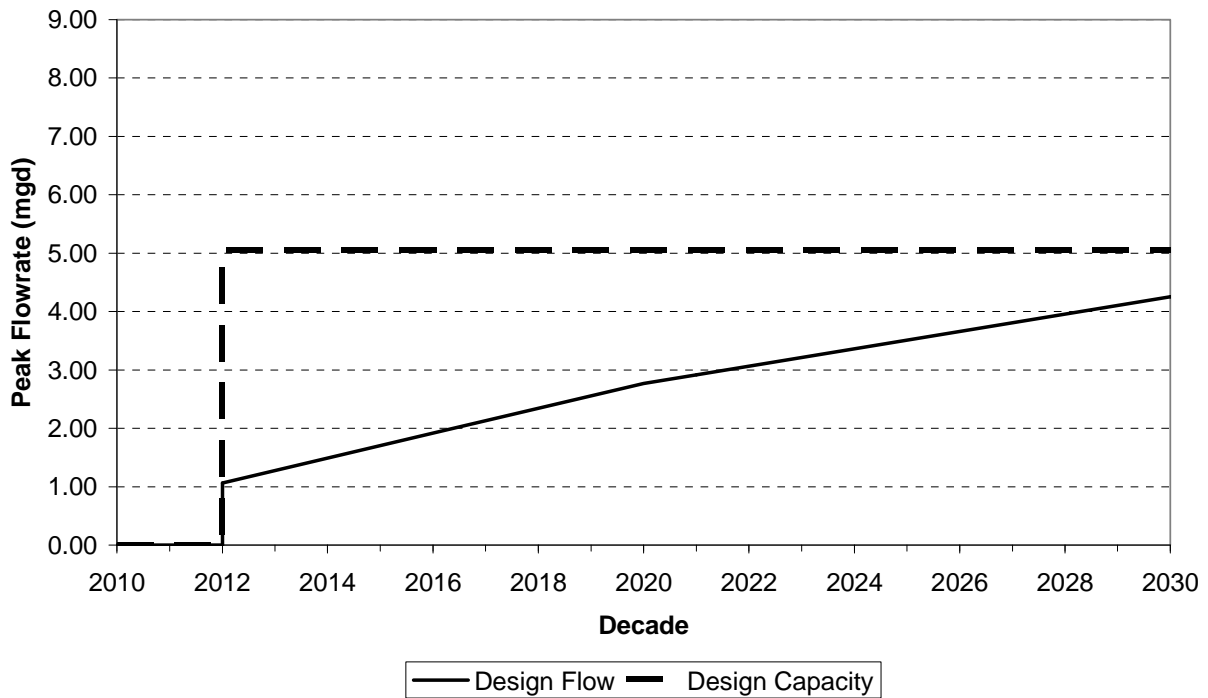
**Figure C-5**  
**Projected Interceptor Flow and Capacity: Segment Y-Z**



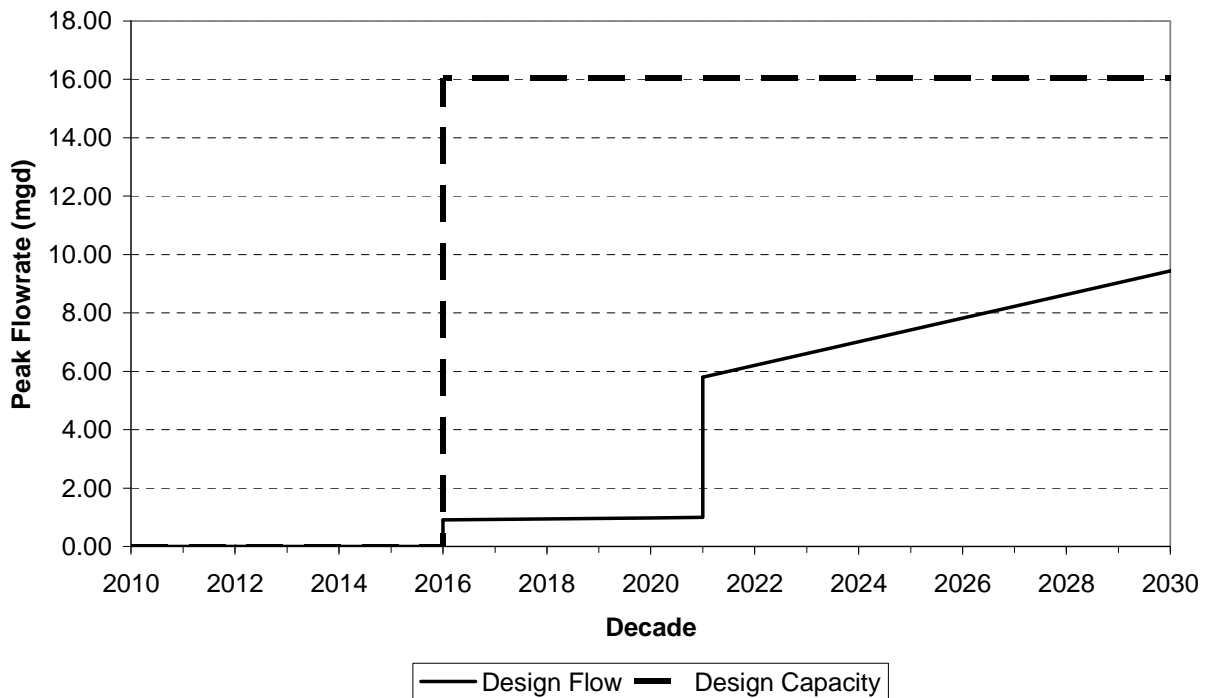
**Figure C-6**  
**Projected Interceptor Flow and Capacity: Segment Y-X**



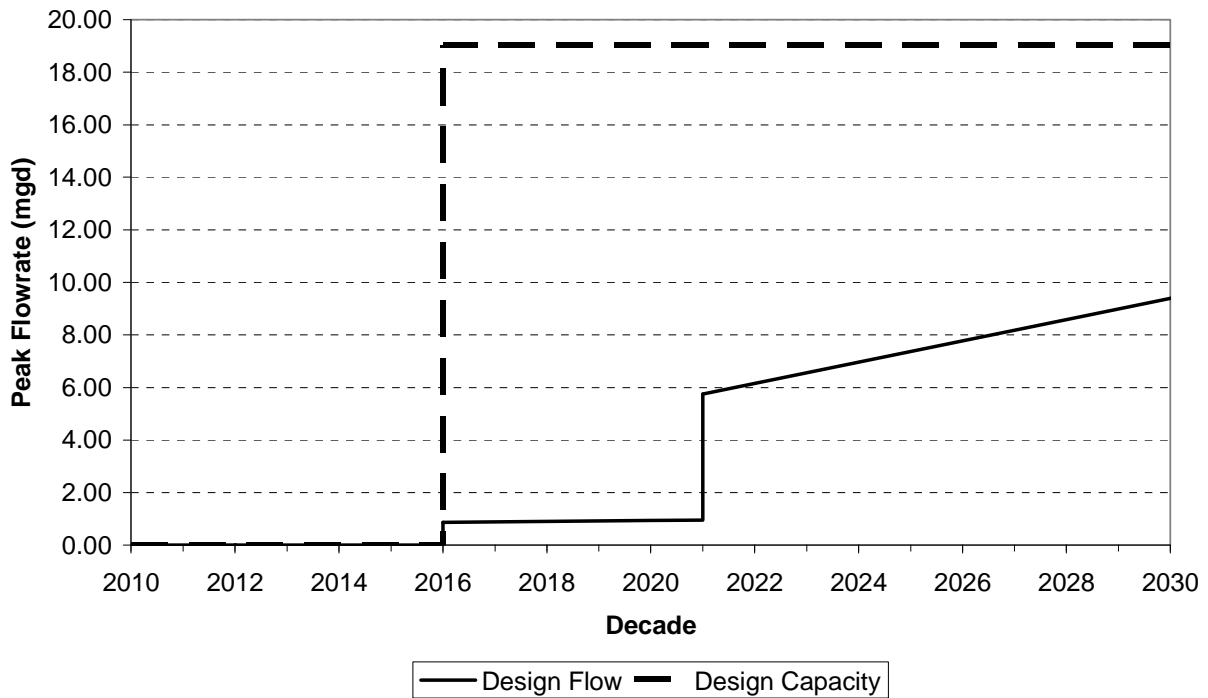
**Figure C-7  
Projected Interceptor Flow and Capacity: Segment X-A**



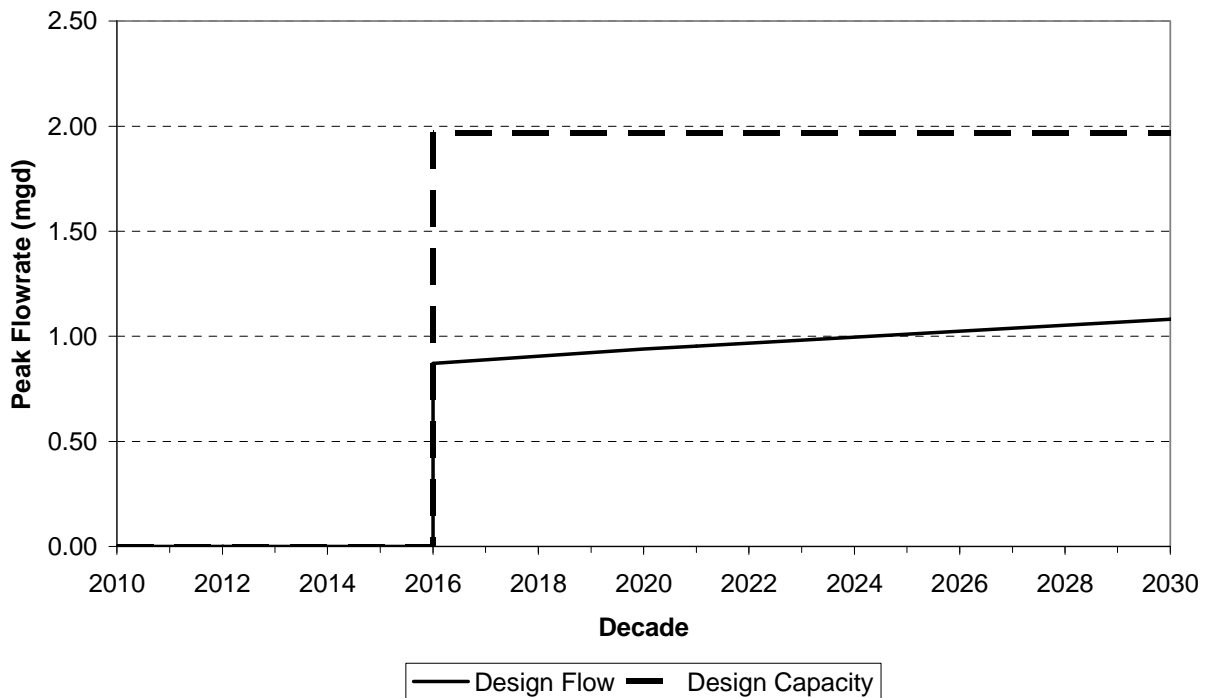
**Figure C-8  
Projected Interceptor Flow and Capacity: Segment F-E**



**Figure C-9**  
**Projected Interceptor Flow and Capacity: Segment G-F**

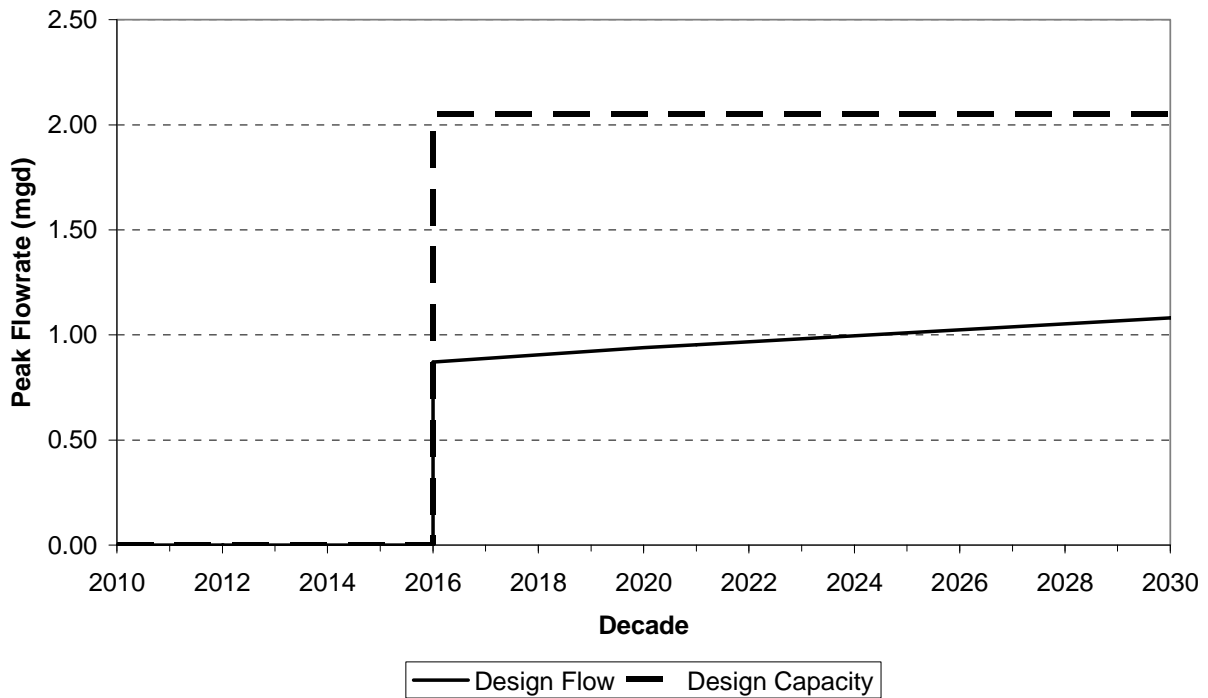


**Figure C-10**  
**Projected Interceptor Flow and Capacity: Segment T-G**

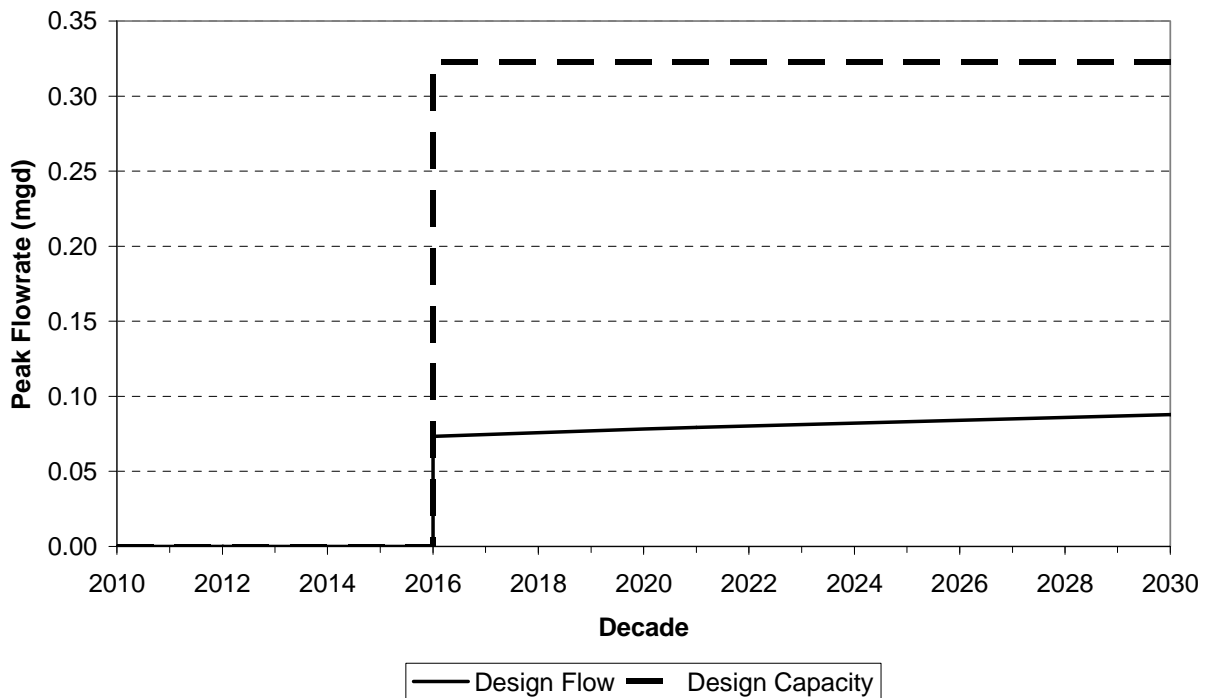




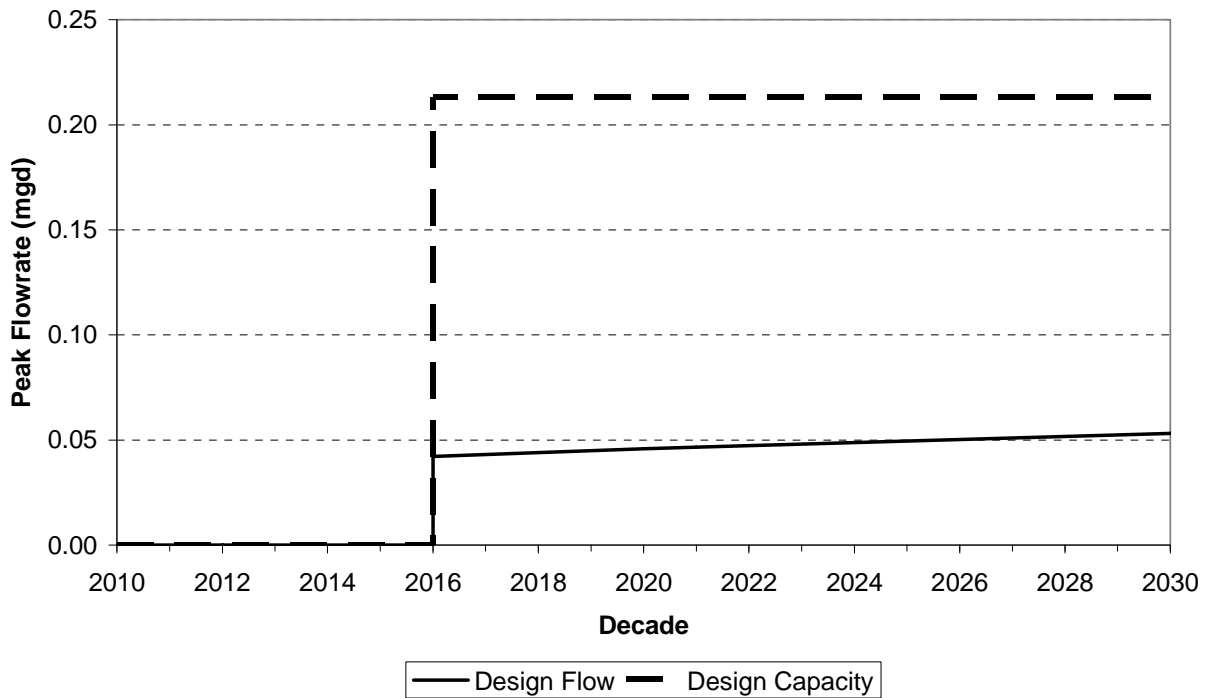
**Figure C-11**  
**Projected Interceptor Flow and Capacity: Segment U-T**



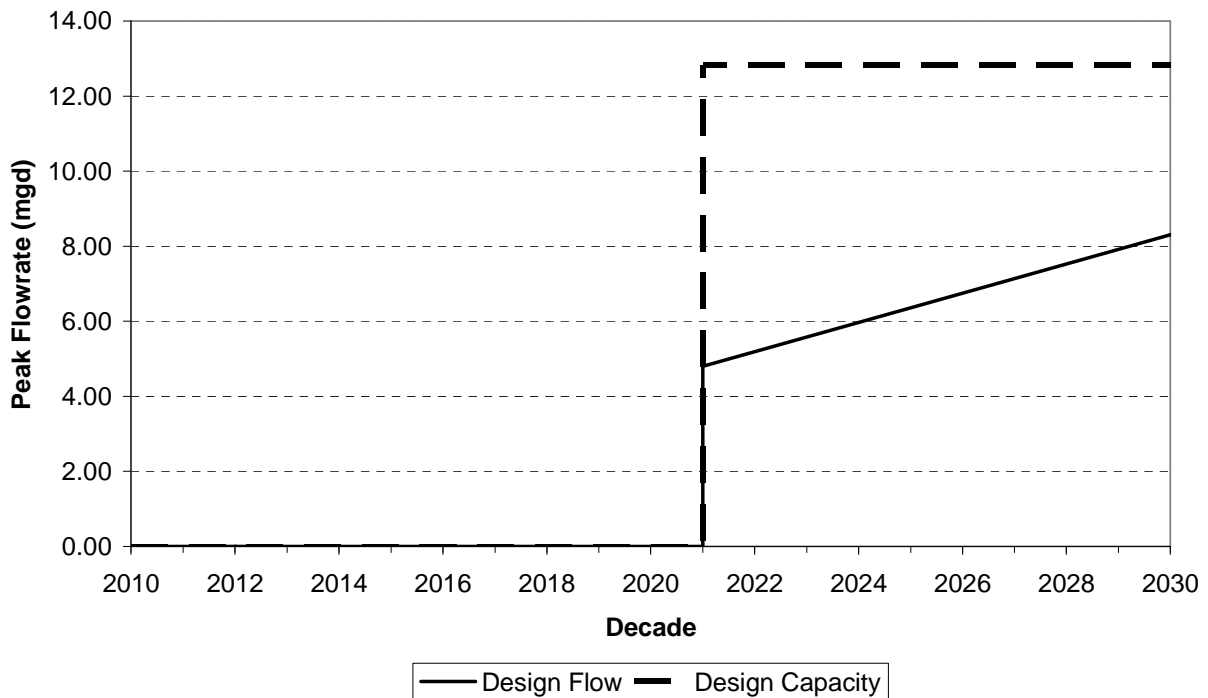
**Figure C-12**  
**Projected Interceptor Flow and Capacity: Segment V-U**



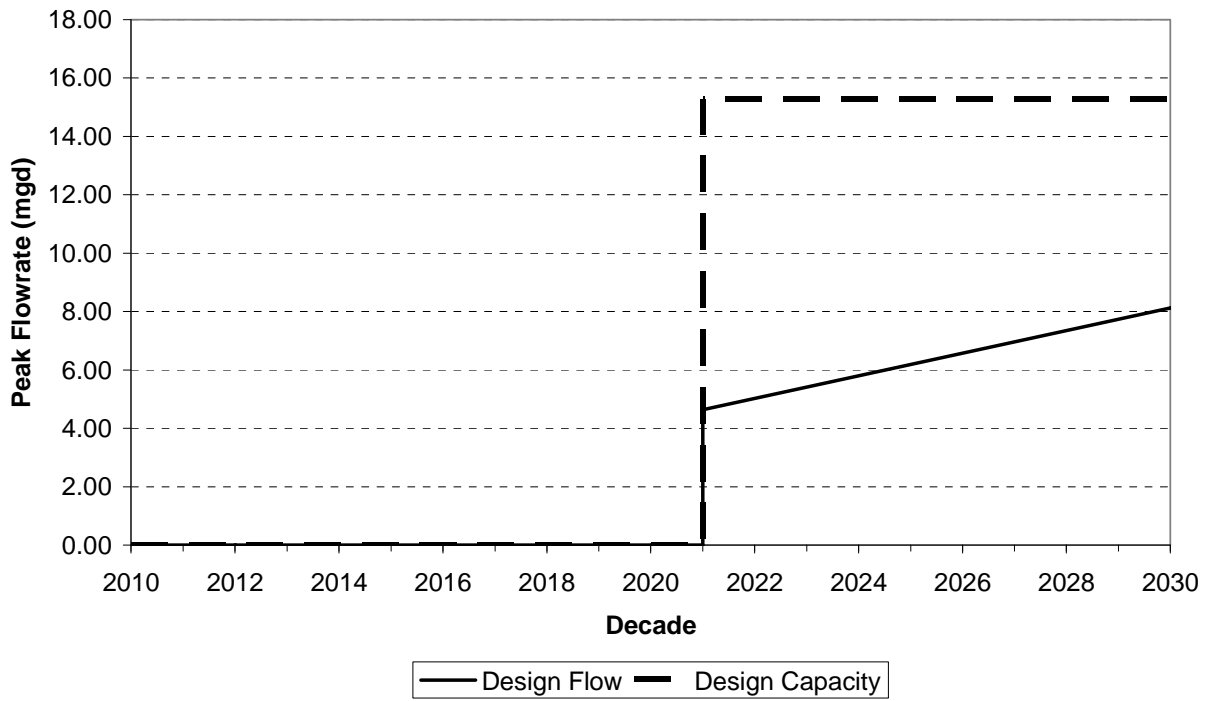
**Figure C-13**  
**Projected Interceptor Flow and Capacity: Segment W-F**



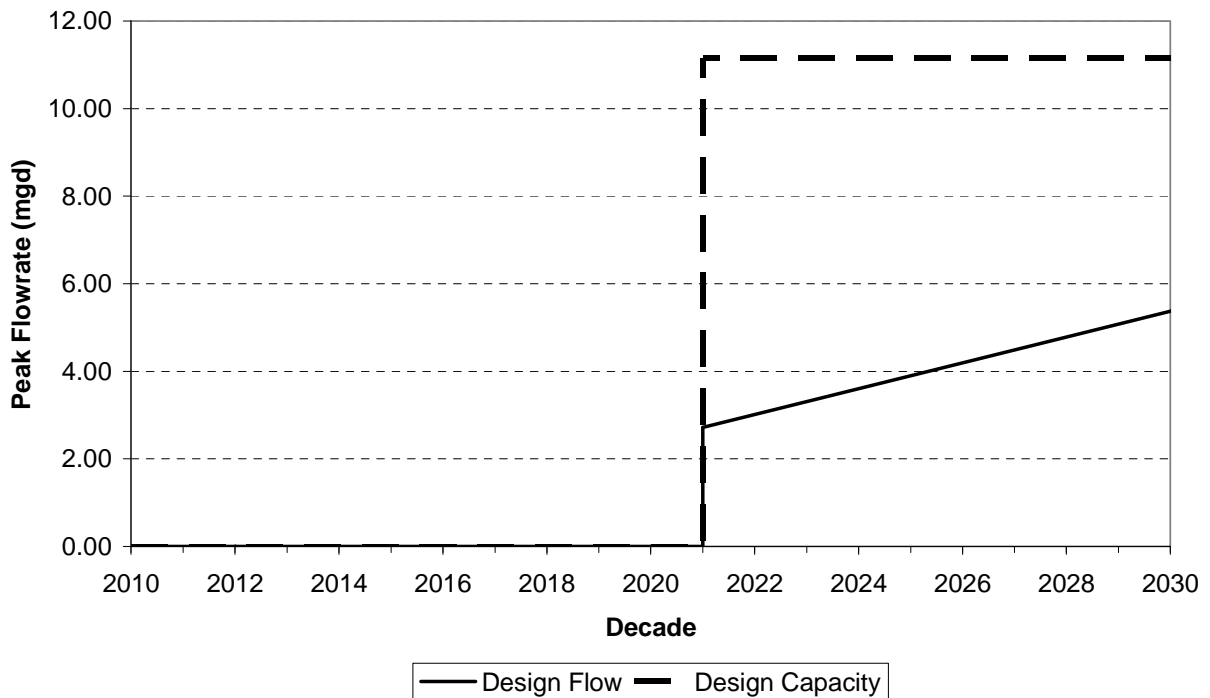
**Figure C-14**  
**Projected Interceptor Flow and Capacity: Segment H-G**



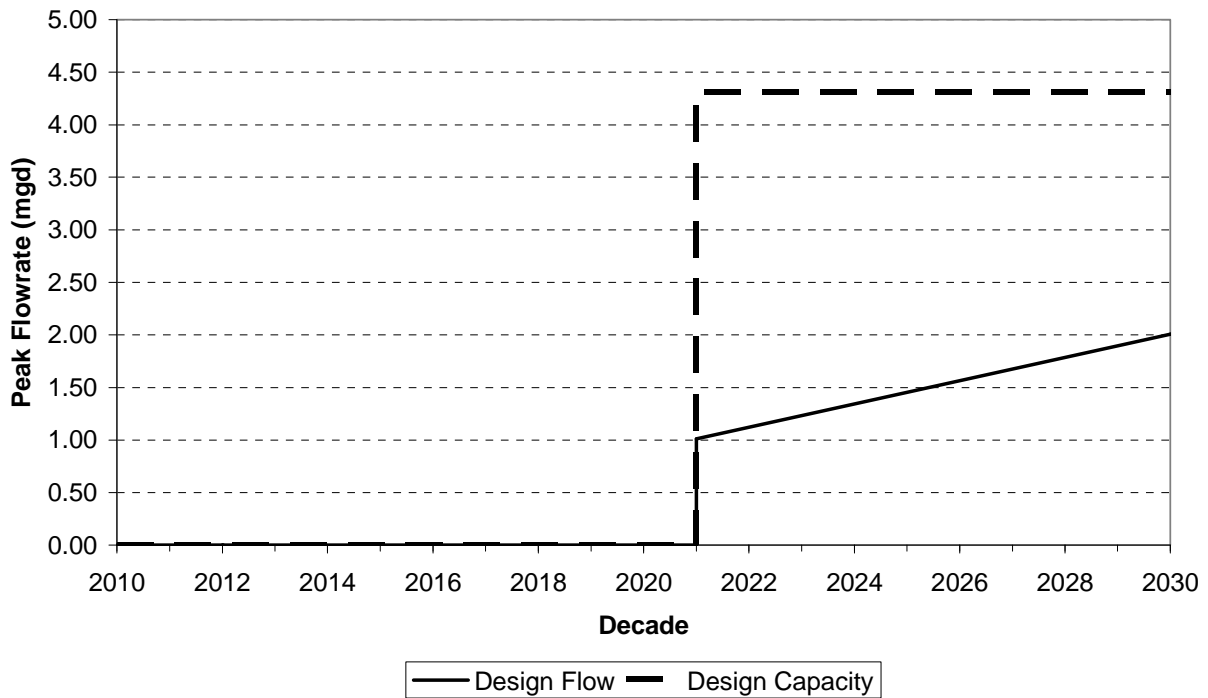
**Figure C-15**  
**Projected Interceptor Flow and Capacity: Segment I-H**



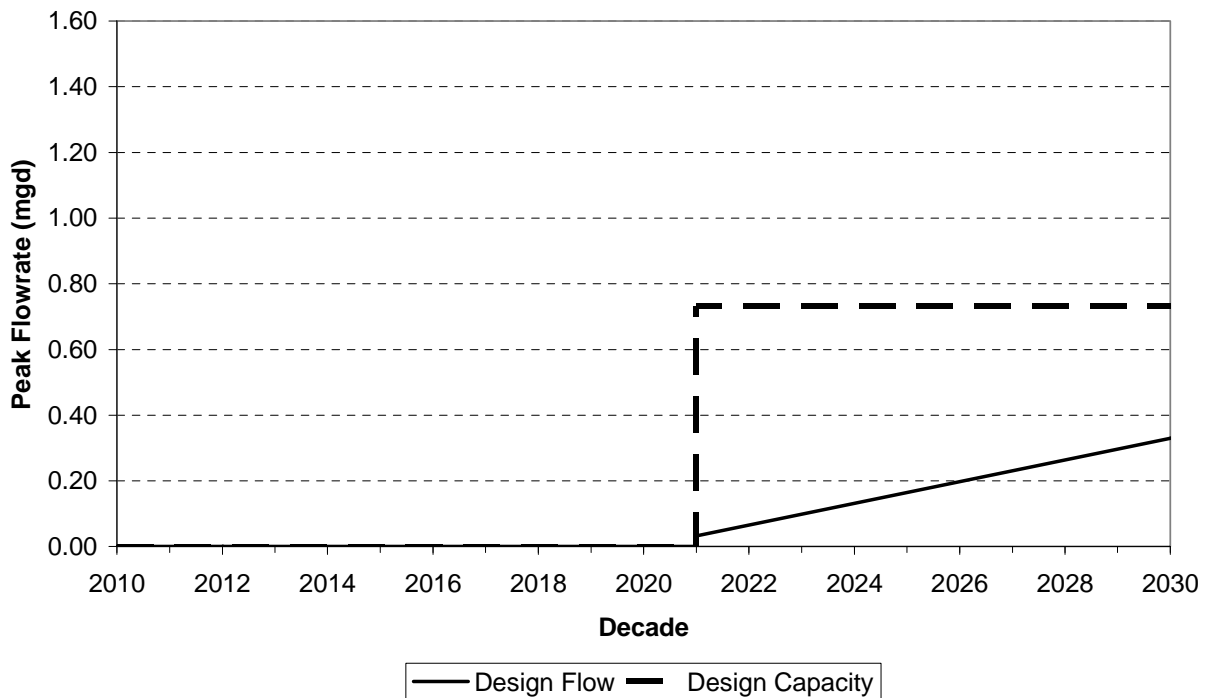
**Figure C-16**  
**Projected Interceptor Flow and Capacity: Segment J-I**



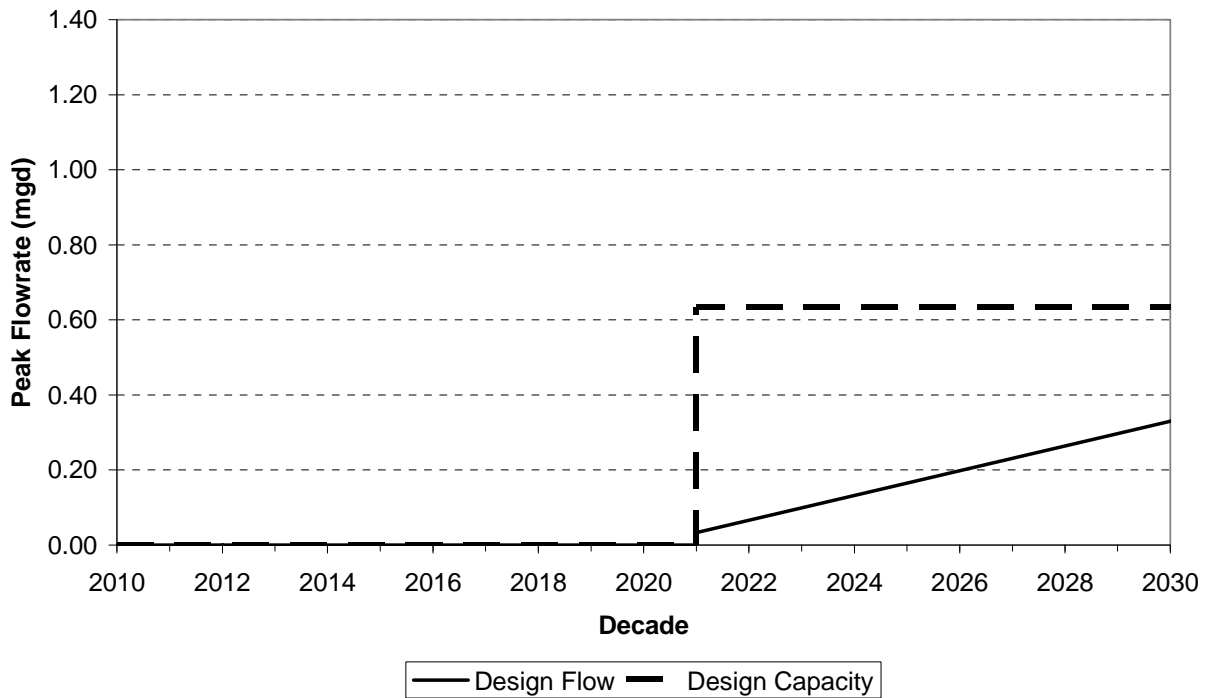
**Figure C-17**  
**Projected Interceptor Flow and Capacity: Segment K-J**



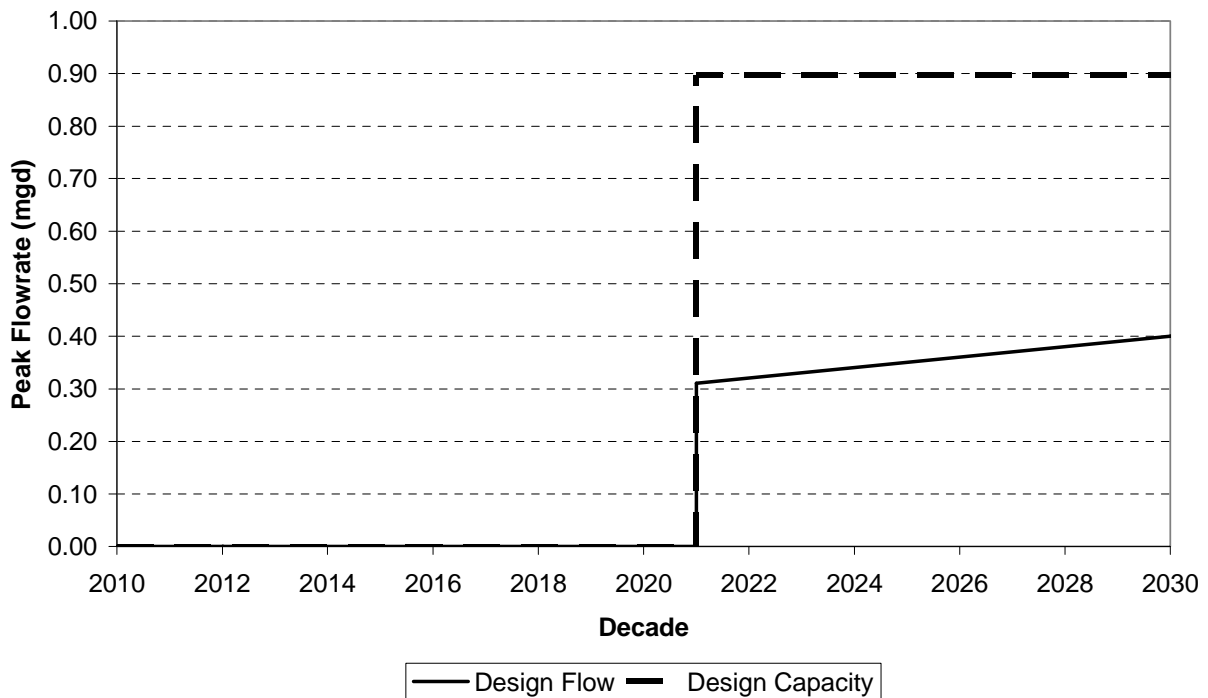
**Figure C-18**  
**Projected Interceptor Flow and Capacity: Segment L-K**



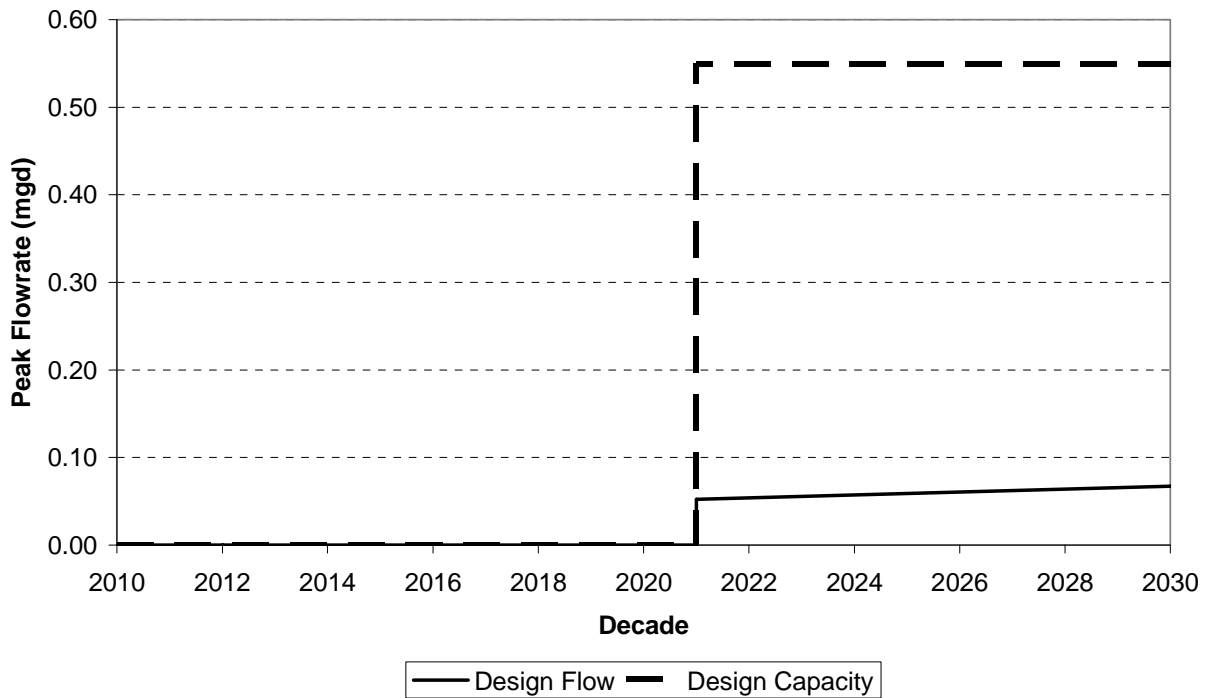
**Figure C-19**  
**Projected Interceptor Flow and Capacity: Segment M-L**



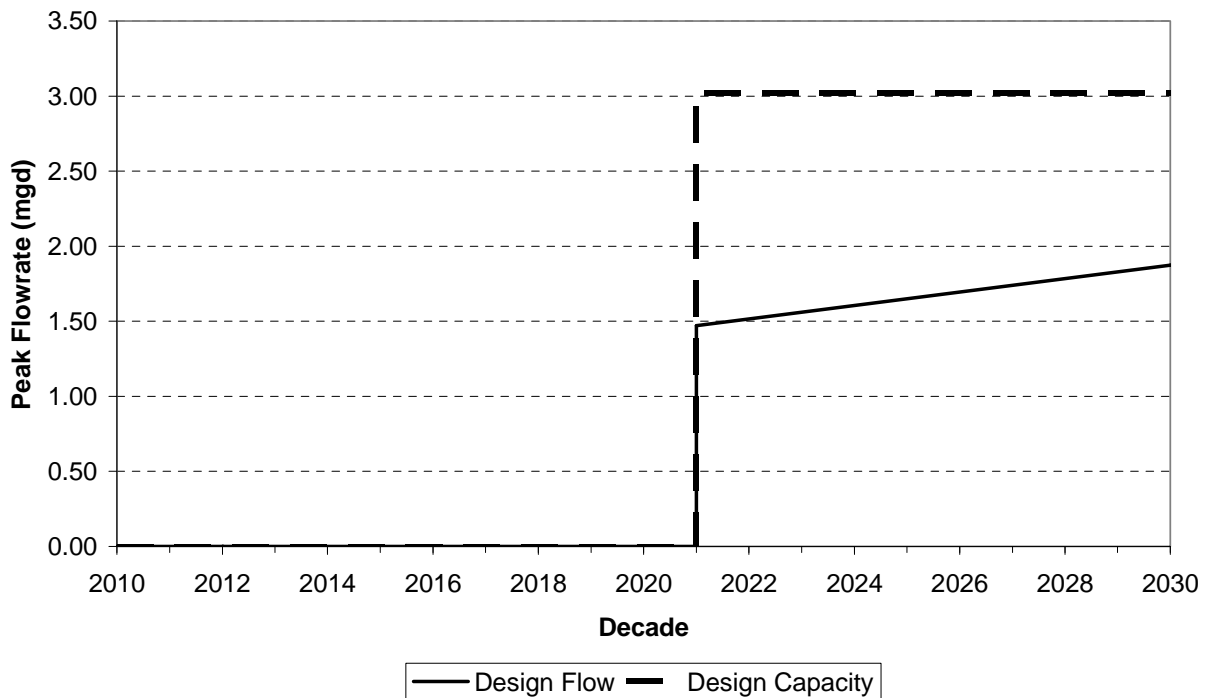
**Figure C-20**  
**Projected Interceptor Flow and Capacity: Segment N-K**



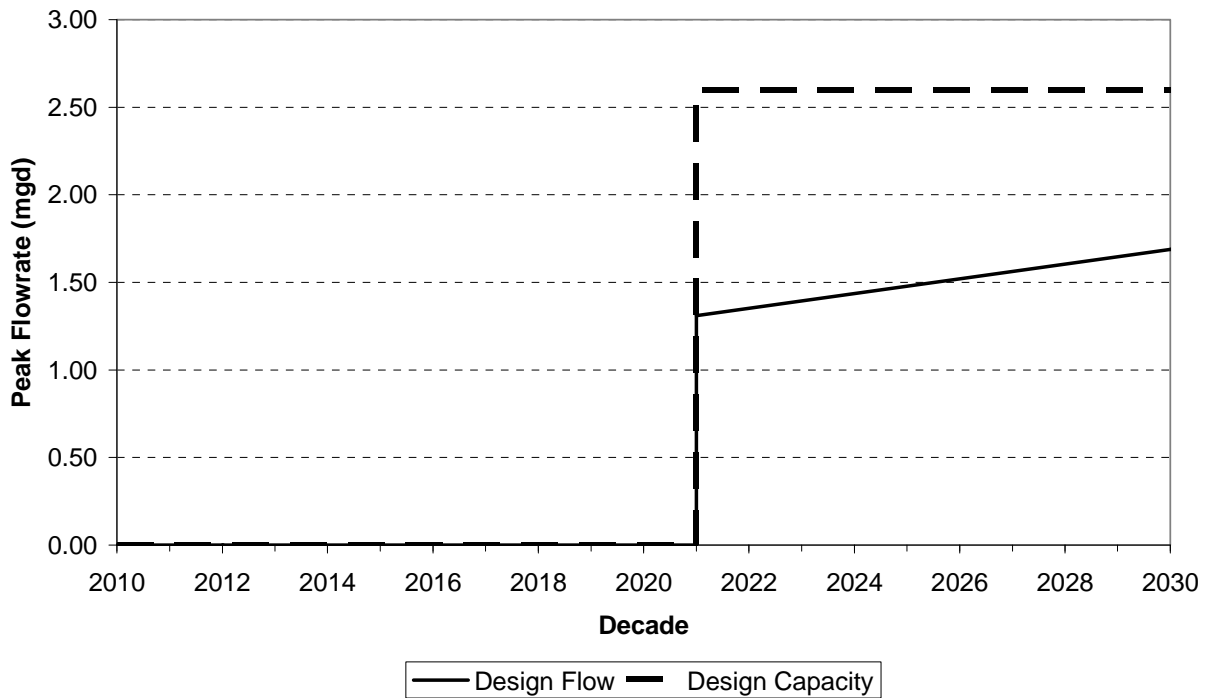
**Figure C-21**  
**Projected Interceptor Flow and Capacity: Segment O-K**



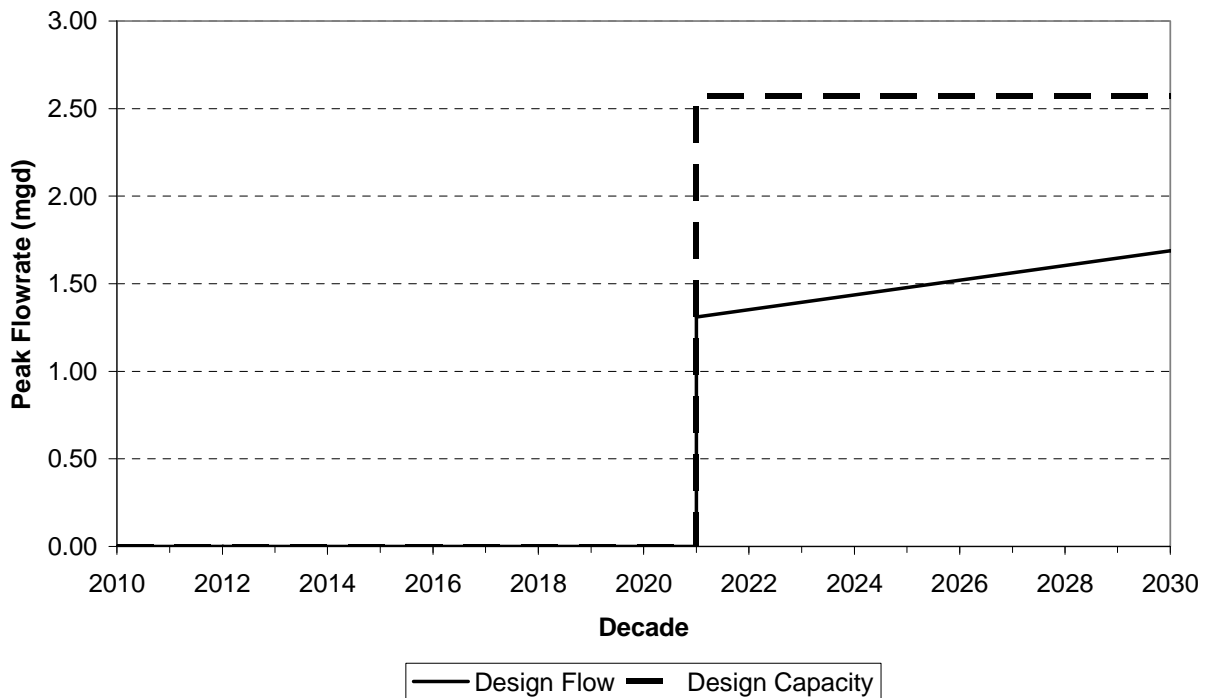
**Figure C-22**  
**Projected Interceptor Flow and Capacity: Segment P-I**



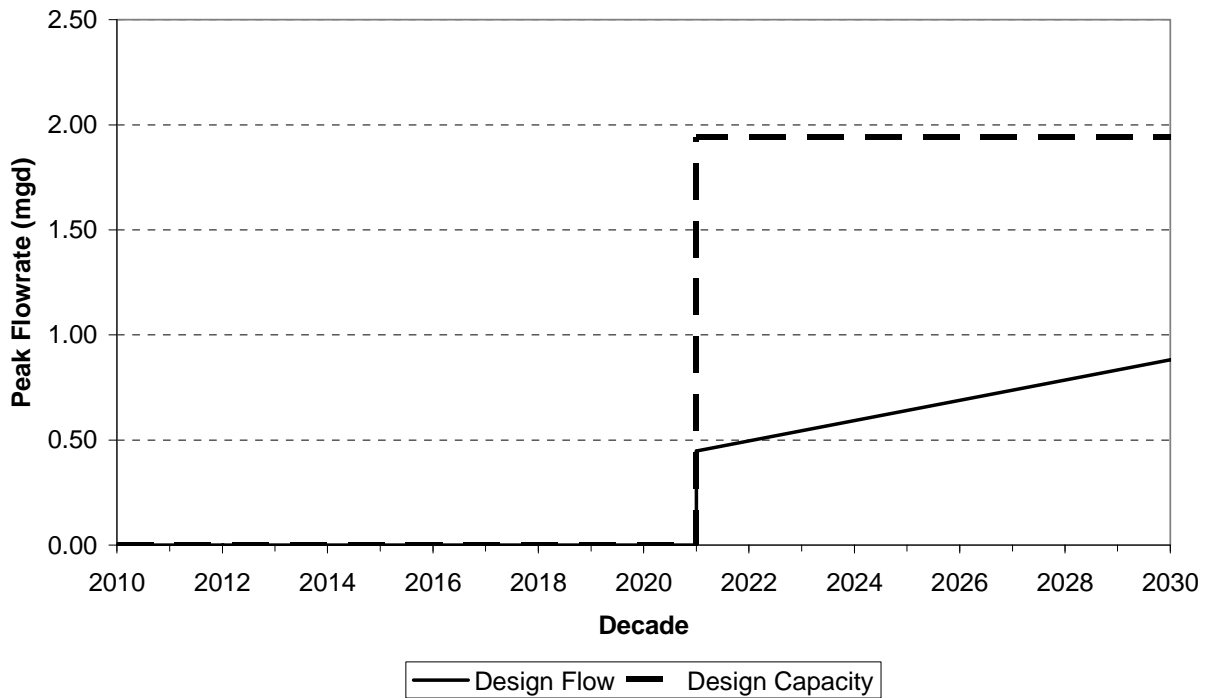
**Figure C-23**  
**Projected Interceptor Flow and Capacity: Segment Q-P**



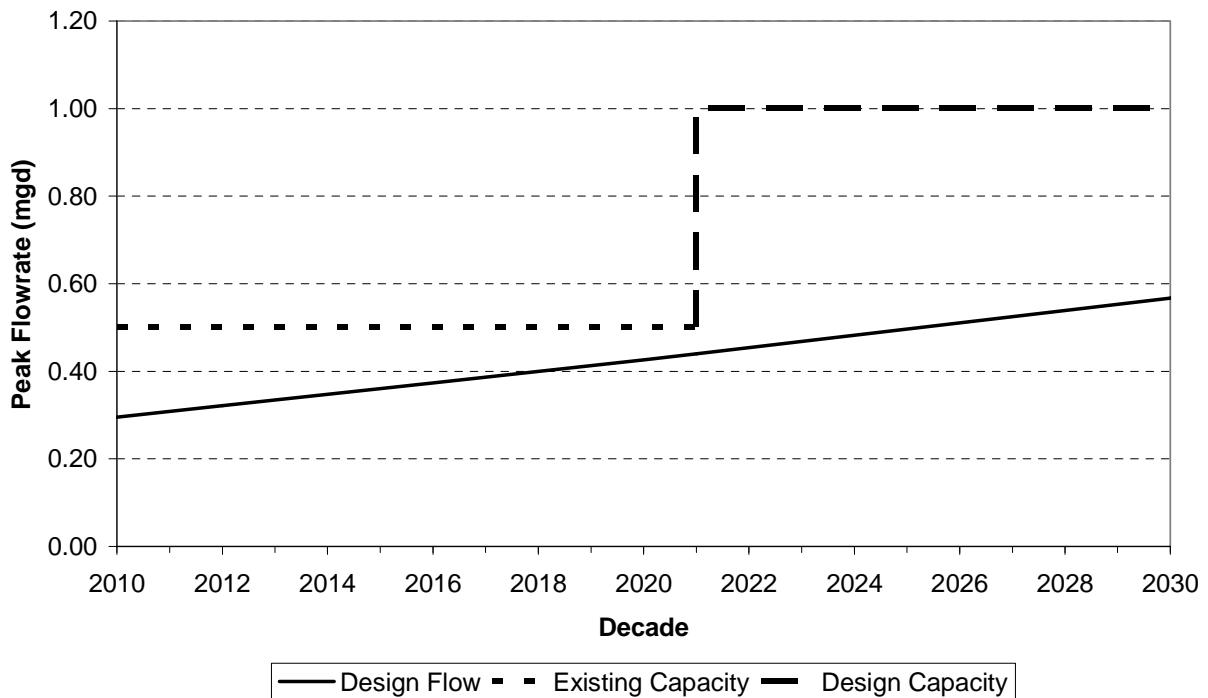
**Figure C-24**  
**Projected Interceptor Flow and Capacity: Segment R-Q**



**Figure C-25**  
**Projected Interceptor Flow and Capacity: Segment S-I**



**Figure C-26**  
**Projected Interceptor Flow and Capacity: Segment AC-AB**





# **Appendix D**

## **Detailed Opinions of Probable Annual Cost**

## **APPENDIX D**

### **DETAILED OPINIONS OF PROBABLE ANNUAL COST**

#### **D.1 INTRODUCTION**

In Chapter 9, opinions of probable annual cost are presented in summary form. This section presents the opinions of probable annual cost in detail.

Table D-1 shows the opinion of probable annual costs throughout the planning period assuming that the project is funded by standard financing, as discussed in Chapter 9.

Table D-2 shows the opinion of probable annual costs throughout the planning period assuming that the project is funded by 50 percent standard financing and 50 percent State Participation Program financing, as discussed in Chapter 9.

**Table D-1**  
**Opinion of Probable Annual Costs**  
**Standard Financing**

Item	Year										
	2012	2013	2014	2015	2016	2017	2018	2019	2020	2021	2022
Projected Annual Average Flow (mgd)	0.71	0.81	0.91	1.01	1.34	1.44	1.54	1.64	1.75	3.05	3.24
Proposed WWTP Capacity (mgd)	1.25	1.25	1.25	1.25	2.50	2.50	2.50	2.50	2.50	5.00	5.00
Proposed Pumping (hp)	7	9	10	12	14	15	17	18	20	75	75
<b>Debt Service (Standard Financing)</b>											
2012 Improvements	\$1,746,319	\$1,746,319	\$1,746,319	\$1,746,319	\$1,746,319	\$1,746,319	\$1,746,319	\$1,746,319	\$1,746,319	\$1,746,319	\$1,746,319
2016 Improvements	\$0	\$0	\$0	\$0	\$945,241	\$945,241	\$945,241	\$945,241	\$945,241	\$945,241	\$945,241
2021 Improvements	\$0	\$0	\$0	\$0	\$0	\$0	\$0	\$0	\$0	\$2,837,206	\$2,837,206
2030 Improvements	\$0	\$0	\$0	\$0	\$0	\$0	\$0	\$0	\$0	\$0	\$0
2040 Improvements	\$0	\$0	\$0	\$0	\$0	\$0	\$0	\$0	\$0	\$0	\$0
2050 Improvements	\$0	\$0	\$0	\$0	\$0	\$0	\$0	\$0	\$0	\$0	\$0
<b>Debt Service (State Participation Program)</b>											
2012 Improvements	\$0	\$0	\$0	\$0	\$0	\$0	\$0	\$0	\$0	\$0	\$0
2016 Improvements	\$0	\$0	\$0	\$0	\$0	\$0	\$0	\$0	\$0	\$0	\$0
2021 Improvements	\$0	\$0	\$0	\$0	\$0	\$0	\$0	\$0	\$0	\$0	\$0
2030 Improvements	\$0	\$0	\$0	\$0	\$0	\$0	\$0	\$0	\$0	\$0	\$0
2040 Improvements	\$0	\$0	\$0	\$0	\$0	\$0	\$0	\$0	\$0	\$0	\$0
2050 Improvements	\$0	\$0	\$0	\$0	\$0	\$0	\$0	\$0	\$0	\$0	\$0
<b>Operation and Maintenance</b>											
<b>Interceptors/Force Mains</b>											
2012 Improvements	\$74,189	\$74,189	\$74,189	\$74,189	\$74,189	\$74,189	\$74,189	\$74,189	\$74,189	\$74,189	\$74,189
2016 Improvements	\$0	\$0	\$0	\$0	\$45,556	\$45,556	\$45,556	\$45,556	\$45,556	\$45,556	\$45,556
2021 Improvements	\$0	\$0	\$0	\$0	\$0	\$0	\$0	\$0	\$0	\$188,522	\$188,522
2030 Improvements	\$0	\$0	\$0	\$0	\$0	\$0	\$0	\$0	\$0	\$0	\$0
2040 Improvements	\$0	\$0	\$0	\$0	\$0	\$0	\$0	\$0	\$0	\$0	\$0
2050 Improvements	\$0	\$0	\$0	\$0	\$0	\$0	\$0	\$0	\$0	\$0	\$0
<b>Lift Stations</b>											
2012 Improvements	\$9,745	\$9,745	\$9,745	\$9,745	\$9,745	\$9,745	\$9,745	\$9,745	\$9,745	\$9,745	\$9,745
2016 Improvements	\$0	\$0	\$0	\$0	\$5,315	\$5,315	\$5,315	\$5,315	\$5,315	\$5,315	\$5,315
2021 Improvements	\$0	\$0	\$0	\$0	\$0	\$0	\$0	\$0	\$0	\$20,890	\$20,890
2030 Improvements	\$0	\$0	\$0	\$0	\$0	\$0	\$0	\$0	\$0	\$0	\$0
2040 Improvements	\$0	\$0	\$0	\$0	\$0	\$0	\$0	\$0	\$0	\$0	\$0
2050 Improvements	\$0	\$0	\$0	\$0	\$0	\$0	\$0	\$0	\$0	\$0	\$0
Power at Lift Stations	\$2,766	\$3,400	\$4,035	\$4,669	\$5,304	\$5,938	\$6,573	\$7,207	\$7,842	\$29,446	\$29,446
<b>WWTP</b>											
Fixed Operations	\$343,741	\$343,741	\$343,741	\$343,741	\$427,589	\$427,589	\$427,589	\$427,589	\$427,589	\$525,555	\$525,555
Variable Operations	\$151,488	\$167,827	\$183,951	\$199,073	\$243,952	\$255,927	\$266,944	\$277,003	\$286,103	\$464,235	\$493,173
Maintenance	\$29,598	\$29,598	\$29,598	\$29,598	\$54,802	\$54,802	\$54,802	\$54,802	\$54,802	\$92,028	\$92,028
<b>Probable Annual Costs (2007 Dollars)</b>	<b>\$2,357,846</b>	<b>\$2,374,819</b>	<b>\$2,391,577</b>	<b>\$2,407,335</b>	<b>\$3,558,012</b>	<b>\$3,570,622</b>	<b>\$3,582,274</b>	<b>\$3,592,967</b>	<b>\$3,602,702</b>	<b>\$6,984,248</b>	<b>\$7,013,186</b>
<b>Probable Unit Costs for Each Year (2007 Dollars per 1,000 Gallons)</b>	<b>\$9.14</b>	<b>\$8.06</b>	<b>\$7.22</b>	<b>\$6.54</b>	<b>\$7.29</b>	<b>\$6.80</b>	<b>\$6.37</b>	<b>\$5.99</b>	<b>\$5.65</b>	<b>\$6.28</b>	<b>\$5.93</b>

Assumptions

Standard Financing

4.5% Interest Rate

20 Loan Term, years

State Participation Financing

5.75% Interest Rate

34 Loan Term, years

**Table D-1**  
**Opinion of Probable Annual Costs**  
**Standard Financing**

Item	Year							
	2023	2024	2025	2026	2027	2028	2029	2030
Projected Annual Average Flow (mgd)	3.43	3.62	3.81	4.00	4.19	4.38	4.57	4.76
Proposed WWTP Capacity (mgd)	5.00	5.00	5.00	5.00	5.00	5.00	5.00	6.25
Proposed Pumping (hp)	78	80	83	85	88	90	93	96
<b>Debt Service (Standard Financing)</b>								
2012 Improvements	\$1,746,319	\$1,746,319	\$1,746,319	\$1,746,319	\$1,746,319	\$1,746,319	\$1,746,319	\$1,746,319
2016 Improvements	\$945,241	\$945,241	\$945,241	\$945,241	\$945,241	\$945,241	\$945,241	\$945,241
2021 Improvements	\$2,837,206	\$2,837,206	\$2,837,206	\$2,837,206	\$2,837,206	\$2,837,206	\$2,837,206	\$2,837,206
2030 Improvements	\$0	\$0	\$0	\$0	\$0	\$0	\$0	\$942,658
2040 Improvements	\$0	\$0	\$0	\$0	\$0	\$0	\$0	\$0
2050 Improvements	\$0	\$0	\$0	\$0	\$0	\$0	\$0	\$0
<b>Debt Service (State Participation Program)</b>								
2012 Improvements	\$0	\$0	\$0	\$0	\$0	\$0	\$0	\$0
2016 Improvements	\$0	\$0	\$0	\$0	\$0	\$0	\$0	\$0
2021 Improvements	\$0	\$0	\$0	\$0	\$0	\$0	\$0	\$0
2030 Improvements	\$0	\$0	\$0	\$0	\$0	\$0	\$0	\$0
2040 Improvements	\$0	\$0	\$0	\$0	\$0	\$0	\$0	\$0
2050 Improvements	\$0	\$0	\$0	\$0	\$0	\$0	\$0	\$0
<b>Operation and Maintenance</b>								
<b>Interceptors/Force Mains</b>								
2012 Improvements	\$74,189	\$74,189	\$74,189	\$74,189	\$74,189	\$74,189	\$74,189	\$74,189
2016 Improvements	\$45,556	\$45,556	\$45,556	\$45,556	\$45,556	\$45,556	\$45,556	\$45,556
2021 Improvements	\$188,522	\$188,522	\$188,522	\$188,522	\$188,522	\$188,522	\$188,522	\$188,522
2030 Improvements	\$0	\$0	\$0	\$0	\$0	\$0	\$0	\$0
2040 Improvements	\$0	\$0	\$0	\$0	\$0	\$0	\$0	\$0
2050 Improvements	\$0	\$0	\$0	\$0	\$0	\$0	\$0	\$0
<b>Lift Stations</b>								
2012 Improvements	\$9,745	\$9,745	\$9,745	\$9,745	\$9,745	\$9,745	\$9,745	\$9,745
2016 Improvements	\$5,315	\$5,315	\$5,315	\$5,315	\$5,315	\$5,315	\$5,315	\$5,315
2021 Improvements	\$20,890	\$20,890	\$20,890	\$20,890	\$20,890	\$20,890	\$20,890	\$20,890
2030 Improvements	\$0	\$0	\$0	\$0	\$0	\$0	\$0	\$8,723
2040 Improvements	\$0	\$0	\$0	\$0	\$0	\$0	\$0	\$0
2050 Improvements	\$0	\$0	\$0	\$0	\$0	\$0	\$0	\$0
Power at Lift Stations	\$30,448	\$31,449	\$32,450	\$33,451	\$34,453	\$35,454	\$36,455	\$37,457
<b>WWTP</b>								
Fixed Operations	\$525,555	\$525,555	\$525,555	\$525,555	\$525,555	\$525,555	\$525,555	\$551,094
Variable Operations	\$522,111	\$551,049	\$579,987	\$608,924	\$637,862	\$666,800	\$695,738	\$724,676
Maintenance	\$92,028	\$92,028	\$92,028	\$92,028	\$92,028	\$92,028	\$92,028	\$115,035
<b>Probable Annual Costs (2007 Dollars)</b>	<b>\$7,043,125</b>	<b>\$7,073,064</b>	<b>\$7,103,003</b>	<b>\$7,132,943</b>	<b>\$7,162,882</b>	<b>\$7,192,821</b>	<b>\$7,222,760</b>	<b>\$8,252,626</b>
<b>Probable Unit Costs for Each Year (2007 Dollars per 1,000 Gallons)</b>	<b>\$5.63</b>	<b>\$5.35</b>	<b>\$5.11</b>	<b>\$4.89</b>	<b>\$4.68</b>	<b>\$4.50</b>	<b>\$4.33</b>	<b>\$4.75</b>

Assumptions

Standard Financing

4.5% Interest Rate

20 Loan Term, years

State Participation Financing

5.75% Interest Rate

34 Loan Term, years

**Table D-2**  
**Opinion of Probable Annual Costs**  
**50 Percent State Participation Financing**

Item	Year										
	2012	2013	2014	2015	2016	2017	2018	2019	2020	2021	2022
Projected Annual Average Flow (mgd)	0.71	0.81	0.91	1.01	1.34	1.44	1.54	1.64	1.75	3.05	3.24
Proposed WWTP Capacity (mgd)	1.25	1.25	1.25	1.25	2.50	2.50	2.50	2.50	2.50	5.00	5.00
Proposed Pumping (hp)	7	9	10	12	14	15	17	18	20	75	75
<b>Debt Service (Standard Financing)</b>											
2012 Improvements	\$873,160	\$873,160	\$873,160	\$873,160	\$873,160	\$873,160	\$873,160	\$873,160	\$873,160	\$873,160	\$873,160
2016 Improvements	\$0	\$0	\$0	\$0	\$472,621	\$472,621	\$472,621	\$472,621	\$472,621	\$472,621	\$472,621
2021 Improvements	\$0	\$0	\$0	\$0	\$0	\$0	\$0	\$0	\$0	\$1,418,603	\$1,418,603
2030 Improvements	\$0	\$0	\$0	\$0	\$0	\$0	\$0	\$0	\$0	\$0	\$0
2040 Improvements	\$0	\$0	\$0	\$0	\$0	\$0	\$0	\$0	\$0	\$0	\$0
2050 Improvements	\$0	\$0	\$0	\$0	\$0	\$0	\$0	\$0	\$0	\$0	\$0
<b>Debt Service (State Participation Program)</b>											
2012 Improvements	\$0	\$0	\$127,902	\$126,426	\$187,299	\$246,431	\$334,044	\$418,687	\$500,112	\$578,048	\$567,135
2016 Improvements	\$0	\$0	\$0	\$0	\$0	\$0	\$69,230	\$68,432	\$101,380	\$133,387	\$180,810
2021 Improvements	\$0	\$0	\$0	\$0	\$0	\$0	\$0	\$0	\$0	\$0	\$0
2030 Improvements	\$0	\$0	\$0	\$0	\$0	\$0	\$0	\$0	\$0	\$0	\$0
2040 Improvements	\$0	\$0	\$0	\$0	\$0	\$0	\$0	\$0	\$0	\$0	\$0
2050 Improvements	\$0	\$0	\$0	\$0	\$0	\$0	\$0	\$0	\$0	\$0	\$0
<b>Operation and Maintenance</b>											
<b>Interceptors/Force Mains</b>											
2012 Improvements	\$74,189	\$74,189	\$74,189	\$74,189	\$74,189	\$74,189	\$74,189	\$74,189	\$74,189	\$74,189	\$74,189
2016 Improvements	\$0	\$0	\$0	\$0	\$45,556	\$45,556	\$45,556	\$45,556	\$45,556	\$45,556	\$45,556
2021 Improvements	\$0	\$0	\$0	\$0	\$0	\$0	\$0	\$0	\$0	\$188,522	\$188,522
2030 Improvements	\$0	\$0	\$0	\$0	\$0	\$0	\$0	\$0	\$0	\$0	\$0
2040 Improvements	\$0	\$0	\$0	\$0	\$0	\$0	\$0	\$0	\$0	\$0	\$0
2050 Improvements	\$0	\$0	\$0	\$0	\$0	\$0	\$0	\$0	\$0	\$0	\$0
<b>Lift Stations</b>											
2012 Improvements	\$9,745	\$9,745	\$9,745	\$9,745	\$9,745	\$9,745	\$9,745	\$9,745	\$9,745	\$9,745	\$9,745
2016 Improvements	\$0	\$0	\$0	\$0	\$5,315	\$5,315	\$5,315	\$5,315	\$5,315	\$5,315	\$5,315
2021 Improvements	\$0	\$0	\$0	\$0	\$0	\$0	\$0	\$0	\$0	\$20,890	\$20,890
2030 Improvements	\$0	\$0	\$0	\$0	\$0	\$0	\$0	\$0	\$0	\$0	\$0
2040 Improvements	\$0	\$0	\$0	\$0	\$0	\$0	\$0	\$0	\$0	\$0	\$0
2050 Improvements	\$0	\$0	\$0	\$0	\$0	\$0	\$0	\$0	\$0	\$0	\$0
Power at Lift Stations	\$2,766	\$3,400	\$4,035	\$4,669	\$5,304	\$5,938	\$6,573	\$7,207	\$7,842	\$29,446	\$29,446
<b>WWTP</b>											
Fixed Operations	\$343,741	\$343,741	\$343,741	\$343,741	\$427,589	\$427,589	\$427,589	\$427,589	\$427,589	\$525,555	\$525,555
Variable Operations	\$151,488	\$167,827	\$183,951	\$199,073	\$243,952	\$255,927	\$266,944	\$277,003	\$286,103	\$464,235	\$493,173
Maintenance	\$29,598	\$29,598	\$29,598	\$29,598	\$54,802	\$54,802	\$54,802	\$54,802	\$54,802	\$92,028	\$92,028
<b>Probable Annual Costs (2007 Dollars)</b>	<b>\$1,484,686</b>	<b>\$1,501,659</b>	<b>\$1,646,320</b>	<b>\$1,660,602</b>	<b>\$2,399,531</b>	<b>\$2,471,273</b>	<b>\$2,639,767</b>	<b>\$2,734,306</b>	<b>\$2,858,414</b>	<b>\$4,931,300</b>	<b>\$4,996,748</b>
<b>Probable Unit Costs for Each Year (2007 Dollars per 1,000 Gallons)</b>	<b>\$5.76</b>	<b>\$5.10</b>	<b>\$4.97</b>	<b>\$4.51</b>	<b>\$4.92</b>	<b>\$4.71</b>	<b>\$4.69</b>	<b>\$4.56</b>	<b>\$4.48</b>	<b>\$4.43</b>	<b>\$4.23</b>

Assumptions

Standard Financing

4.5% Interest Rate

20 Loan Term, years

State Participation Financing

5.75% Interest Rate

34 Loan Term, years

**Table D-2**  
**Opinion of Probable Annual Costs**  
**50 Percent State Participation Financing**

Item	Year							
	2023	2024	2025	2026	2027	2028	2029	2030
Projected Annual Average Flow (mgd)	3.43	3.62	3.81	4.00	4.19	4.38	4.57	4.76
Proposed WWTP Capacity (mgd)	5.00	5.00	5.00	5.00	5.00	5.00	5.00	6.25
Proposed Pumping (hp)	78	80	83	85	88	90	93	96
<b>Debt Service (Standard Financing)</b>								
2012 Improvements	\$873,160	\$873,160	\$873,160	\$873,160	\$873,160	\$873,160	\$873,160	\$873,160
2016 Improvements	\$472,621	\$472,621	\$472,621	\$472,621	\$472,621	\$472,621	\$472,621	\$472,621
2021 Improvements	\$1,418,603	\$1,418,603	\$1,418,603	\$1,418,603	\$1,418,603	\$1,418,603	\$1,418,603	\$1,418,603
2030 Improvements	\$0	\$0	\$0	\$0	\$0	\$0	\$0	\$471,329
2040 Improvements	\$0	\$0	\$0	\$0	\$0	\$0	\$0	\$0
2050 Improvements	\$0	\$0	\$0	\$0	\$0	\$0	\$0	\$0
<b>Debt Service (State Participation Program)</b>								
2012 Improvements	\$555,595	\$1,066,901	\$1,053,996	\$1,040,348	\$1,025,916	\$1,010,655	\$994,515	\$977,448
2016 Improvements	\$226,626	\$270,699	\$312,884	\$306,977	\$300,731	\$577,488	\$570,503	\$563,116
2021 Improvements	\$207,800	\$205,402	\$304,300	\$400,371	\$542,713	\$680,232	\$812,521	\$939,141
2030 Improvements	\$0	\$0	\$0	\$0	\$0	\$0	\$0	\$0
2040 Improvements	\$0	\$0	\$0	\$0	\$0	\$0	\$0	\$0
2050 Improvements	\$0	\$0	\$0	\$0	\$0	\$0	\$0	\$0
<b>Operation and Maintenance</b>								
<b>Interceptors/Force Mains</b>								
2012 Improvements	\$74,189	\$74,189	\$74,189	\$74,189	\$74,189	\$74,189	\$74,189	\$74,189
2016 Improvements	\$45,556	\$45,556	\$45,556	\$45,556	\$45,556	\$45,556	\$45,556	\$45,556
2021 Improvements	\$188,522	\$188,522	\$188,522	\$188,522	\$188,522	\$188,522	\$188,522	\$188,522
2030 Improvements	\$0	\$0	\$0	\$0	\$0	\$0	\$0	\$0
2040 Improvements	\$0	\$0	\$0	\$0	\$0	\$0	\$0	\$0
2050 Improvements	\$0	\$0	\$0	\$0	\$0	\$0	\$0	\$0
<b>Lift Stations</b>								
2012 Improvements	\$9,745	\$9,745	\$9,745	\$9,745	\$9,745	\$9,745	\$9,745	\$9,745
2016 Improvements	\$5,315	\$5,315	\$5,315	\$5,315	\$5,315	\$5,315	\$5,315	\$5,315
2021 Improvements	\$20,890	\$20,890	\$20,890	\$20,890	\$20,890	\$20,890	\$20,890	\$20,890
2030 Improvements	\$0	\$0	\$0	\$0	\$0	\$0	\$0	\$8,723
2040 Improvements	\$0	\$0	\$0	\$0	\$0	\$0	\$0	\$0
2050 Improvements	\$0	\$0	\$0	\$0	\$0	\$0	\$0	\$0
Power at Lift Stations	\$30,448	\$31,449	\$32,450	\$33,451	\$34,453	\$35,454	\$36,455	\$37,457
<b>WWTP</b>								
Fixed Operations	\$525,555	\$525,555	\$525,555	\$525,555	\$525,555	\$525,555	\$525,555	\$551,094
Variable Operations	\$522,111	\$551,049	\$579,987	\$608,924	\$637,862	\$666,800	\$695,738	\$724,676
Maintenance	\$92,028	\$92,028	\$92,028	\$92,028	\$92,028	\$92,028	\$92,028	\$115,035
<b>Probable Annual Costs (2007 Dollars)</b>	<b>\$5,268,762</b>	<b>\$5,851,683</b>	<b>\$6,009,799</b>	<b>\$6,116,256</b>	<b>\$6,267,859</b>	<b>\$6,696,812</b>	<b>\$6,835,915</b>	<b>\$7,496,619</b>
<b>Probable Unit Costs for Each Year (2007 Dollars per 1,000 Gallons)</b>	<b>\$4.21</b>	<b>\$4.43</b>	<b>\$4.32</b>	<b>\$4.19</b>	<b>\$4.10</b>	<b>\$4.19</b>	<b>\$4.10</b>	<b>\$4.32</b>

Assumptions

Standard Financing

4.5% Interest Rate

20 Loan Term, years

State Participation Financing

5.75% Interest Rate

34 Loan Term, years

# **Appendix E**

## **Summary of Public Meetings**

## APPENDIX E

### SUMMARY OF PUBLIC MEETINGS

#### E.1 INTRODUCTION

Three public meetings were held to solicit public comments about the Plan. Each is discussed in detail below.

#### E.2 PUBLIC MEETING #1

The Participants conducted the first of three public meetings on October 2, 2006, at Aledo High School in Aledo. After a short presentation by Alan Plummer Associates, Inc. (APAI) to introduce the Eastern Parker County Regional Wastewater Facilities Plan project and present information about projected populations, projected wastewater flows, and potential regional WWTP sites, public questions and comments were requested. The following summary of public comments, public questions, and consultant responses has been condensed and paraphrased. A copy of the attendance record is attached at the end of this Appendix. Some of those presenting comments do not appear on the attendance list, so some names are incomplete.

Martha \_\_\_\_\_: Where will the proposed treatment plants be located?

APAI: We have not studied this issue beyond drawing the large circles on the maps in the presentation. This study will not reach the level of recommending individual properties. We will evaluate the feasibility of a regional wastewater treatment system, and the feasibility of this system will not depend on any one individual property. If a plant location must be moved ¼-mile or ½-mile, it will probably not affect the conclusions of the study.

Dwayne Ford: What footprint is necessary for a wastewater treatment plant?

APAI: Total wastewater flow from the planning area during the planning period will be about 8-9 MGD. The property requirement must account for treatment units and a buffer zone. We anticipate that a wastewater treatment plant would need a property of approximately 10 to 20 acres.



Steve Barron: Are you looking at advanced technology for the treatment plant(s)?

APAI: Current technology can treat wastewater to a water quality that is better than the river to which it is discharged. We will also be looking at technology that is sufficient to meet standards for reclaimed water use, or reuse. Reuse opportunities include irrigation of golf courses, lawns, and school grounds/playing fields. We will discuss treatment technology further at the next public meeting.

Gerhard Kleinschmidt: Is the technology available to allow use of reclaimed water for potable drinking water?

APAI: Direct potable reuse is not legal at this time. Instead, some utilities blend reclaimed water with natural water in a reservoir and treat the resulting water for indirect potable reuse.

Gerhard Kleinschmidt: Will the treatment plant stink?

APAI: Treatment facilities can be built so that there is little odor. With appropriate technology, treatment facilities can be located relatively close to neighbors without a problem. However, we cannot guarantee that it will be odor-free 100 percent of the time.

Dwayne Ford: Gas companies are putting in a network of pipes that criss-cross Parker County. Are you considering this in your analysis?

APAI: No.

Marilyn Morrill: Where can citizens get copies of the information presented? Is there a web site?

APAI: There is not a web site. The draft report will be publicly available prior to the last public meeting.

Dwayne Ford: Are you keeping an administrative record?

APAI: We are keeping records of public questions and comments.

Martin Siegmund: Favors regional wastewater treatment rather than small cities providing their own treatment. Does not think the issue needs further study – should buy the land, build a plant, and get to work. People do not care who provides treatment for

their wastewater. Aledo discharges 350,000 gallons per day that could be used for reuse. Aledo is seeking to double their treatment plant size – Mr. Siegmund opposes this.

Gary \_\_\_\_\_: Fort Worth was considering a treatment plant to provide service to the Walsh Ranch area. Will you consider this in the study?

APAI: Yes, the Mary's Creek Water Recycling Center is the plant contemplated by Fort Worth to serve the Walsh Ranch area, which is adjacent to the regional planning area. We are considering whether it is feasible to include this plant in a Parker County regional system.

\_\_\_\_\_ : Can the treatment plant be located in a flood plain?

APAI: A treatment plant must be protected from the 100-year flood. There are two ways to accomplish this: 1) to locate it outside the 100-year flood plain or 2) to build a levee around the plant that would be higher than the 100-year flood elevation.

\_\_\_\_\_ : Will the existing treatment plants continue to operate?

APAI: We will evaluate the issue of whether it is more cost-effective to retire existing plants or to continue using them.

Katherine \_\_\_\_\_: Will wastewater be sent to the planning area from the Mary's Creek Water Recycling Center or vice versa?

APAI: We will evaluate both options.

\_\_\_\_\_ : How will notification be provided for the next two public meetings?

A.G. Swan, Parker County Utility District No. 1: For this meeting, notice was published in the Weatherford Democrat, the Community News, and the Shopper and notices were submitted to the County Clerk's office and posted at the City Hall of each municipal participant.

APAI: The notice procedure will be the same for the next two public meetings.

### **E.3 PUBLIC MEETING #2**

The Participants conducted the second of three public meetings on December 18, 2006, at Aledo High School in Aledo to present preliminary recommendations for a regional collection system and a regional Clear Fork WWTP. After a brief presentation by APAI, public comments and questions were requested. The following summary of public comments, public questions, and consultant responses has been condensed and paraphrased. A copy of the attendance record is attached at the end of this Appendix.

Jim Beech: Are decentralized wastewater treatment systems being considered?

APAI: No, our task is to identify potential regional centralized wastewater treatment plants as part of a regional wastewater collection and treatment system. We are open to discussion of decentralized wastewater treatment if it can fit into a regional system and reduce system costs.

### **E.4 PUBLIC MEETING #3**

The Participants conducted the third of three public meetings on June 25, 2007, at Aledo High School in Aledo to present the Draft Eastern Parker County Regional Wastewater Facilities Plan to the public and solicit public input. Brian McDonald of Alan Plummer Associates, Inc. (APAI) convened the public meeting and noted that each person in the audience was affiliated with one of the Participants in the study. Mr. McDonald explained that he had prepared a presentation summarizing the Draft Eastern Parker County Regional Wastewater Facilities Plan but that all information in the presentation has previously been discussed at project meetings with the Participants. Mr. McDonald offered to present the material, but none of the attendees indicated an interest in hearing the presentation.

Mr. McDonald then opened the meeting to questions about the Plan. A summary of the discussion, which has been condensed and paraphrased, is presented below. After discussion came to an end, Mr. McDonald reviewed the project schedule with the attendees, noting that he expects to receive comments about the Draft Plan from the Texas Water Development Board within a week and that this may necessitate another project meeting with the Participants, depending on the nature of the comments. Mr.

McDonald then adjourned the public meeting. A copy of the attendance record is attached.

Dwayne Ford: Willow Park recently rejected an offer to purchase the Deer Creek Waterworks utility systems. Are changes to the Plan necessary to reflect this development?

APA: The Draft Plan does not speculate about a potential sale of the Deer Creek Waterworks system and assumes that Willow Park will continue to operate it. Therefore, no changes to the Plan will be necessary.

Public Meeting Sign-In Sheet  
 Eastern Parker County Regional Wastewater Facilities Plan  
 October 2, 2006

Name	City	Phone Number	Email Address
1 Janet Farrar	Annetta North	817-441-6109	underwood@aledobbb.com
2 Duwayne Ford	Annetta North	817-441-6109	underwood@aledobbb.com
3 Daniel Brannigan	Aledo	817-441-7661	dbrannigan@community-news.com
4 Debbie Gillum	Aledo	817-441-5224	
5 JEANNE YODER	PARKER CO		
6 DICK YODER	Willow Park	817-441-9537	ryoder@hotmail.com
7 Kimberly Hardick	Aledo	4416206	Kimberly@ALEDO.YOGA.COM
8 Marilyn Marshall	Aledo	817-441-2002	MARILYN.MARSHALL@SHRGLOBAL.NET
9 William G Mitchell	ALEDO	817-441-8910	ALEDOTEXAS@AOL.COM
10 Steve Bossi	Annetta	817-441-2347	slorri@wed-woodvch.com
11 Mike Connelley	Annetta N	817-441-7774	MIKEFB@CPA@excite.COM
12 BRIAN McDONALD	ALAN PLUMMER ASSOC.	817-806-1700	bmsdonald@apainv.com
13			
14			
15			
16			
17			
18			
19			
20			
21			
22			
23			
24			
25			
26			
27			

Public Meeting Sign-In Sheet  
 Eastern Parker County Regional Wastewater Facilities Plan  
 October 2, 2006

	Name	City	Phone Number	Email Address
82	Jim Caspiter	Aledo	817/641-9733	
83	Paul Shultz	Weslaco	817-557-7424	
84	J. KRIG KAHLOK	Weslaco	817-598-9250	kkahler@ci.weatherford.tx.us
85	Richard S. Talley	Fort Worth	817-392-8203	Richard.talley@fortworthgov.org
86	Mack Wofford	Aledo	817-441-7016	Mack.Wofford@Aledo-Texas.com
87	Wayne Sabara	PCUD	817-925-4857	WLIA@YAHOO.COM
88	Richard Smith	AAA	817-866-1716	Richard@aprimy.ca
89				
90				
91				
92				
93				
94				
95				
96				
97				
98				
99				
100				
101				
102				
103				
104				
105				
106				
107				
108				

Public Meeting Sign-In Sheet  
 Eastern Parker County Regional Wastewater Facilities Plan  
 October 2, 2006

	Name	City	Phone Number	Email Address
55	MARVIN GLASSOW	WILLOW PARK	817-441-7108	
56	Betty Jordan	Alan Plummer Assoc	817-806-1700	bjordan@apaciv.com
57				
58				
59				
60				
61				
62				
63				
64				
65				
66				
67				
68				
69				
70				
71				
72				
73				
74				
75				
76				
77				
78				
79				
80				
81				

Public Meeting Sign-In Sheet  
 Eastern Parker County Regional Wastewater Facilities Plan  
 October 2, 2006

	Name	City	Phone Number	Email Address
28	Olga Lusk	ANNETTA	8174419073	US#BZB@AOL.COM & SOC@LORIAN.NEY
29	PAUL LUMSDEN	ANNETTA	817/441-2633	PHIL@LUMSDEN.AOL.COM
30				
31				
32				
33				
34				
35				
36				
37				
38				
39				
40				
41				
42				
43				
44				
45				
46				
47				
48				
49				
50				
51				
52				
53				
54				



Public Meeting Sign-In Sheet  
 Eastern Parker County Regional Wastewater Facilities Plan  
 December 18, 2006

	Name	City	Phone Number	Email Address
1	Brian McDonald	Alan Plummers Assoc.	817-806-1700	bmcDonald@apacienv.com
2	GARY BURTON	ALEDO/GOBI	973-561-6984	gburton@96ci-tx.com
3	Richard Talley	Fort Worth	817-392-8203	Richard.Talley@fortworthgov.org
4	RON MANESS	GE/Zenon	630 659 0876	ronak.maness@ge.com
5	Herschell Wurfrey	GE/Zenon	817-249-6941	Hwurfrey@ge.com
6	PATTY BEGGH	FARMERS BRANCH	214-420-8700	patty.begg@consentec.de.com
7	JIM BEGGH	FARMERS BRANCH	214-420-8770	jim.begg@consentec.de.com
8	KRALK KAHUK	Weatherford	817-598-4250	kralk@weatherford.tx.us
9	DR. PAUL PHILLIPS	"	817-579-7427	WPH11@SDC-Golf.L.net
10	SHARON HAYES	"	817-598-4270	shayes@ci.weatherford.tx.us
11	Frank Crumbo	City of Ft Worth	" 392-8246	
12	AG SWAN	PCPD	817 220 5585	AGSWAN@EMT/CAR.NET
13	John D'Antonio	Alan Plummers Assoc.	817 806 1700	Jdantoni@apacienv.com
14	Sharon Hayes	Weatherford		
15				
16				
17				
18				
19				
20				
21				
22				
23				
24				
25				
26				
27				

Public Meeting Sign-In Sheet  
 Eastern Parker County Regional Wastewater Facilities Plan  
 June 25, 2007

	Name	City	Phone Number	Email Address
1	MARK R. ERNST	TRWD	817-237-8585	mernst@trwd.com
2	Wayne Ford	Annaeta North	817-441-6109	underwood@alestokb.com
3	Janet Farber	"	"	"
4	GORDON SMITH	ALCO	817 441 7014	601
5	Paul Phillips	Deer Park	817 554 7427	WPHill@SBCGlobal.net
6	Sharon Hough	Weatherford	817-598-4270	sharon@weatherfordtx.gov
7	A G SWAN	PCO	817 523 7555	AGSWAN@EMRATX.ORG
8	BILL GORDON	ANNETTA SOUTH	817-441-8632	fwgordon@att.net
9	BARBARA BARR	UNDERWOOD	817-594-0239	BARBARA@COOK-PCO.COM
10				
11				
12				
13				
14				
15				
16				
17				
18				
19				
20				
21				
22				
23				
24				
25				
26				
27				

**Appendix F**

**Texas Water**

**Development Board**

**Comments**



# TEXAS WATER DEVELOPMENT BOARD



E. G. Rod Pittman, *Chairman*  
William W. Meadows, *Member*  
Dario Vidal Guerra, Jr., *Member*

J. Kevin Ward  
*Executive Administrator*

Jack Hunt, *Vice Chairman*  
Thomas Weir Labatt III, *Member*  
James E. Herring, *Member*

July 18, 2007

Mr. A. G. Swan  
Chair  
Parker County Utility District No. 1  
P.O. Box 1724  
Springtown, TX 76082

Re: Regional Wastewater Facility Planning Grant Contract between the Texas Water Development Board (BOARD) and Parker County Utility District No. 1, City of Aledo, Town of Annetta, City of Hudson Oaks, Town of Annetta North, City of Fort Worth, Town of Annetta South, City of Weatherford, and Tarrant Regional Water District (CONTRACTOR(S)) for Regional Wastewater Facility Planning, TWDB Contract No. 0604830608, Comments on Draft Final Report entitled "Regional Wastewater Planning Study for Eastern Parker County"

Dear Mr. Swan:

Staff members of the Board have completed a review of the draft report under Board Contract No. 0604830608. The review comments are enclosed. As stated in the above-referenced contract, the Contractors will consider addressing review comments from the EXECUTIVE ADMINISTRATOR (shown in Attachment I), as well those of other reviewers into the Final Report. The Contractors must include a copy of Attachment I in the final report.

The Board looks forward to receiving one (1) electronic copy of the entire FINAL REPORT in Portable Document Format (PDF) and nine (9) bound double-sided copies.

If you have any questions concerning this contract, please contact Ms. Kathleen Ligon, the Board's designated Contract Manager for this study, at (512) 463-8294.

Sincerely,

William F. Mullican, III  
Deputy Executive Administrator  
Office of Planning

c: Kathleen Ligon, TWDB

#### *Our Mission*

*To provide leadership, planning, financial assistance, information, and education for the conservation and responsible development of water for Texas.*

P.O. Box 13231 • 1700 N. Congress Avenue • Austin, Texas 78711-3231  
Telephone (512) 463-7847 • Fax (512) 475-2053 • 1-800-RELAYTX (for the hearing impaired)  
[www.twdb.state.tx.us](http://www.twdb.state.tx.us) • [info@twdb.state.tx.us](mailto:info@twdb.state.tx.us)

TNRIS - Texas Natural Resources Information System • [www.tnr.is.state.tx.us](http://www.tnr.is.state.tx.us)  
*A Member of the Texas Geographic Information Council (TGIC)*



**Attachment I**  
**Draft Report Comments, TWDB Contract No. 0604830608**  
**Regional Wastewater Planning Study for Eastern Parker County”**

1. The population projections used in this study are, in most cases, equivalent to TWDB approved projections. In cases where current growth patterns are outpacing TWDB projections, alternate projections from known reliable sources have been used. Overall, these projections appear to be reasonable for facility planning purposes.
2. On page 1-4 of the Executive Summary, last sentence of the last paragraph, we suggest changing the wording to explain the significance of the arrow on Figure 1-2 (better wording is found in the last sentence of the first paragraph on page 4-1 describing the same figure).
3. The number/ letter citation system is rather awkward. In the future we suggest using the author/date system instead (in fact, this may be required very soon for all TWDB reports).